

# EVOS™ M7000 Imaging System

For Fluorescence and Transmitted Light Applications

Catalog Number AMF7000

Doc. Part No. 710247

Publication Number MAN0018326

Revision C.0

Information in this document is subject to change without notice.

## DISCLAIMER

TO THE EXTENT ALLOWED BY LAW, THERMO FISHER SCIENTIFIC AND/OR ITS AFFILIATE(S) WILL NOT BE LIABLE FOR SPECIAL, INCIDENTAL, INDIRECT, PUNITIVE, MULTIPLE OR CONSEQUENTIAL DAMAGES IN CONNECTION WITH OR ARISING FROM THIS DOCUMENT, INCLUDING YOUR USE OF IT.

## Revision history MAN0018326

Revision	Date	Description
C.0	16 February 2021	Added "Chapter 6 – Analyze and annotate saved images", and revised Appendix C to add the EVOSt™ Analysis application section.
B.0	28 January 2020	Update the "Create and run automated scan" chapter and "Appendix C - Automate tab" section, and the relevant screens throughout the document. Add more information about Raw and Displayed images, and Tiled and Merged images.
A.0	17 December 2018	New user guide

## Important Licensing Information

These products may be covered by one or more Limited Use Label Licenses. By use of these products, you accept the terms and conditions of all applicable Limited Use Label Licenses.



**Manufacturer:** Life Technologies Corporation | 22025 20TH Ave SE | Bothell, WA 98021.

## Trademarks

All trademarks are the property of Thermo Fisher Scientific and its subsidiaries unless otherwise specified.

Cy is a registered trademark of GE Healthcare UK Limited. DRAQ5 is a registered trademark of Biostatus Limited. Windows is a registered trademark of Microsoft Corporation. Kimwipes is a registered trademark of Kimberly-Clark Corporation. Hoechst is a registered trademark of Hoechst GmbH. Swagelok is a registered trademark of Swagelok Company.

© 2021 Thermo Fisher Scientific Inc. All rights reserved.



# Contents

<b>About this guide</b> .....	<b>4</b>
<b>1. Product information</b> .....	<b>5</b>
Product description.....	5
Standard items included.....	7
Instrument exterior components .....	8
Computer ports and slots.....	10
Graphical user interface (GUI).....	11
<b>2. Installation</b> .....	<b>12</b>
Operating environment and site requirements .....	12
Prepare for installation .....	13
Set up.....	14
After installation is complete .....	16
<b>3. Capture and save images</b> .....	<b>19</b>
Overview .....	19
Capture images.....	20
Capture Z-Stack.....	33
Save .....	40
<b>4. Create and run automated scan</b> .....	<b>44</b>
Overview .....	44
Create a scan protocol.....	45
Run automated scan protocol.....	69
<b>5. Review saved images</b> .....	<b>71</b>
<b>6. Analyze and annotate saved images</b> .....	<b>75</b>
EVOS™ Analysis application .....	75
Image display settings .....	79
Grid .....	80
Scale bar .....	81
Histogram.....	82
Measurements and Annotations .....	83
Analyze cell culture.....	85
Count cells – Auto Count .....	86
Count cells – Manual Count.....	90
Measure confluence.....	92
Calculate transfection efficiency.....	95

Save analysis results.....	98
Batch Analysis.....	100
<b>7. Care and maintenance .....</b>	<b>103</b>
General care.....	103
Objective lens care.....	103
Stage care.....	104
Decontamination procedures.....	104
Calibrate the stage.....	105
Calibrate vessel.....	107
Change EVOS™ light cubes.....	111
Change the objectives.....	112
Calibrate the objectives.....	114
Install the shipping restraints.....	118
<b>Appendix A: Troubleshooting .....</b>	<b>120</b>
Image quality issues.....	120
Software interface issues.....	121
Mechanical issues.....	121
<b>Appendix B: System overview .....</b>	<b>122</b>
Technical specifications.....	122
Operation principles and technical overview.....	124
Image capture and save formats.....	125
<b>Appendix C: Graphical user interface (GUI).....</b>	<b>126</b>
Viewing area.....	127
Capture tab.....	139
Automate tab.....	157
Review tab.....	192
Settings.....	196
EVOS™ Analysis Application.....	215
<b>Appendix D: EVOS™ Onstage Incubator.....</b>	<b>224</b>
Technical specifications.....	225
EVOS™ Onstage Incubator components.....	226
Set up the EVOS™ Onstage Incubator.....	228
Use the EVOS™ Onstage Incubator.....	233

<b>Appendix E: Safety .....</b>	<b>236</b>
Safety conventions used in this document.....	236
Symbols on instruments .....	237
Safety labels on instruments .....	239
General instrument safety .....	240
Safety requirements for EVOS™ Onstage Incubator .....	241
Chemical safety .....	242
Chemical waste safety.....	243
Electrical safety .....	244
Physical hazard safety .....	245
Biological hazard safety.....	245
Safety and electromagnetic compatibility (EMC) standards .....	246
<b>Documentation and support.....</b>	<b>247</b>
Obtaining support .....	247

# About this guide

---

**Audience** This user guide is for laboratory staff operating, maintaining, and analyzing data using the Invitrogen™ EVOS™ M7000 Imaging System.

**User attention words** Two user attention words appear in this document. Each word implies a specific level of observation or action as described below.

---

**Note:** Provides information that may be of interest or help but is not critical to the use of the product.

---

**IMPORTANT!** Provides information that is necessary for proper instrument operation, accurate installation, or safe use of a chemical.

---

**Safety alert words** Three safety alert words appear in this document at points where you need to be aware of relevant hazards. Each alert word—**CAUTION**, **WARNING**, **DANGER**—implies a particular level of observation or action, as defined below:



**CAUTION!** – Indicates a potentially hazardous situation that, if not avoided, may result in minor or moderate injury. It may also be used to alert against unsafe practices.

---



**WARNING!** – Indicates a potentially hazardous situation that, if not avoided, could result in death or serious injury.

---



**DANGER!** – Indicates an imminently hazardous situation that, if not avoided, will result in death or serious injury. This signal word is to be limited to the most extreme situations.

---

# 1. Product information

---

## Product description

### EVOS™ M7000 Imaging System

The Invitrogen™ EVOS™ M7000 Imaging System (Cat. No. AMF7000) is a fully automated, digital, inverted multi-channel fluorescence and transmitted light imaging system. The system is designed for a broad range of applications including, but not limited to, multi-channel fluorescence imaging, multiple-position vessel scanning, area scanning with montage or tile stitching, and time-lapse imaging.

### EVOS™ M7000 Software

The EVOS™ M7000 Imaging System is controlled by the integrated Invitrogen™ EVOS™ M7000 Software accessed by the touchscreen monitor or the computer mouse and keyboard. The software comes pre-installed with the software shortcut placed on the desktop and under **Start ▶ All Programs ▶ Thermo ▶ M7000**.

Key features of the EVOS™ M7000 Software include:

- **Capture:** Allows control over every aspect of the system for image capture through a simple user interface. All images acquired can be saved in TIFF, PNG, C01, DIB, and JPEG formats, or compiled into a video sequence in AVI or WMV formats.
- **Automate:** Allows the creation, saving, and running of user-defined routines to automate image collection.
- **Autofocus:** Can be set up in five different modes to optimize speed and accuracy.
- **Tiled images and Image stitching:** Allow the scanning of an area to acquire multiple images to build tiled and stitched images. The Review tool allows zooming in/out and panning of the composite image. The entire scan or only regions of interest can be exported.
- **Z-stacking:** Captures a series of images along the z-axis that can be saved individually or combined into a Z-stack projection with a greater depth of field than any of the individual source images.
- **Time lapse:** Creates and runs time lapse movies based on user specifications.
- **Review:** Allows you to review captured images and analyze them with the EVOS™ Analysis application that is included in the EVOS™ M7000 Software package (page 6).

---

**Note:** For a detailed description of the EVOS™ M7000 Software controls, see “Appendix C: Graphical user interface (GUI)” (page 126).

---

## EVOS™ Analysis application

The EVOS™ Analysis application is a quantitative image analysis and annotation tool that runs independently from the EVOS™ M7000 software used for controlling the instrument. The application is included in the EVOS™ M7000 Software package.

Key features for the EVOS™ Analysis application include:

- **Analysis and annotation:** Allow you to change image display settings, toggle the display of grid and scale bar, display pixel intensity histogram, and annotate the image with basic geometric shapes and display dimensions, area, or perimeter information for the annotations.
- **Cell count:** Allows you to perform automatic or manual cell count in fluorescence mode post-acquisition.
- **Confluence:** Allows you calculate the percentage confluence of your culture based on selected reference objects and background.
- **Transfection efficiency:** Allows you to calculate the percentage of cells that express a fluorescence marker compared to the entire population.
- **Batch Analysis:** Allows you to save and apply the analysis parameters set in Auto Count, Confluence, and Transfection Efficiency tools to other images that you have collected and saved in an image folder

---

**Note:** For a detailed description of the EVOS™ Analysis application controls, see “EVOS™ Analysis Application” in “Appendix C: Graphical user interface (GUI)” (page 215).

---

## Standard items included

Before the EVOS™ M7000 Imaging System is installed (page 12), unpack the unit and accessories and verify all parts are present. Examine the instrument carefully for damage incurred during transit. Contact your distributor if anything is missing. Damage claims must be filed with the carrier; the warranty does not cover in-transit damage.

---

**Note:** If you do not have your distributor information, contact Technical Support (page 247).

---

- EVOS™ M7000 Imaging System
- Computer
- Touchscreen monitor
- Keyboard
- Mouse
- Accessories box (located in the instrument box), containing:
  - Power cable\*
  - \*For use with North American outlets; instruments intended for use outside North America must order a separate power cord.
  - Power supply
  - Display Port to Display Port cable
  - Mini-Display Port adapter
  - USB 3.0 type A to B cable
  - Dust cover
- Light cubes, as ordered
- Light cube tool
- Objectives, as ordered
- Vessel holder(s) for Well Plates (Cat. No. AMEP-VH022) and Double Slides (Cat. No. AMEP-VH021) and as ordered (located in the accessories box)
- Light box with cover (located in the accessories box)
- Sliders: Block slider, Diffuser slider
- USB flash drive (includes *User Guide and Quick Start Guide*)

---

**IMPORTANT!** Wiping the computer supplied with the EVOS™ M7000 Imaging System (i.e., erasing the hard drive to remove all programs, files, and the operating system) voids the product warranty. Do not install third party software or update the Windows™ operating system.

---

# Instrument exterior components

Top view

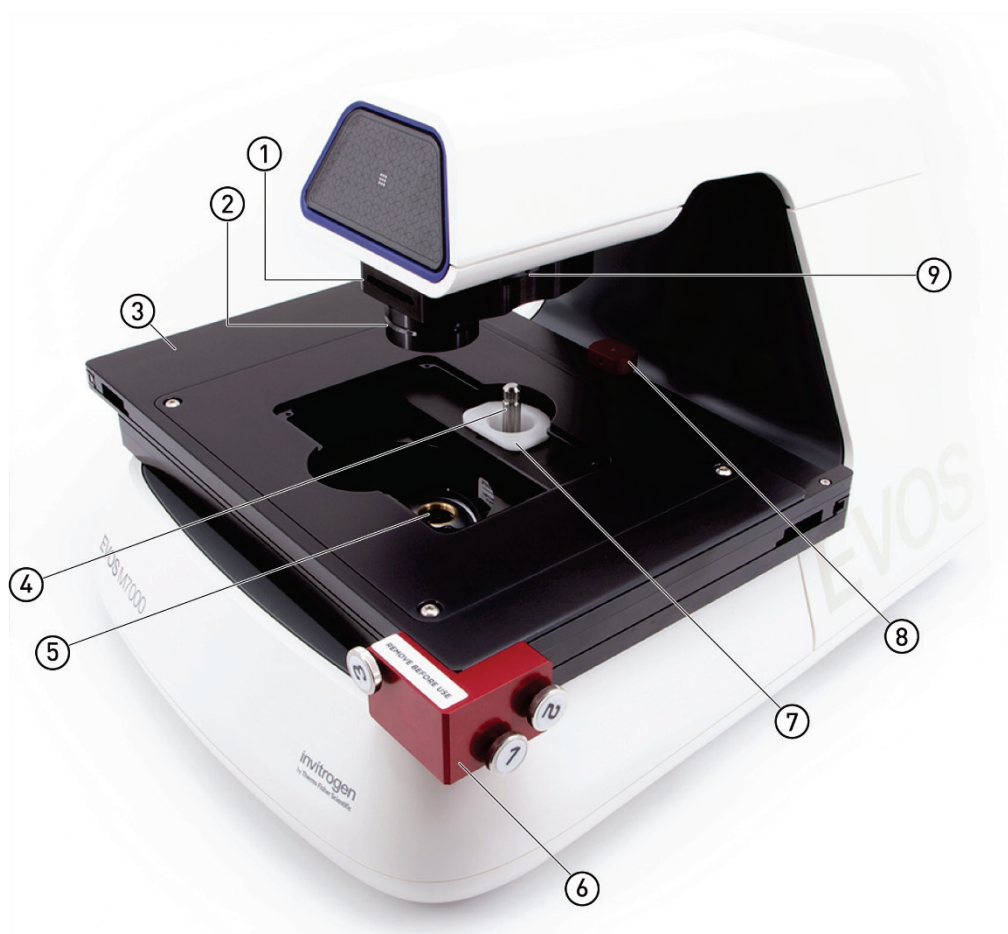

- ① Condenser slider slot
- ② Condenser
- ③ Automatic X-Y axis stage
- ④ Light cube tool
- ⑤ Objective turret (accommodates up to 5 objectives)
- ⑥ X-Y stage shipping restraint
- ⑦ Light cube shipping restraint
- ⑧ Camera shipping restraint
- ⑨ Phase annuli selector



Side view



- ① Condenser
- ② Automatic X-Y axis stage
- ③ Handholds

Rear view



- ① Power switch
- ② 4-pin power input port (24 VDC, 5 A)
- ③ USB 3.1 Type B port

## Computer ports and slots

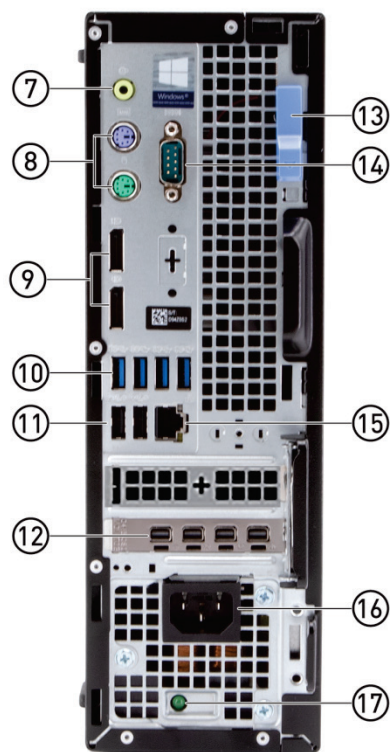
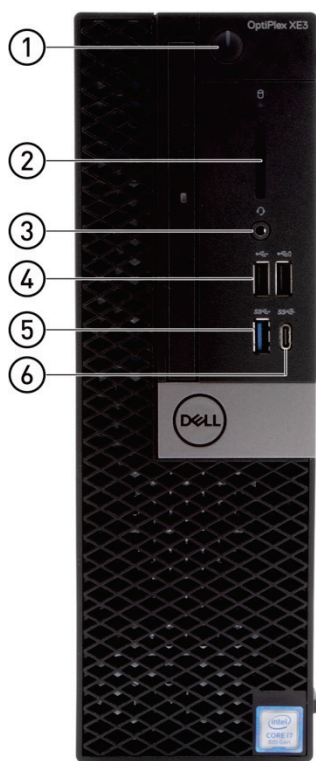

- ① Power button
- ② Media card reader
- ③ Universal audio jack
- ④ USB 2.0 Type A port (2×)  
(1 with PowerShare)
- ⑤ USB 3.1 Gen 1 Type A port
- ⑥ USB 3.1 Gen 2 Type C port  
(with PowerShare)
- ⑦ Line-out
- ⑧ PS/2 (6-pin mini DIN) port (2×)

- ⑨ Display port (2×)
- ⑩ USB 3.1 Gen 1 Type A port (4×)
- ⑪ USB 2.0 Type A ports (2×)
- ⑫ Mini Display port (4×)
- ⑬ Release latch
- ⑭ Serial port (9-pin D)
- ⑮ Ethernet port (RJ45)
- ⑯ Power input
- ⑰ Power supply diagnostic button

# Graphical user interface (GUI)

The functions of the EVOS™ M7000 Imaging System is controlled by the integrated Invitrogen™ EVOS™ M7000 Software through a graphical user interface (GUI), which is accessed by the touchscreen monitor or the computer mouse and keyboard.

## GUI layout

The GUI of the system consists of the Viewing area on the left and a series of tabs representing the main functions of the software (Capture, Automate, Review, and Settings) on the right. Each tab contains the controls necessary to execute the selected function. The Locations button, Area/Field View toggle, and the Zoom slider are located above the Viewing area.

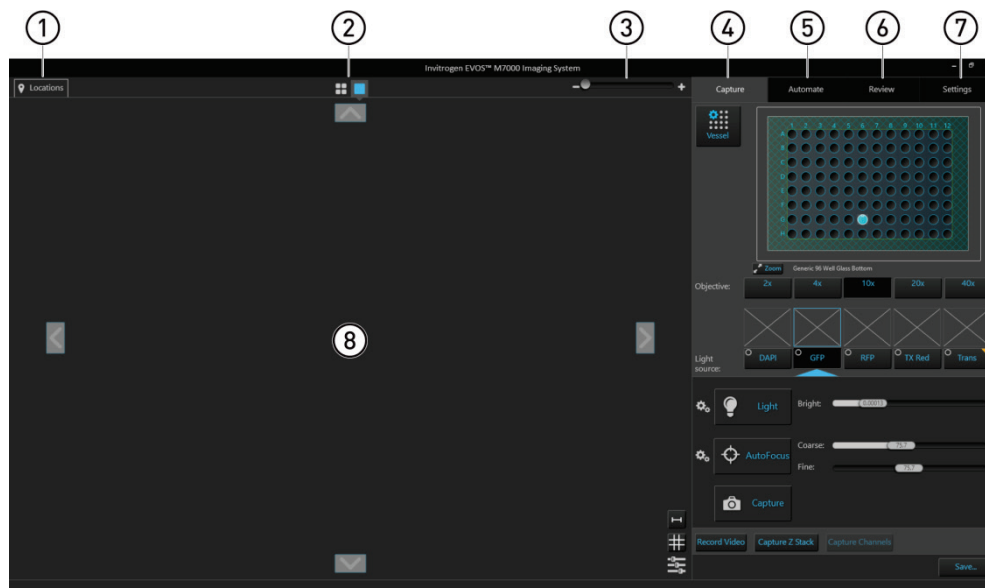

- ① **Locations:** Opens the Locations controls, which allows you to select location for automated scan protocols.
- ② **Area View/Field View toggle:** Switches between Area and Field Views.
- ③ **Zoom slider:** Zooms in and out of the Viewing area.
- ④ **Capture tab:** Contains the controls for the manual capture of images.
- ⑤ **Automate tab:** Allows you to create and run automated scan protocols and time lapse experiments.
- ⑥ **Review tab:** Allows you to review and annotate captured images.
- ⑦ **Settings:** Contains controls to select and adjust basic and advanced system options and instrument functions.
- ⑧ **Viewing area:** Displays the sample in Area View or Field View modes.

**Note:** Click the **View Help Content** icon to open the Help window, which provides EVOS™ M7000 Imaging System Help.



Position your pointer over the **Tooltip** icon without clicking it to view additional information.



**Note:** For more information and detailed descriptions of software controls, see “Appendix C: Graphical user interface (GUI)”, page 126.

## 2. Installation

---

**IMPORTANT!** Do not perform the initial installation of the EVOS™ M7000 Imaging System yourself. A Thermo Fisher Scientific representative will contact you to schedule the installation.

When the installation is scheduled:

1. Receive and inspect the system.
  2. Move the crated instrument to the installation site.
- 

### Operating environment and site requirements

- The EVOS™ M7000 Imaging System has a footprint of approximately 92 cm × 92 cm (36 in × 36 in); entire system includes the instrument, computer, and 23-inch touchscreen, high-resolution LCD monitor.
- The dimensions (L × W × H) of the EVOS™ M7000 instrument are 45.7 × 33.0 × 35.6 cm (18 × 14 × 13 in).
- If the system includes the optional EVOS™ Onstage Incubator (Cat. No. AMC1000), then add 40 cm (15.8 in) to the width of the bench, for a total bench width of ~132 cm (51.8 in).
- The EVOS™ M7000 Imaging System should be placed on a level surface away from vibrations from other pieces of equipment. Tabletop centrifuges, vortex mixers and other laboratory equipment can vibrate the instrument during a run that can cause a decrease of instrument performance.
- Allow at least 5 cm (2 in) free space at the back of the instrument to allow for proper ventilation and prevent overheating of electronic components.
- The EVOS™ M7000 Imaging System should be installed away from direct light sources, such as windows. Ambient room lighting can enter the imaging path and affect the image quality.
- Operating temperature range: 4°–32°C (40°–90°F).
- Relative humidity range: 30–90%.
- Operating power: 100–240 VAC, 1.8 A
- Frequency: 50–60 Hz
- Electrical input: 24 VDC, 5 A

---

**IMPORTANT!** Do not position the instrument so that it is difficult to turn off the main power switch located on the back of the instrument base (page 9). In case of an instrument malfunction, turn the main power switch to the OFF position and disconnect the instrument from the wall outlet.

---

## Prepare for installation

### Receive and inspect the shipment

1. Verify that the items shown on the shipping list are the same items that you ordered at the time of purchase.
2. Carefully inspect the shipping containers and report any damage to the Thermo Fisher Scientific service representative. Record any damage or mishandling on the shipping documents.
3. Unpack the instrument and accessories and verify all parts are present.  
See “Set up”, page 14, for detailed instructions on how to unpack the instrument and accessories.  
See page 7 for the list of standard items included in the shipment.
4. Examine the instrument carefully for damage incurred during transit. Contact your distributor if anything is missing. Damage claims must be filed with the carrier; the warranty does not cover in-transit damage.

---

**IMPORTANT!** Do not lift the EVOS™ M7000 Imaging System by stage or condenser arm. Lift the instrument by using the handholds in the base.

---

### Move the instrument to the installation site

1. Clear the installation site of all unnecessary materials.
2. If possible, move the crated instrument and other shipping containers to the installation site.



**CAUTION! PHYSICAL INJURY HAZARD.** Do not attempt to lift or move the instrument without the assistance of others, the use of appropriate moving equipment, and proper lifting techniques. Improper lifting can cause painful and permanent back injury. Depending on the weight, moving or lifting an instrument may require two or more persons

---

**IMPORTANT!** Do not subject the EVOS™ M7000 Imaging System to sudden impact or excessive vibration. Handle the instrument with care to prevent damage.

---

## Set up

---

**IMPORTANT!** The following set-up instructions are provided for informational purposes only. Do **not** attempt the initial set-up of the instrument on your own. The initial set-up of the EVOS™ M7000 Imaging System will be performed by your Thermo Fisher Scientific service representative, who will also provide some basic operator training.

---

### Unpack and connect the monitor

1. Open the case and remove the monitor and accessories.
2. If a VGA cable is attached to the monitor, take it off.
3. Remove protective covering from monitor.
4. Plug the USB touch screen cable into the USB port on the monitor.
5. Plug power cord into monitor.

### Unpack and connect the computer

1. Open the box and remove the keyboard.
2. Unpack the keyboard from its box.
3. Unpack the computer.
4. Unpack the mouse and power cord from the accessory holder.
5. Plug in the mouse and keyboard into USB 3.1 Type A ports (blue) on the back of the computer (page 10).
6. Plug the USB cord already connected to the monitor into a USB 3.1 Type A port (blue) on the back of the computer (page 10).
7. Plug in the power cord into the computer.

---

**IMPORTANT!** Wiping the computer supplied with the EVOS™ M7000 Imaging System (i.e., erasing the hard drive to remove all programs, files, and the operating system) voids the product warranty.

---

### Unpack and connect the instrument

1. Open the box and remove the accessory box.
2. Carefully lift the instrument out of the box, holding it by two of the four handholds in the base (page 9).

---

**IMPORTANT!** Do not lift the EVOS™ M7000 Imaging System by stage or condenser arm. Lift the instrument by using the handholds in the base.

---

3. Place the instrument on a flat, level surface that will be free from vibration and leave enough room around it for the stage to move freely.
4. Remove the following from the accessory box (located in the instrument box):
  - Power cable (for North America and as ordered)
  - Power supply
  - Display Port to Display Port cable
  - Mini-Display Port adapter
  - USB 3.1 type A to B cable
  - White cardboard box (contains the light box and vessel holders)
  - Dust cover
5. Confirm that the power switch is OFF (located on the back; page 9).

6. Attach the Mini-Display Port adapter to the Display Port-to-Display Port cable, then connect the cable to the Mini Display Port output on the computer (page 10) and the DVI input on the monitor.
7. Use the USB 3.1 type A to B cable to connect the blue USB 3.1 Type B port on the back of the instrument (page 9) to a USB 3.1 Type A port (blue) on the back of the computer (page 10).
8. Plug the power cable into the power supply and check for the light on the power supply.
9. Plug the power supply connector into the instrument.

---

**Note:** At this point, everything should be plugged in and OFF. Save the packaging for future shipping/storage of the instrument.

---

## After installation is complete

### Training

When the installation of the EVOS™ M7000 Imaging System is complete, the Thermo Fisher Scientific service representative will perform installation tests. During and/or after installation, the Thermo Fisher Scientific service representative will provide basic operator training. For additional training and reference information, see the user documents provided with the instrument.

### Remove shipping restraints

The EVOS™ M7000 Imaging System is equipped with three shipping restraints (X-Y stage, light cube, and camera shipping restraints), which prevent damage to the instrument from shock and vibration during transport. The shipping restraints must be removed before the EVOS™ M7000 Imaging System is powered on.

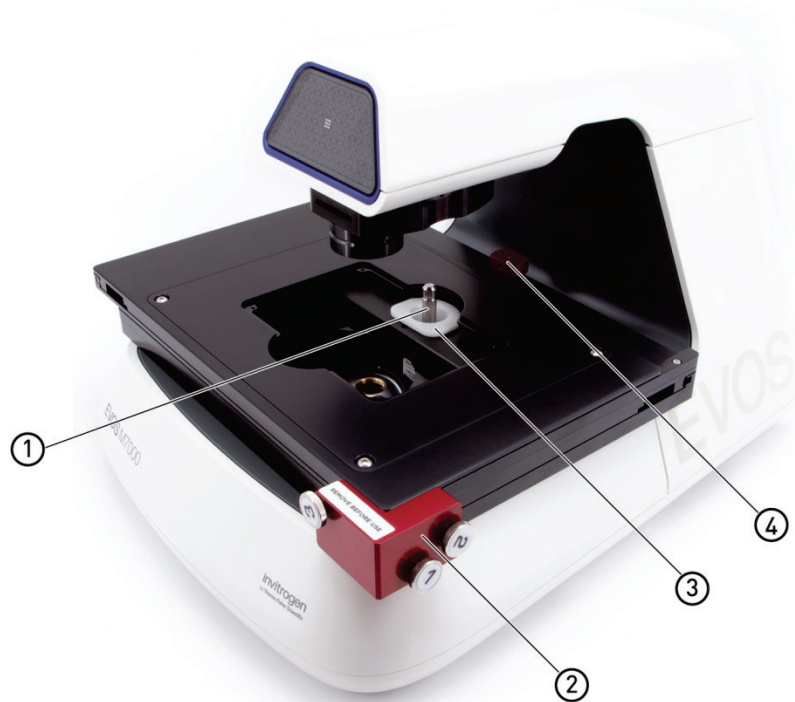

- ① Light cube tool
- ② X-Y stage shipping restraint
- ③ Light cube shipping restraint
- ④ Camera shipping restraint

1. Unscrew the three thumb screws on the X-Y stage shipping restraint until they spin freely. You do not need to remove them from the restraint altogether.
2. Gently pull the X-Y stage shipping restraint forward, away from the unit.

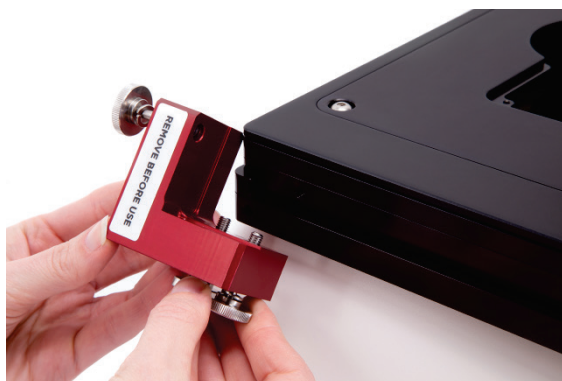



3. Unscrew the light cube tool (the metal cylinder) and remove the light cube shipping restraint (the white block) through the opening on the X-Y stage.



4. Unscrew the camera shipping restraint and pull it up to remove it from the X-Y stage.

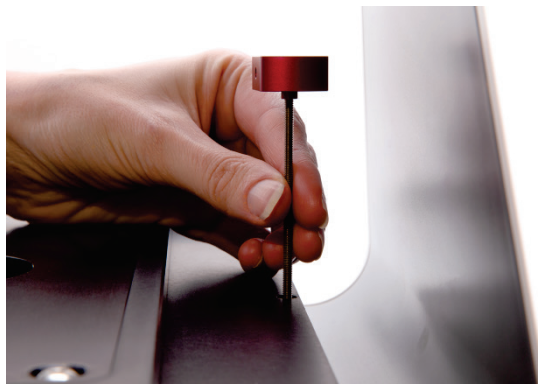

---

**Note:** Store the shipping restraints and the light cube tool in the accessories box for future use. To reinstall the shipping restraints, page 118.

---

**IMPORTANT!** Do not subject the EVOS™ M7000 Imaging System to sudden impact or excessive vibration. Handle the instrument with care to prevent damage.

---

## Turn ON the EVOS™ M7000 Imaging System

1. Turn the instrument power switch located in the back of the instrument base to the ON position.
2. Turn the computer and monitor ON.
3. When the computer shows the Windows™ desktop and the X-Y stage of the instrument has stopped moving, click the **M7000** icon on the desktop to start the EVOS™ M7000 software.
4. When the **Capture** tab is displayed, the EVOS™ M7000 Imaging System is ready to use.

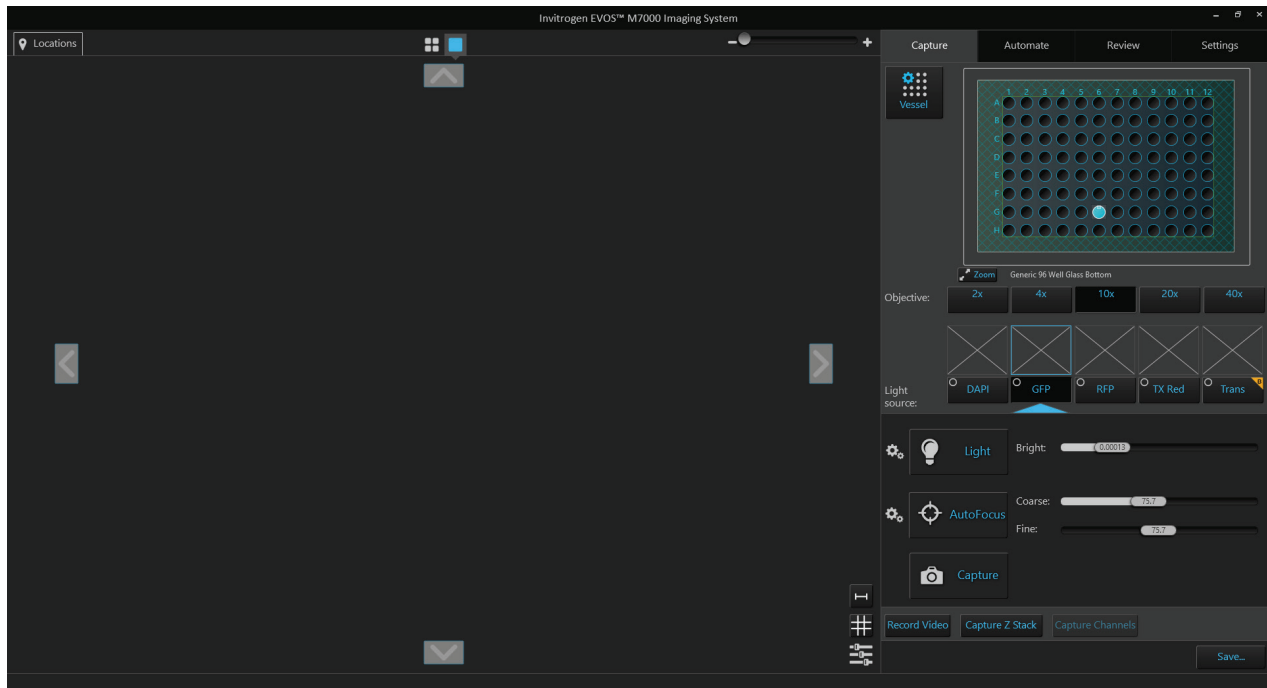
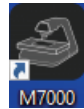

---

**IMPORTANT!** All shipping restraints must be removed before turning on the EVOS™ M7000 Imaging System to prevent damage (page 16).

---

## 3. Capture and save images

### Overview

#### Capture tab

The basic functions of the EVOS™ M7000 Imaging System, such as viewing the sample, setting optimal focus, and capturing and saving images are performed in the **Capture tab**, which is the first screen after start-up.

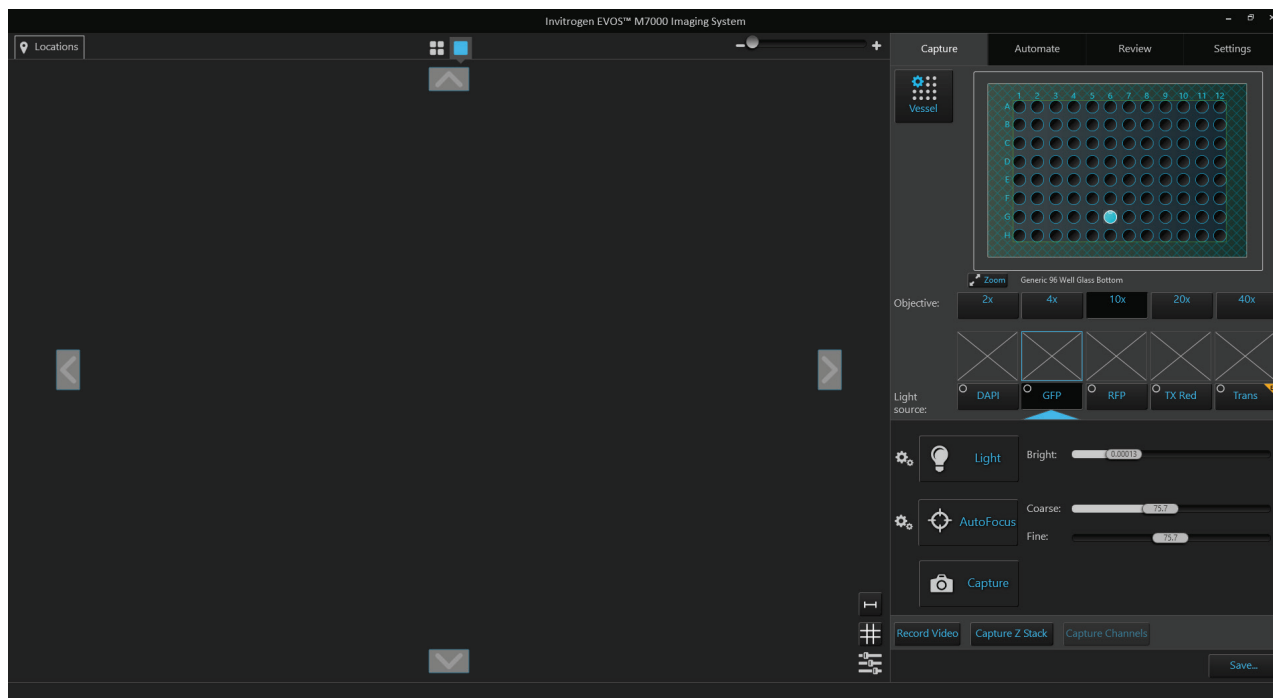

**Note:** For a detailed description of the Capture tab controls, see “Capture tab” in “Appendix C: Graphical user interface (GUI)” (page 139).

#### Workflow

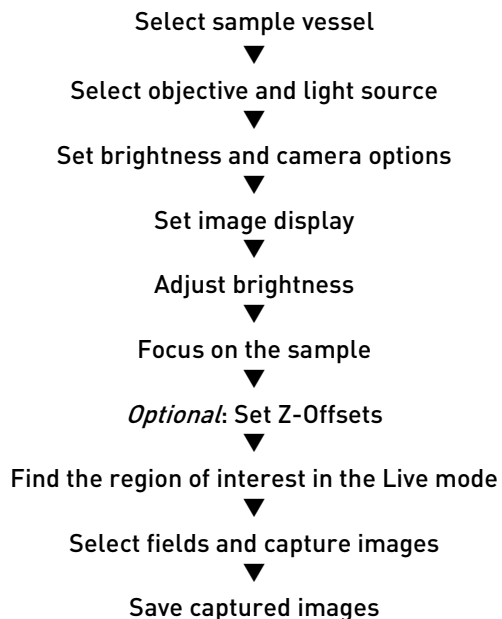

# Capture images

## Select sample vessel

2. Place the vessel containing your sample on the stage using the appropriate vessel holder.

**Note:** For the types of vessel holders available for the EVOS™ M7000 Imaging System, visit [thermofisher.com/evos](http://thermofisher.com/evos) or contact Technical Support (page 247).

2. On the **Capture tab**, click the **Vessel** button to open the Vessel Selection dialog.
3. Select the **Vessel category** that corresponds to your sample vessel. Available options are:

- **Well Plates**
- **Flasks**
- **Dishes**
- **Slides**

4. Select the appropriate **Holder** and **Vessel type** from the available dropdown menus.

**Note:** The Vessel Selection dialog is contextual; the dropdown menus display only the options available for the selected Vessel category.

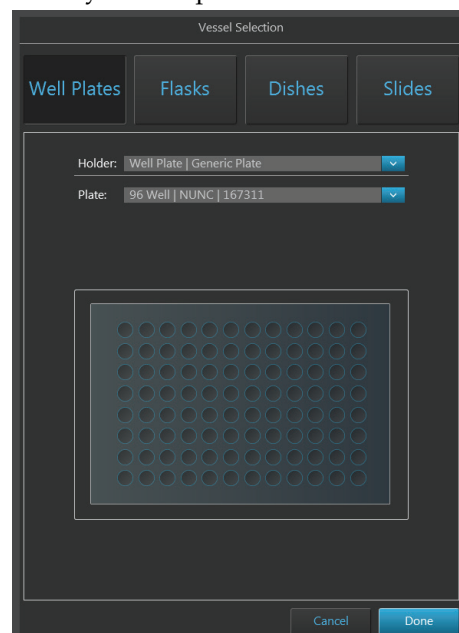
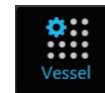

5. Click **Done** to complete your selection and close the dialog. The **Vessel map** on the Capture tab displays your selected vessel.

By default, the first well on the sample vessel is selected and indicated in blue on the Vessel map. The Viewing area displays the selected well.

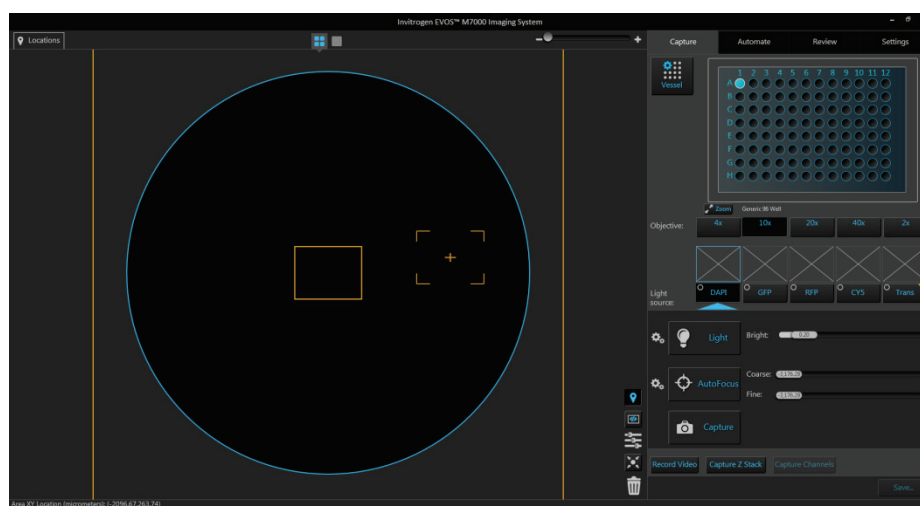

6. To select another well, click on the desired well on the **Vessel map**.

**Select objective and light source**

1. Click the desired **Objective** button to select the corresponding magnification. You can select only one objective at a time. In the example below, 10X objective has been selected.



2. Select the desired **Light source** from the available options for which you want to adjust brightness and set focus. In the example below, the DAPI channel has been selected.





---

**Note:** You can select only one light source at a time to adjust brightness and set focus. However, you can display and capture multiple channels simultaneously (see “Capture multiple channels simultaneously”, page 32).

---

**Set brightness and camera options**

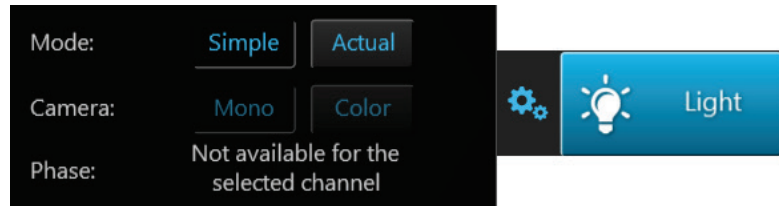
1. Click the **Brightness and camera settings** button to expand the controls for setting mode, camera, and phase options.



2. For **Mode**, select **Simple** or **Actual**.
  - **Simple** mode allows you to control **Brightness** as a single parameter.
  - **Actual** mode allows you to adjust **Light** (i.e., LED intensity), **Exposure**, and **Gain** parameters individually.
3. For **Camera**, select **Mono** (monochrome) or **Color**.
  - **Mono** is used for image capture in fluorescence and transmitted light (brightfield) channels
  - **Color** is used for image capture in the brightfield channel only
4. *Optional:* Choose **Phase** options. Available options are:
  - **Small Ring:** Used for objectives with low magnification (i.e., Olympus™ 4× PH)
  - **Medium Ring:** Used for objectives with medium magnification (i.e., EVOS™ 4×/10× PH)
  - **Large Ring:** Used for objectives with high magnification (i.e., EVOS™ 20×/40× PH)
  - **Brightfield** (phase contrast off)

---

**Note:** Phase options are available only for the transmitted light channel; they are not available for fluorescence channels. The phase contrast option does not require phase contrast objectives. However, to obtain a phase image, you must first install a phase contrast objective.

---

5. Click the **Brightness and camera settings** button again to collapse the controls.

## Adjust brightness

1. Click the **Light** button to turn on the excitation light for the currently selected light source and enter the instrument in the **Live mode**.



In the Live mode, the Viewing Area shows the sample illuminated with the selected light source and the image is displayed in pseudo-color in the default emission color.

2. Adjust brightness using the **Brightness** controls:
  - In the **Simple mode**, adjust the brightness by moving the **Brightness** slider in the desired direction.  
Alternatively, double-click the slider handle to activate the brightness text box and directly enter the desired brightness value (0%–100%).

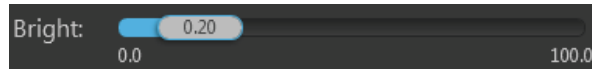

- In the **Actual mode**, adjust the brightness parameters individually by moving the **Light** (LED intensity), **Exposure**, and **Gain** sliders in the desired direction.  
Alternatively, double-click the slider handle to activate the corresponding text box and directly enter the desired value for the selected parameter (0%–100% for Light, 0–4.00 seconds for Exposure, or 1.0–8.0 for Gain).

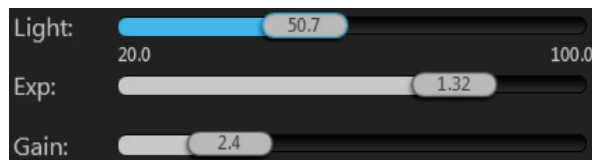

---

**Note:** For best results, optimize the brightness parameters as follows:

- **When searching for sample:** Increase **Gain** for a brighter signal and decrease **Exposure** for faster frame rate during navigation around the vessel.
- **When capturing image:** Decrease **Gain** to reduce background noise and increase **Exposure** to regain signal intensity, as needed.
- **For brighter signal:** Increase **Light** intensity for brighter illumination. If needed, follow by increasing **Gain**.
- **For time lapse imaging:** Increase **Gain** and **Exposure**, decrease **Light** intensity to reduce photobleaching and phototoxicity.

For example, for overnight time lapse experiments, capture one image every 30 minutes or less, limit the use of autofocus, and use a channel other than DAPI for autofocus.

---

## Set image display options

1. Select the **channels** you want display in the Viewing Area by clicking on the small circular checkboxes on the upper left of the corresponding **Light source** buttons.



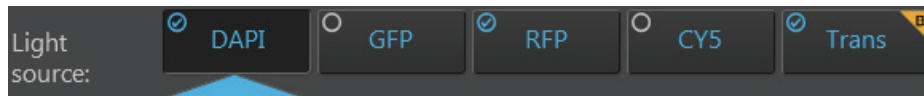

You can select multiple channels to display in the Viewing Area. In the example below, DAPI, RFP, and transmitted light (brightfield) channels have been selected.



2. Click **Image display settings** button to expand the controls for adjusting the image display parameters (brightness, contrast, gamma) for the selected channels.



**Note:** The controls for image display settings are contextual; only the controls for the selected channels will be available. In the example above, only the controls for the selected DAPI, RFP, and transmitted light (brightfield) channels are displayed.

3. *Optional:* To remove a channel from displaying in the Viewing Area, unselect the corresponding **Display**  checkbox. To display an available channel not shown in the Viewing Area, re-select the checkbox.
4. Adjust the **Brightness** , **Contrast** , and **Gamma**  settings for each of the selected channels using the corresponding sliders.
5. Click the **Image color display** button  to display the sample pseudo-colored in the default emission color of the selected channels. By default, color display option is on.
6. Click the **Image display settings** button again to collapse the controls.

---

**Note:** Adjustments made to Image display settings only affect how the image is displayed in the Capture tab; they do not change how the image is captured .

---



**Optional: Display scale bar**

1. Click the **Scale Bar** button to superimpose a scale bar over the Viewing area.

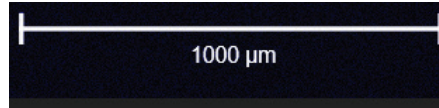

The size the scale bar represents depends on the magnification of the selected objective and it is displayed below the scale bar. After an image captured, the size of the scale bar automatically changes as you zoom on a captured image



No zoom

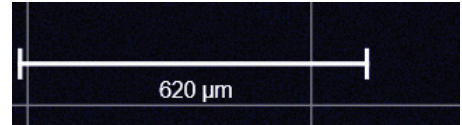

Zooming in on captured image

2. Click the **Scale Bar** button again to remove the scale bar from the Viewing area.

**Note:** The scale bar displayed in the Capture tab is not saved with your captured images. However, you can add a scale bar to your saved images with the EVOS™ Analysis application (page 75).

**Optional: Display grid**

1. Click the **Grid** button to superimpose a grid over the Viewing area.

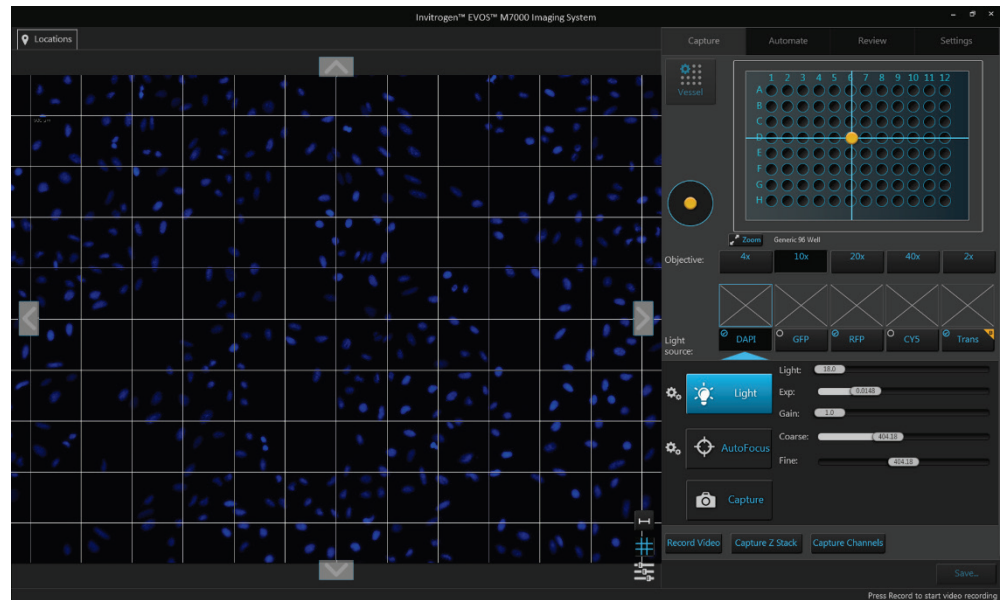

The scale of the grid depends on the magnification of the selected objective. The grid scale is displayed in the top left unit square.

2. Click the **Grid** button again to remove the grid from the Viewing area.

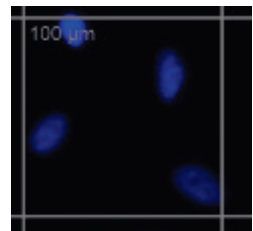

**Note:** To include a grid when you save your captured images, check the **Include Grid** option in the Save window and select the grid size (page 42). You can also add a grid to your saved images with the EVOS™ Analysis application (page 75).



## Focus on the sample

1. Click **Autofocus** to run the autofocus procedure to find the best focal plane for the current channel and sample. Alternatively, use the **Coarse** and **Fine** focus sliders to manually find the best focal position for the current channel and sample.

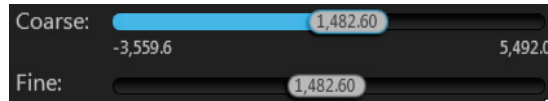
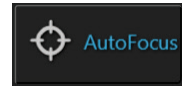

---

**Note:** If you run the autofocus procedure with the light off, the autofocused image will be captured and stored in the image cache for that channel. If you run the autofocus procedure with the light on (i.e., with the **Light** button pressed), the instrument will simply find the optimal focus, but will not capture the autofocused image.

---

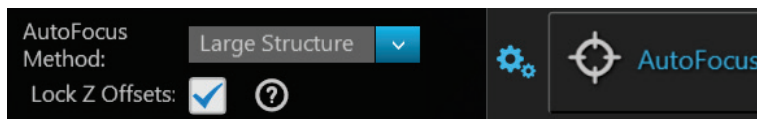

2. To choose a different autofocus method, click **Advanced focus settings** button located to the left of the Autofocus button, then select from the **AutoFocus Method** dropdown.



Available options are:

- **Fluorescence Optimized:** The focal plane is derived from the highest ratio between detailed, high-contrast objects against the background. This option is recommended for fluorescence imaging.
- **Transmitted Optimized:** The optimal focal plane is derived through statistics-based edge detection over 9 different regions to determine the highest ratio of edge-to-background. This option is recommended for transmitted-light imaging.
- **Small Structure:** This option is best for samples with many fine, hair-like structures (e.g., filaments or structural stains). This method computes the energy according to the size of image features and can measure the presence or absence of small size image features.
- **Large Structure:** Choose this option when your sample contains large structures (e.g., whole cell stains). This method is statistics-based and looks for large changes in image content as parts of the image go in and out of focus.
- **Small Bright Objects:** Choose this option when capturing samples with localized staining (e.g., nuclei). This method looks for brightness changes of the center of the cell and optimizes the focus on cells that have a bright center with a dark surrounding.

---

**Note:** To learn more about the autofocus strategy, click **Advanced focus settings** (the gear icon  next to the AutoFocus button in the Capture tab), then click the **View help content** icon  to open the Help window. In the Help window, click **How do I set Software Autofocus?**

---

**Optional: Set Z-Offsets**

Z-Offsets allow you to specify the optimal focus position in each channel relative to the focus position in other channels. Setting the correct Z-Offsets is especially important when the fluorescent markers in different channels are in different focal planes due to their normal localization in different cellular compartments.

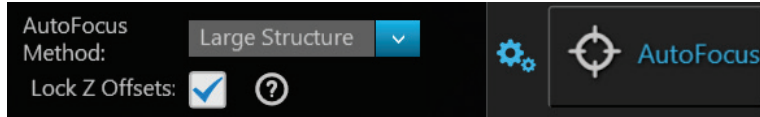

1. Verify that the **Lock Z-Offsets** option is checked in the Advanced focus settings window, then click the **Advanced focus settings** button again to close the window.

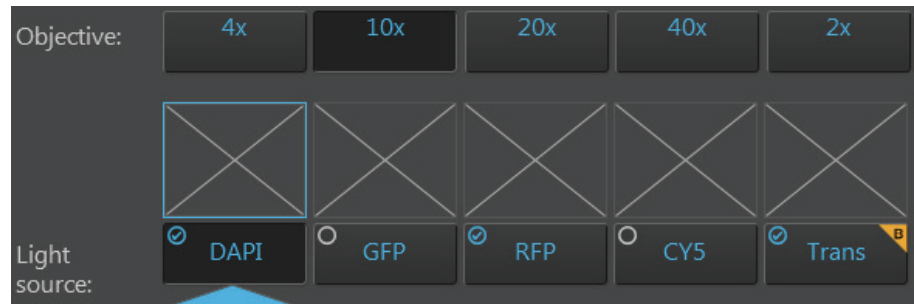

2. Select the **Objective** and **Light source** (i.e., channel) you want to capture.



---

**Note:** To learn more about locked and unlocked Z-Offset states and how to set the correct Z-Offsets, click **Advanced focus settings** (the gear icon  next to the AutoFocus button in the Capture tab), then click the **View help content** icon  to open the Help window. In the Help window, click **How do I set Z-Offsets?**

---

- Click the **Light** button to turn the light on and enter the Live mode.

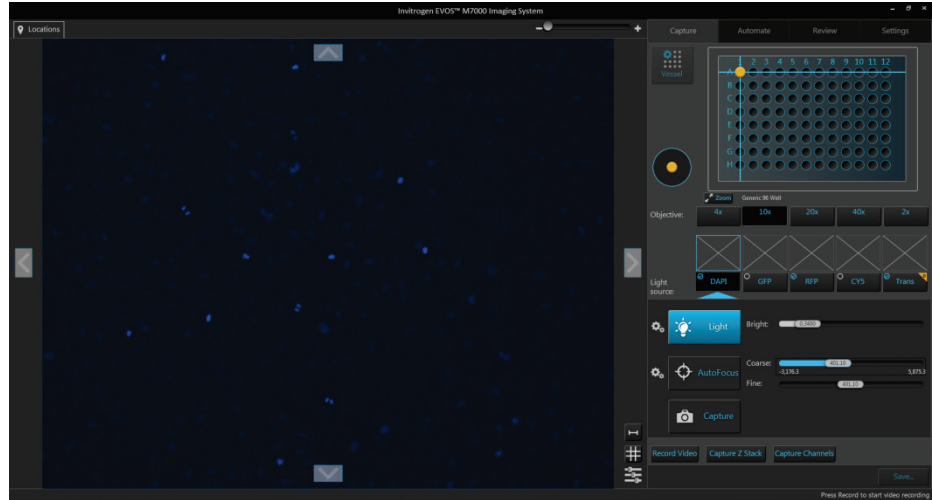

- Focus on the sample manually using the **Coarse focus** and **Fine focus** sliders or automatically by clicking the **AutoFocus** button.

You can also double-click on the handle of the focus slider to activate the text box and enter the desired value for the focus position.

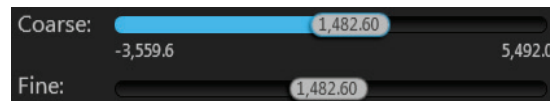

- After you have found the optimal focus position in the first channel, click the **Advanced focus settings** button, then uncheck the **Lock Z-Offsets** option.

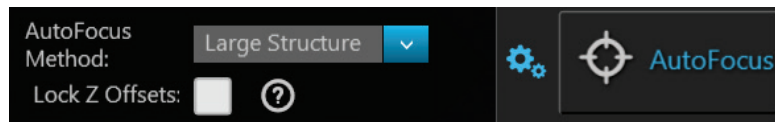

- Without changing the objective, select the next **Light source** (i.e., channel) you want to capture.
- If the light is off, click the **Light** button to turn it on, then focus on the sample manually using the **Coarse focus** and **Fine focus** sliders or automatically by clicking **AutoFocus**.
- Repeat this procedure for every channel you want to capture.
- When you have found the optimal focus position in all the additional channels you want to capture, click the **Advanced focus settings** button, then check the **Lock Z-Offsets** option.

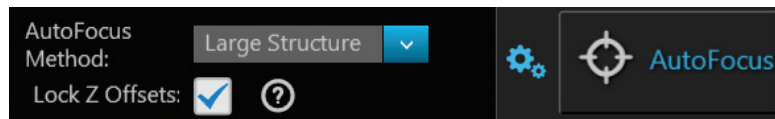

When you have completed this procedure, the focus position in each selected channel will be offset relative to each other.

Find the region of interest in the Live mode

1. While in Field View, click the **Light** button and enter the instrument in the **Live mode**.
2. To go to a specific location on the sample vessel, click and drag the **crosshair** to the corresponding location on the virtual vessel.

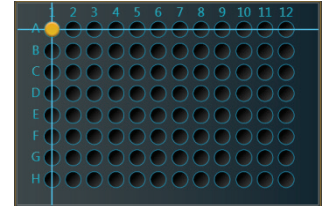

3. If needed, click on the **Zoom** button to open a larger view of the Vessel map for easier navigation to the desired location.

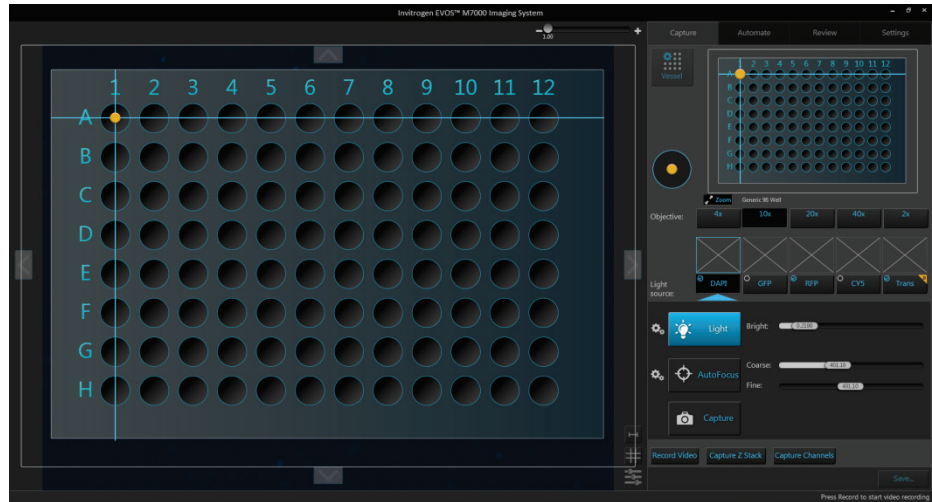
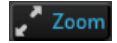

Click the **Zoom** button again to close the zoom window.

4. While in the **Live mode**, use the **Jog Control** to move the stage at an intermediate pace to the desired location as you view the sample until you find the field of view you want to capture.



Alternatively, click on the **navigation arrows (up, down, left, right)** on the Viewing area to move in the corresponding direction exactly one field of view. You can also click and drag the field of view itself to move around the sample vessel.

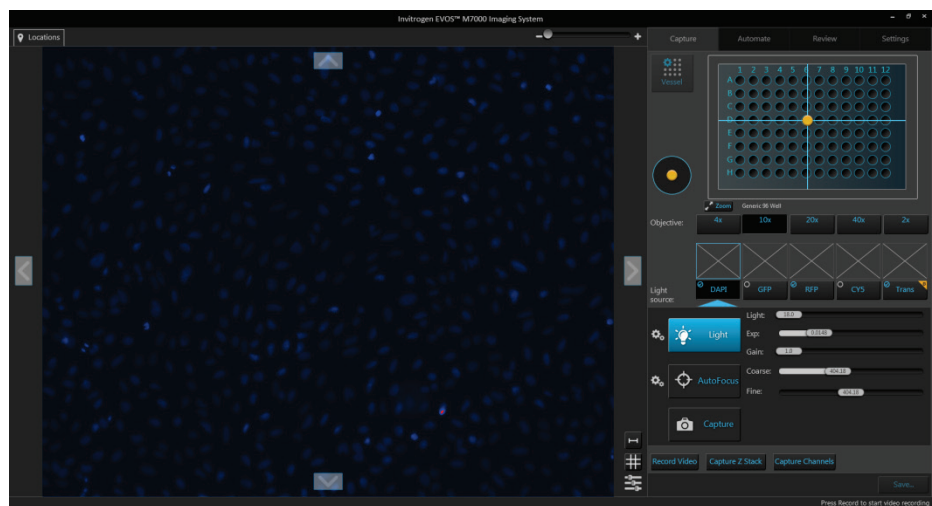

5. Click the **Light** button again to exit the Live mode in Field View.

## Select fields and capture images

1. In **Area View**, position the **capture crosshair** over the region of interest and click to select the field you want to capture.  
Alternatively, find the field you want to capture in the **Live mode**.

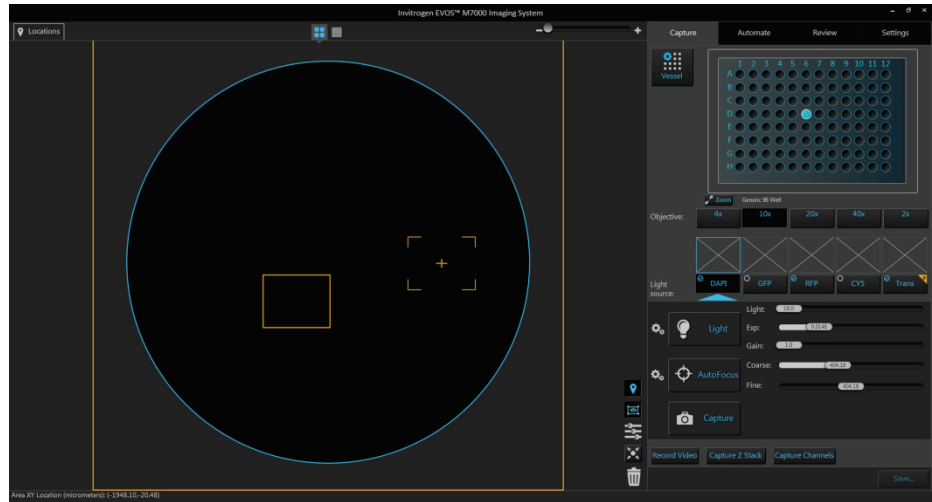

2. Click **Capture** to acquire an image of the selected field using the current capture settings.

A thumbnail of the captured image is displayed above the Light source button for the channel in which the image was captured (in this example, DAPI).

The Viewing area displays the captured image at the location of its capture when the zoom level is greater than one field of view.

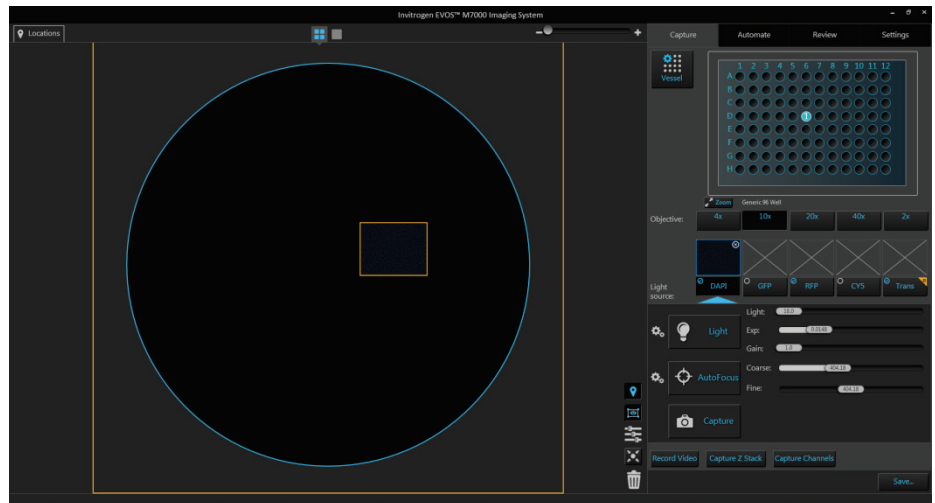

**IMPORTANT!** Captured images are stored in the memory buffer. If unsaved, newly captured images will overwrite the previously captured image in the selected channel for the selected field. Images captured in other fields and channels will not be affected.

- To capture the same field in another channel, select the desired channel using the corresponding **Light source** button.



- If needed, readjust **brightness** and **focus**, then click **Capture**.

A thumbnail of the captured image is displayed above the Light source button for the new channel in which the image was captured (in this example, RFP).

The Viewing area displays a multicolor overlay of the images captured in multiple channels at the location of their capture.

In this example, the second image was captured in the RFP channel, and the Viewing area displays a multicolor overlay of the images in the DAPI and RFP channels.

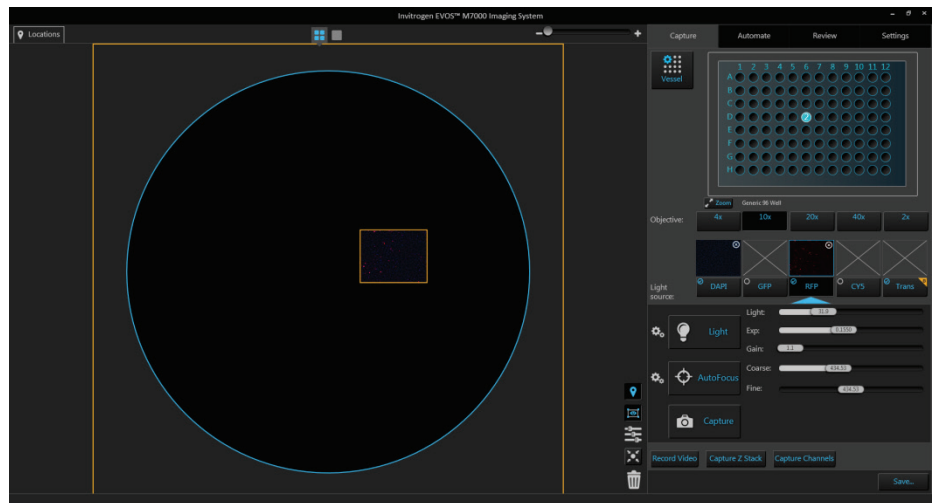

- To zoom in on the Viewing area, use the **Zoom slider** located above the Viewing area.

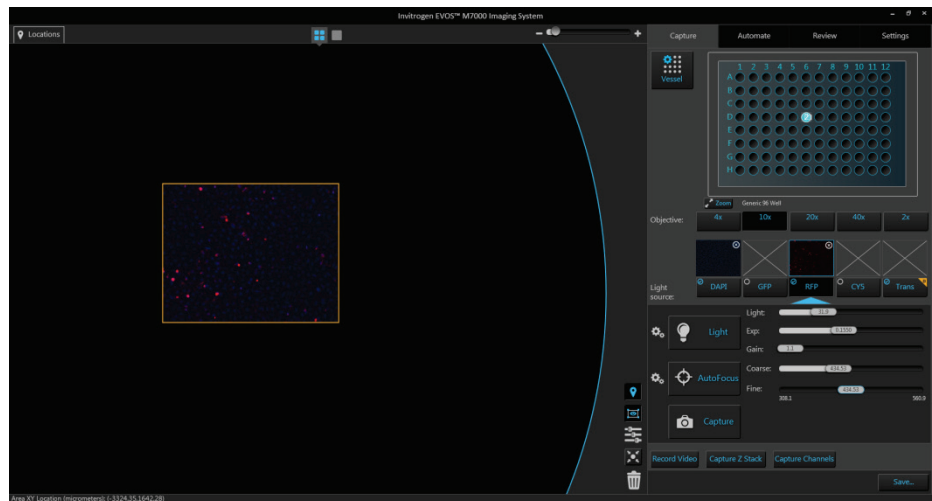



- To capture another field, position the **capture crosshair** over the new region of interest, and click to select the new field.  
Alternatively, find the new field you want to capture in the Live mode.
- Click the **Light source** button to select the corresponding channel, readjust **brightness** and **focus** (if needed), then click **Capture**.

In the example below, a second field was captured in the DAPI channel to the left of the first field, which was captured in DAPI and RFP channels.

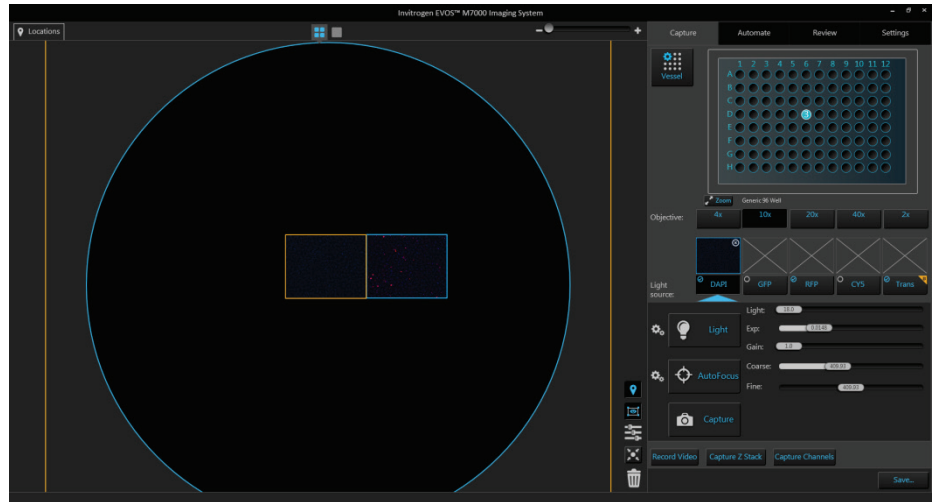

- To capture a field using a different magnification, select the desired **Objective**.



- Click the **Light source** button to select the corresponding channel. If needed, readjust **brightness** and **focus**.
- Position the **capture crosshair** over the new field of interest, click to select the new field, then click **Capture**.

In the example below, a third field located was captured in the DAPI channel using the 4X objective.

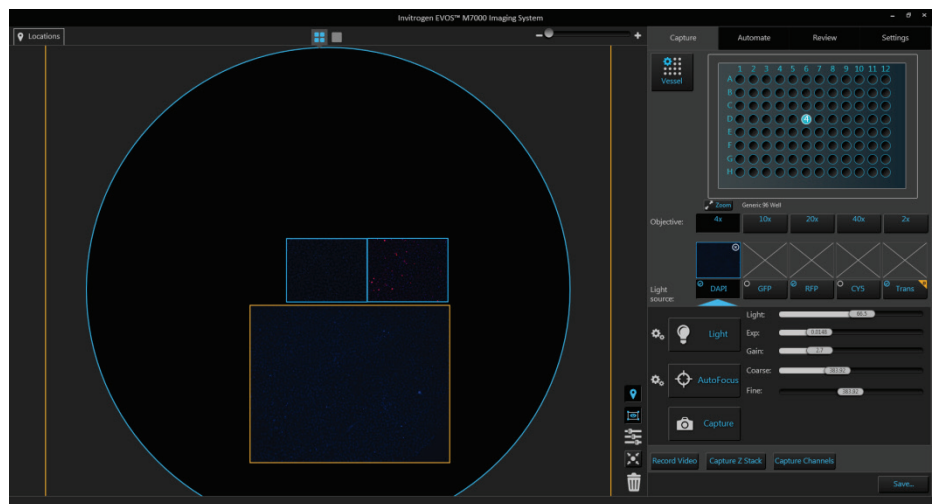

- To save your captured images, click **Save....** For more information, see “Save” (page 40).

**Capture multiple channels simultaneously**

- To capture a selected field in multiple channels simultaneously, check the **Toggle channel display** option for the channels you want to capture. The Toggle channel display checkboxes are located on the top left corner of the corresponding light source buttons. In the example below, DAPI and RFP channels have been selected.

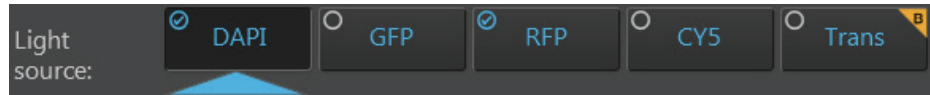

- Click the desired **Objective** button to select the corresponding magnification. You can select only one objective at a time. In the example below, 4X objective has been selected.



- Adjust **brightness** and **focus** for each of the selected channels as described before.
- Position the **capture crosshair** over the new region of interest, and click to select the new field. Alternatively, navigate to the region of interest you want to capture in the **Live mode**.
- Click **Capture Channels**. The instrument captures an image of the selected field in each of the selected channels using the current capture settings.

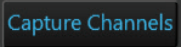

A thumbnail of the captured image is displayed above the Light source button for each channel in which it was captured.

The Viewing area displays a multicolor overlay of the images captured in the selected channels at the location of their capture.

In the example below, the selected field was captured in the DAPI and RFP channels using the 4X objective, and the Viewing area displays the merged image captured in these channels.

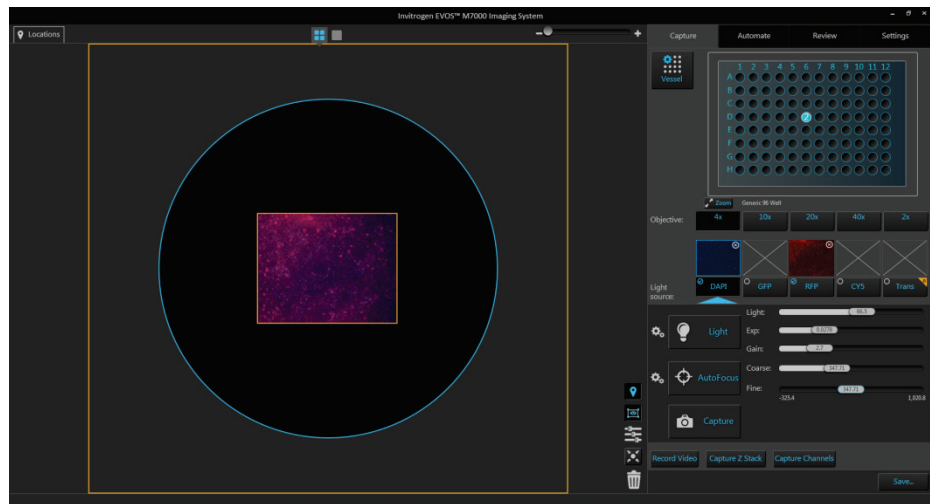

- To save your captured images, click **Save....** For more information, see “Save” (page 40).



# Capture Z-Stack

## Capture Z-Stack

Capture Z-Stack allows you to capture multiple images of a selected field at different focal planes along the z-axis and combine them to generate a final image with a greater depth of field than any of the individual source images.

1. Select the **Objective** and **Light source** (i.e., channel) you want to capture.

**Note:** You can capture z-stack images in only one channel at a time; however, you can save the z-stacks images captured individually in separate channels into a single merged video (see “Save Z-Stack as a video”, page 38).

2. Position the **capture crosshair** over the region of interest, then click to select the new field. Alternatively, navigate to the region of interest in the **Live mode**.
3. Adjust **brightness** and **focus** using the corresponding sliders on the Capture tab. The focus position you set in this step is the Default Focus position.

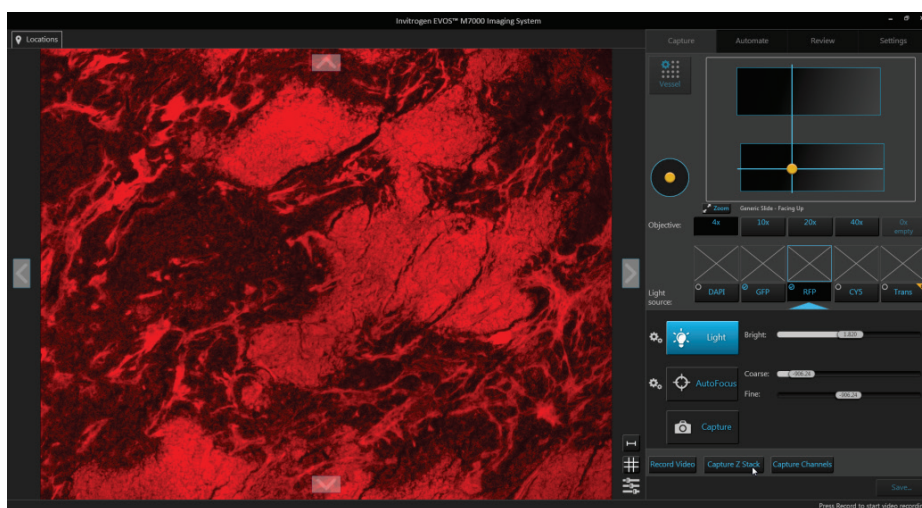

4. Click **Capture Z-Stack** to open the Z-Stack Settings window. You can move the Z-Stack Settings window anywhere on the screen.

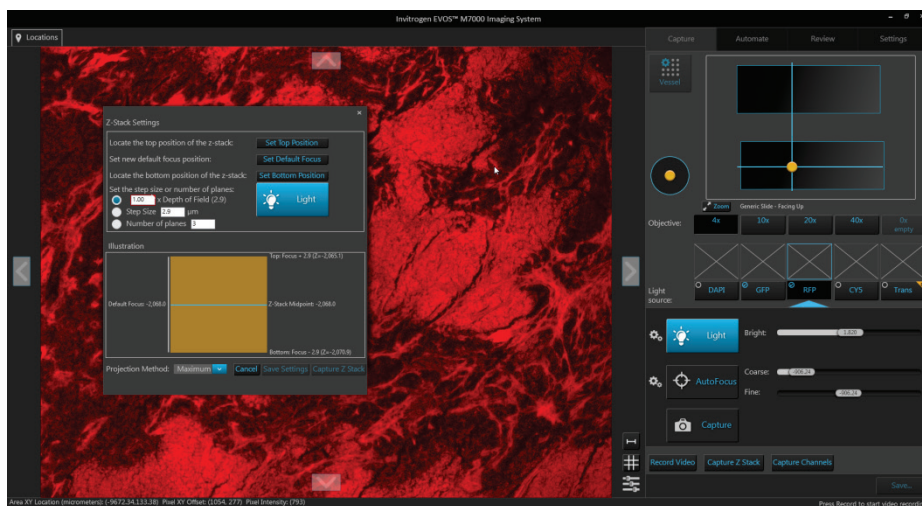

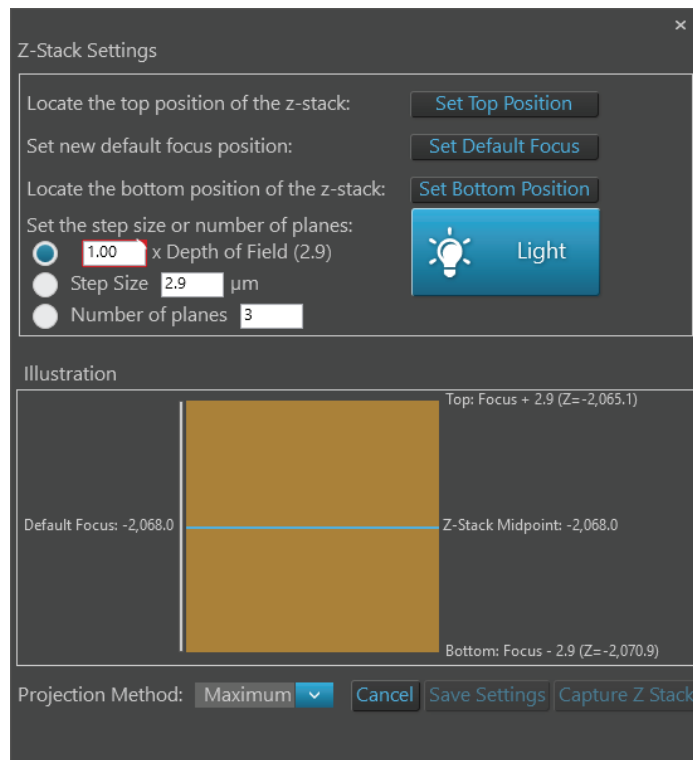

5. If not already on, click the **Light** button to illuminate the sample as you locate the top and bottom boundaries of the z-stack.
6. Using the **focus** sliders on the Capture tab, locate the top position of the z-stack, then click **Set Top Position**.
7. Repeat the procedure for the bottom position, then click **Set Bottom Position**. This sets the top and bottom boundaries of the z-stack image set.
8. Enter the **Step Size** (in  $\mu\text{m}$ ) or the **Number of planes**, or define the z-stack as a multiple of **Depth of Field**.  
These parameters determine the number of “optical sections” captured in the z-stack.
9. Select the **Projection Method** from the dropdown menu.  
This is the mathematical algorithm used to extract the most in-focus pixels from the images captured at different focal planes when generating the z-stack projection. Available options are:
  - **Maximum:** For fluorescent images that are bright on dark background.
  - **Standard deviation (StDev):** For unstained transmitted images where the objects are identified by the contrast instead of the intensity.
  - **Average:** For fluorescent or histochemically-stained transmitted images when assessing concentration of the stain/marker.
10. To save the z-stack parameters you have set up, click **Save**. This allows you to capture z-stack images in other channels using the same specifications.

- To capture the z-stack, click **Capture Z-Stack** in the Z-Stack Settings window. The instrument captures multiple images of the sample along the z-axis based on your specifications.

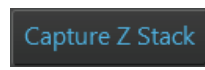

A thumbnail of the z-stack projection is displayed above the Light source button for the channel in which the z-stack images were captured.

The z-stack icon  on the top left corner of the thumbnail image identifies it as a z-stack projection.

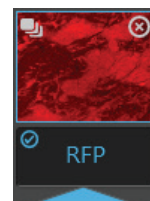

- The Area View displays the z-stack projection at the location of its capture. The z-stack icon  on the top left corner of the captured field identifies it as a z-stack projection.

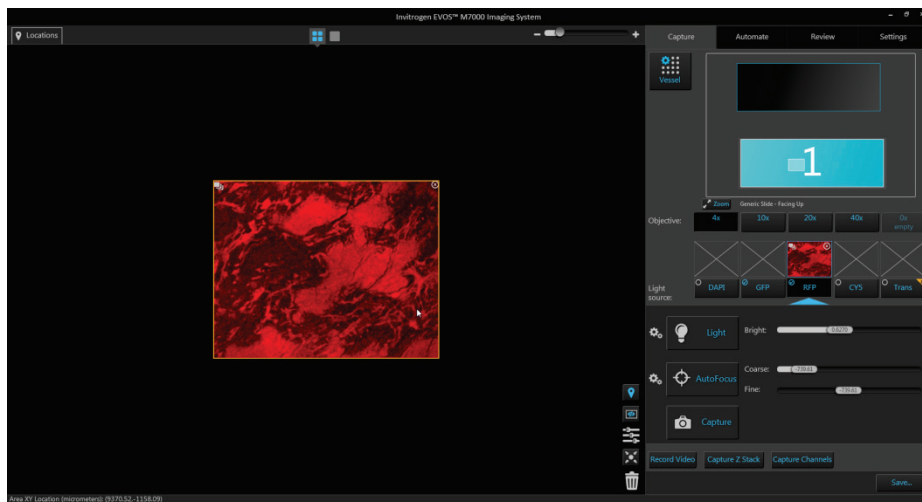

- To view the individual planes that make up the z-stack image set, double-click the field that shows the z-stack projection in Area View.



Alternatively, click the Field View icon. The Field View displays the z-planes and the z-stack controls appear to the left of the Viewing area.

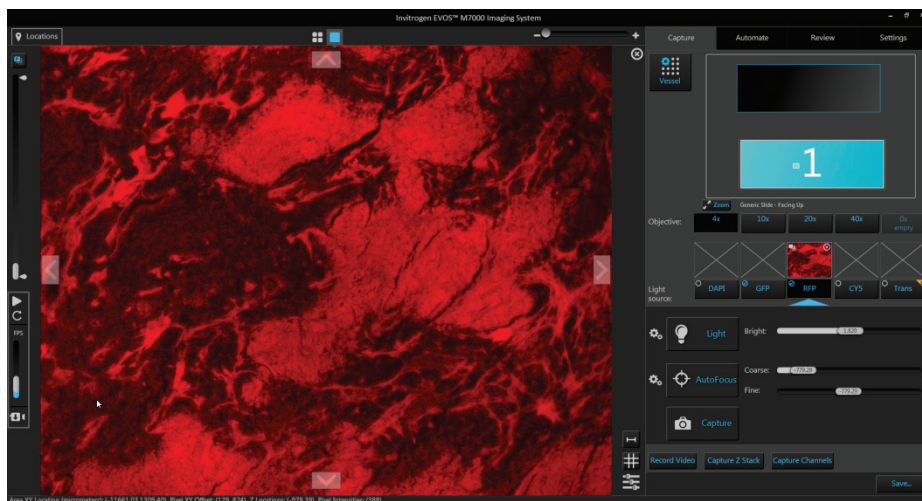

14. Move the **z-stack slider** up or down to view the z-planes (i.e., the “optical sections”) in the sequence they were captured.
  - Move the slider up to display the z-planes towards the top position of the z-stack.
  - Move the slider down to display the z-planes closer to the bottom position.
  - The z-slice number that is displayed above the slider handle as you move it up or down indicates the order of the plane within the z-stack.



15. To view the the z-stack projection, click the **Toggle Projection Image** button.



The Viewing area displays the z-stack projection, which is generated by combining the most in-focus pixels from each z-plane. By default, the projection image is on.

16. To view the z-planes in sequence as a movie, click the **Start z-stack playback** button located below the z-stack slider.

The Viewing area displays the z-planes in sequence, starting at the bottom slice (Z-plane: 1) and stopping at the top.



17. To play the z-stack movie in a loop, click the **Repeat playback** button.

The Viewing area displays the z-planes in a continuous loop, starting at the bottom slice and looping back to beginning after displaying the top slide.



- To change the playback speed, move the **Playback speed** slider up (faster) or down (slower). The playback speed is expressed in frames per second (FPS).



- To stop the z-stack movie, click **Stop z-stack playback**.



---

**Note:** During playback, z-planes that make up the z-stack are shown sequentially in the channel in which they were captured. The projection image is not displayed (i.e., the Toggle Projection Image is unselected).

---

18. To limit the z-stack movie to specific z-planes, drag the **z-stack calipers** to the desired z-planes to set upper and lower boundaries. When replaying the z-stack movie or saving it as a separate video file, only the z-planes that fall within the z-stack calipers are included in the video file.



19. To capture z-stack images in another channel, select the **Light source** (i.e., channel) you want to capture, then repeat the procedure as described.

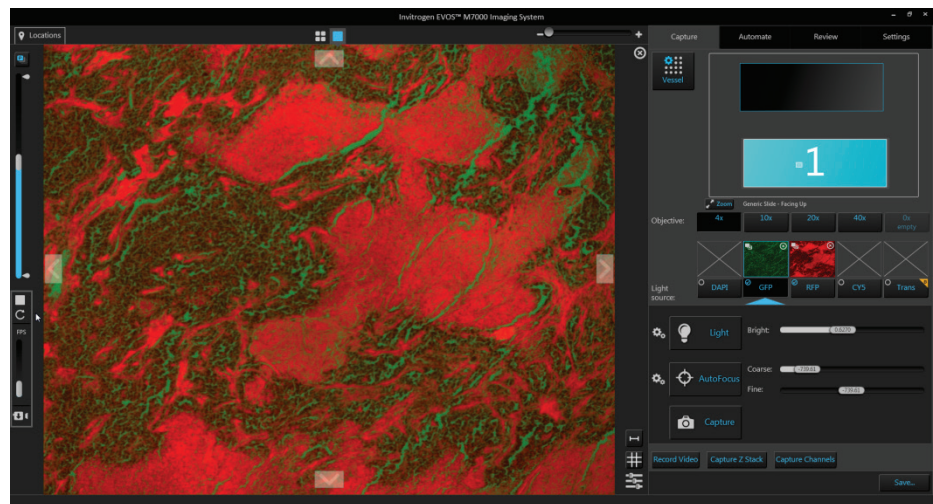

**Note:** To view the z-stack images captured in multiple channels as an overlay, check the **Toggle channel display** option for the channels you want to include in the overlay.

The Toggle channel display checkbox is located on the top left corner of the corresponding light source button. In the example below, GFP and RFP channels have been selected.

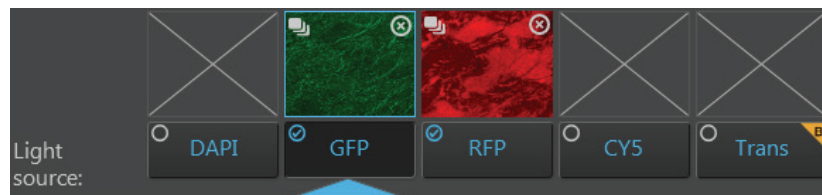

20. To save the z-stack movie as a separate file, see “Save Z-Stack as a video” (page 38).
21. To save the z-stack projection and individual z-planes for each field and each channel as separate images, click **Save...** to open the Save dialog. For more information, see “Save”, page 40.



## Save Z-Stack as a video

1. Check the **Toggle channel display** option for the channels you want to include in your z-stack video. In the example below, GFP and RFP channels contain z-stacks and both have been selected for the z-stack video.

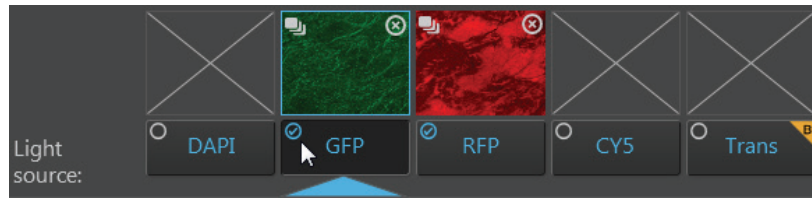

**Note:** Selected channels must contain captured z-stack images to be included in the z-stack video. If multiple channels with z-stacks are selected, the z-stack video displays an overlay of the z-stack images captured in different channels.

2. Click **Save as Video** icon to save the z-stack images as a video sequence. The Save Z-Stack Videos dialog opens.

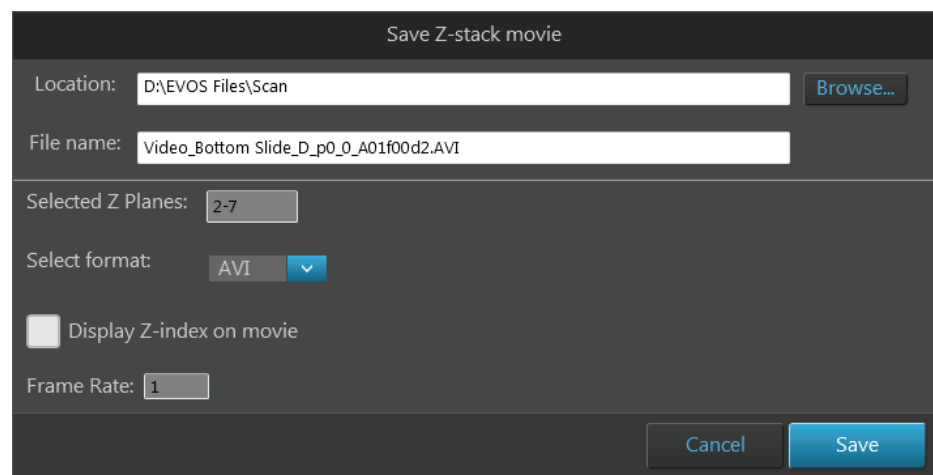

3. Click **Browse**, navigate to the folder in which you want to save your z-stack video, then click **Select**.

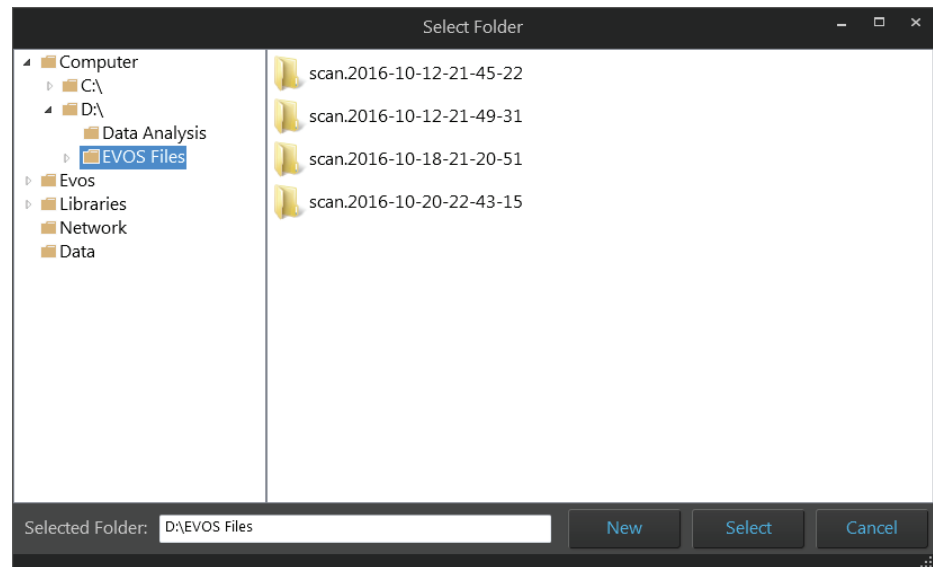

**Note:** We recommend that you save your captured images to an external hard drive.

Alternatively, click **New** to create a new folder at the desired location, type in the name of the newly created folder, then click **Select**.

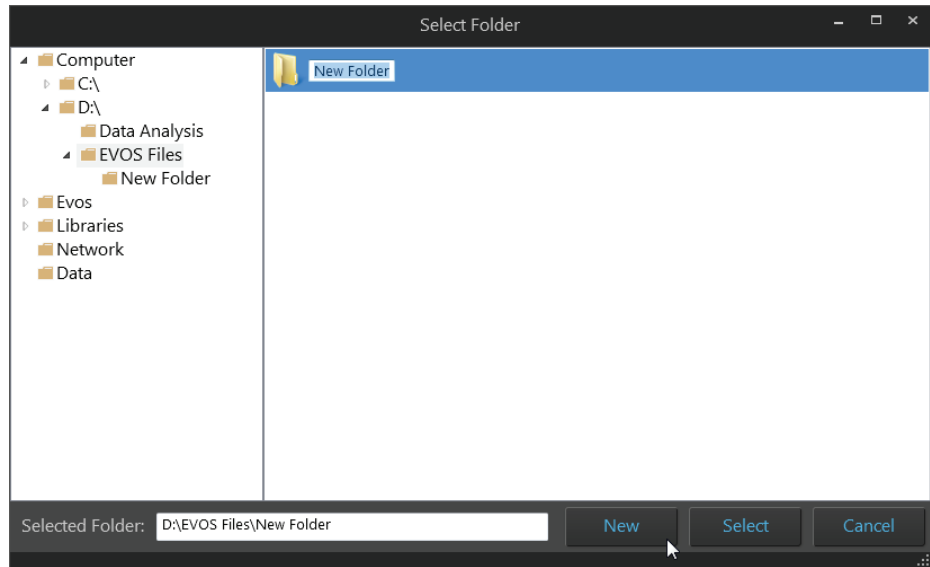

4. If desired, enter a new name for the z-stack video file in the **File name** textbox.



5. Confirm that the **Selected Z Planes** text box displays the correct z-indices for the planes that you want to include in your z-stack video.



**Note:** When saving the z-stack movie as a separate video file, only the z-planes that fall within the z-stack calipers are included in the movie. To change the z-planes you want to include in the z-stack movie, click **Cancel** and readjust the **z-stack calipers** as described on page 37.

6. Select the **file format** for the z-stack video from the dropdown menu. Available options are **AVI** and **WMV**.
7. To display the z-index of each plane (i.e., the order within the z-stack) in the video, check **Display Z-Index on movie**, then select the desired **Location**, **Font Size**, and **Font Color** from the drop-down menus. By default, this option is not checked.

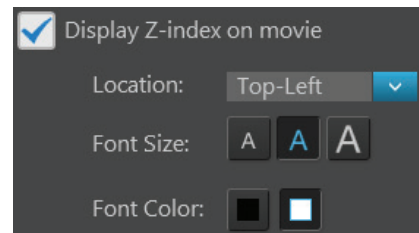

8. Confirm that the **Frame rate** text box displays the correct **Playback speed** for your z-stack video.

**Note:** The **Frame rate** of your z-stack video sequence is set using the **Playback speed** slider. To change the Frame rate for your z-stack movie, click **Cancel** and readjust the Playback speed slider as described on page 37.

9. Click **Save** to save the z-stack images as a video sequence based on your specifications.

# Save

## Save captured images

1. When finished capturing images, click **Save...** to open the Save window.

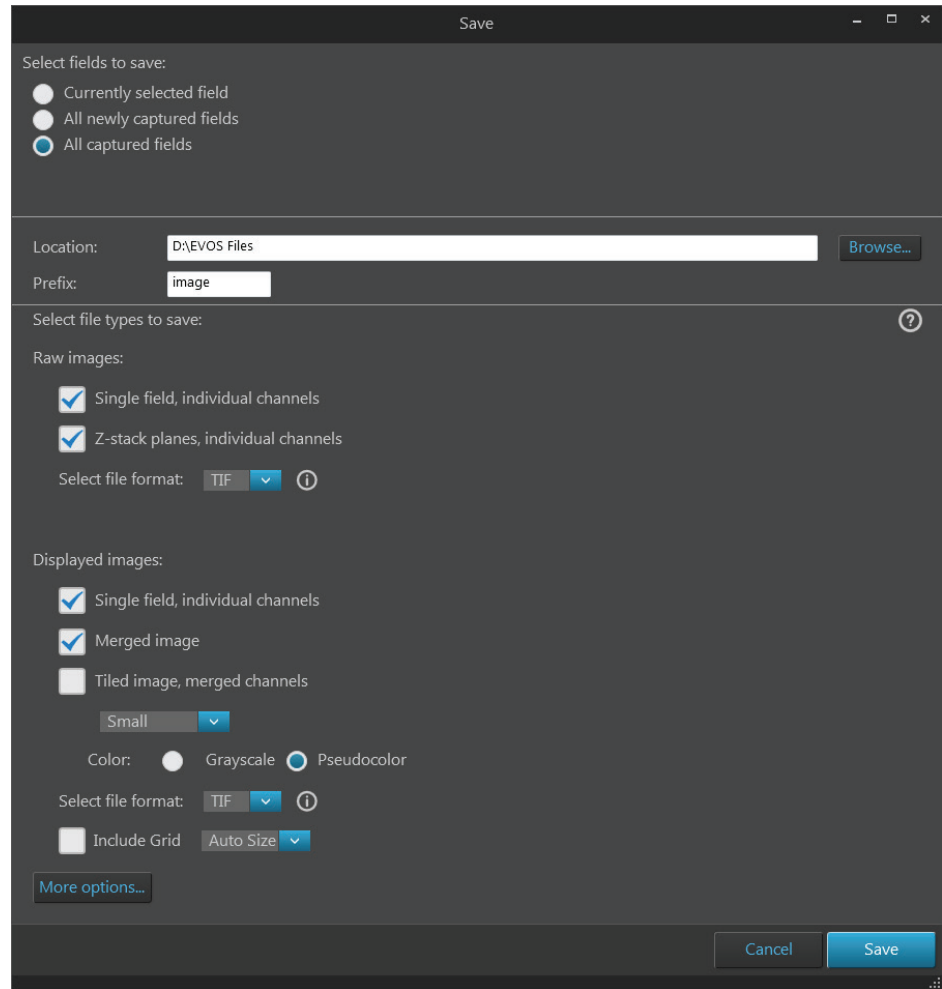

2. Select the captured fields you want save. Available options are:
  - **Currently selected field:** Saves images only from the currently selected field.
  - **All newly captured fields:** Saves images that have been captured and stored in the image cache, but not yet saved. This option is available only if you have previously saved images from the same session.
  - **All captured fields:** Saves images from all captured fields that are held in the image cache. This is typically all the images captured in an imaging session.

---

**Note:** If the software remains open while users access the instrument back to back, there may be several sets of images stored in the image cache. To clear these images from the cache, click the trash can icon (see “Delete image options”, page 130).

Saving the same images in the cache again does **not** overwrite the existing files in the destination directory; newly saved files simply have a differentiator added to the name.

---



3. Click **Browse**, navigate to the folder in which you want to save your captured images, then click **Select**.

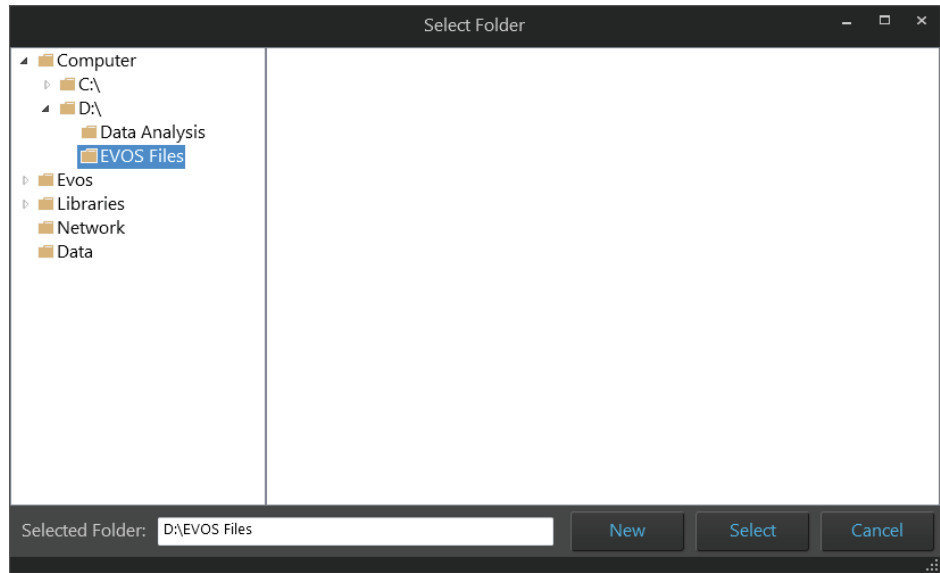

To create a new folder in which to save your captured images, navigate to the desired location, click **New**, type in the name of the newly created folder, then click **Select**.

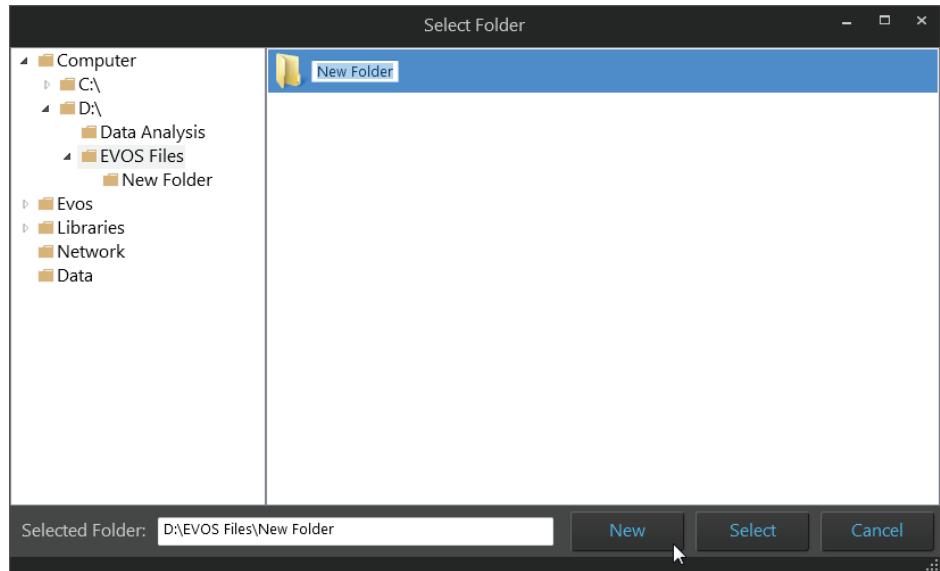

**Note:** We recommend that you save your captured images to an external hard drive.

4. If desired, type the prefix you want to use for your save images in the **File name prefix** textbox.



**Note:** For an overview of the file naming convention for saved images, see “File naming convention”, page 191.

5. Select **File types to save** by checking the corresponding checkboxes. You can choose multiple file types for your captured images.

Available options for file type are **Raw images** and **Displayed images**.

- **Raw images:** Saves images captured in different channels individually as 16-bit Raw images. Raw images contain minimally processed data from the image sensor and it is the recommended format for image analysis and quantitation.

Available **File format** for Raw image outputs are **TIFF, PNG, C01, and DIB**.

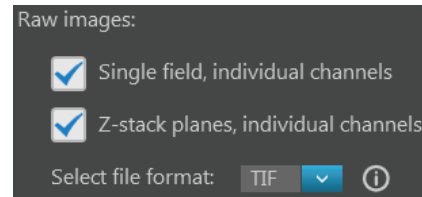

- **Displayed images:** Saves images in a format that can be viewed in most image display applications. Displayed images give the best (“prettiest”) results, especially when producing tiled and stitched images.

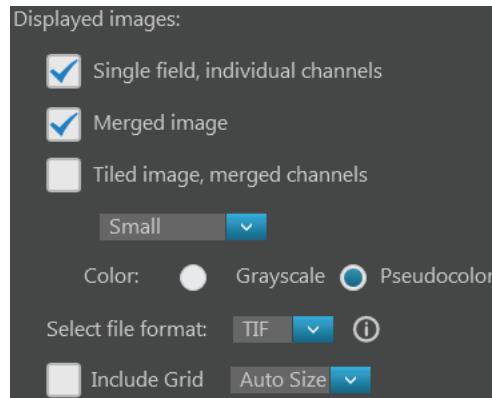

Available **Color** options for displayed images are **Grayscale** (16-bit) and **Pseudocolor** (24-bit RGB; 8-bit per RGB channel).

Available **File format** for displayed images are: **TIFF, PNG, and JPEG**.

If desired, check the **Include Grid** option and select the grid size.

---

**Note:** We recommend saving captured images in both Raw and Displayed image formats to preserve the option of using the Raw images in downstream image analysis and quantitation where 16-bit dynamic range is required, and the Displayed images for instances where “prettier” images are required. For more information on Raw and Displayed images, see “Raw vs. Displayed images”, page 125.

---

**Note:** While pseudocolors help differentiate the channels used in multi-channel overlays, grayscale images usually show more detail. 24-bit images (8-bit per RGB channel) are NOT recommended for image analysis as not all channels will display in many image analysis applications.

---

- To see more file type options in a table format, click **More options...**

Full menu of save options are displayed in a convenient table format, allowing you to save your captured images in a number of formats simultaneously.

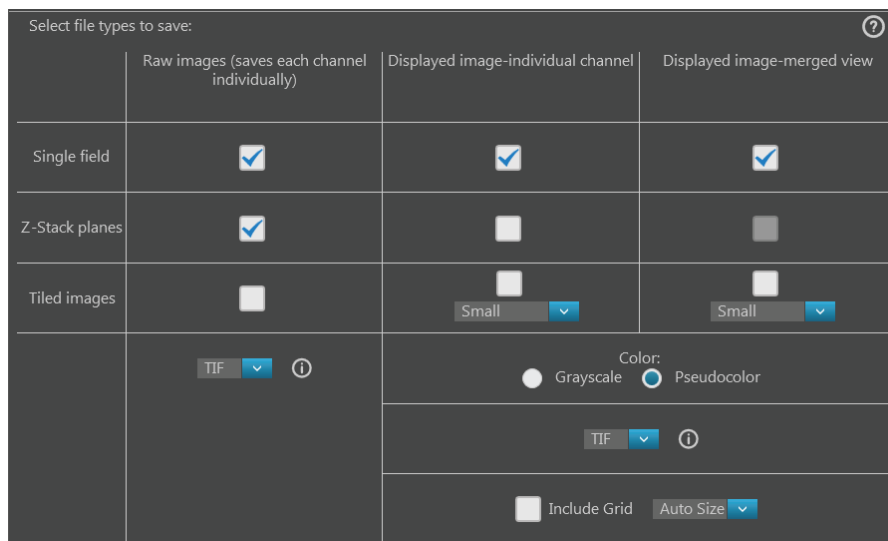

- Select the desired file types and save options by checking the corresponding checkboxes. You can select multiple file types and options.

Available file type options are **Raw images** and **Displayed images**.

- Raw images:** Saves each channel individually as 16-bit Raw images. Raw image files contain the full dynamic range and metadata needed for quantitative analysis and are the recommended format for image analysis.
  - Single field**, **Z-Stack planes**, and **Tiled images** can be saved as Raw images with each channel saved individually.
  - Available **File format** for Raw images are **TIFF**, **PNG**, **C01**, and **DIB**.
- Displayed images:** Saves each channel individually or as a merged image in a format that can be viewed in most image display applications.
  - Single field** and **Tiled images** can be saved as Displayed images from individual channels or as a merged view. However, **Z-planes** can be saved as Displayed images only from individual channels.
  - Available **Color** options for displayed images are **Grayscale** (16-bit) or **Pseudocolor** (24-bit RGB; 8-bit per RGB channel).
  - Available **File format** for displayed images are **TIFF**, **PNG**, and **JPEG**.

- After you selected save options for your captured images, click **Save**.

---

**Note:** For more information on each save option available for Raw and Displayed images, see the detailed descriptions in “Appendix C: Graphical user interface” under **Capture tab ► Save** (page 154).

---

**Note:** For more information about Tiled and Merged images, see “Tiled, Stitched, and Merged images”, page 125.

---

## 4. Create and run automated scan

---

### Overview

#### Automate tab

The EVOS™ M7000 Imaging System allows you to create and recall scan protocols, which are a series of automatically executed steps to capture multiple images over an area and/or time period based on your specifications. For repeat experiments, automated scan protocols can be saved, recalled, even edited.

The scan protocols are created using the **Automate tab**, which is organized into a series of panels that contain the necessary controls that organized by functionality (i.e., Load, Hardware, Scan Area, AutoFocus and Z Stacks, Time Lapse and Incubator, Image Save Settings, Save, and Run).

You can access the **Capture**, **Review**, and **Settings** at any time by selecting the corresponding tab.

---

**Note:** For a detailed description of Automate tab controls, see “Automate tab” in “Appendix C: Graphical user interface (GUI)” (page 157).

---

#### Workflow

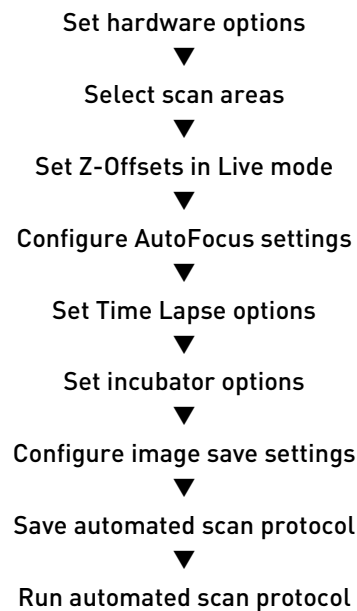

## Create a scan protocol

### Set hardware options

1. Place the vessel containing your sample on the X-Y stage using the appropriate vessel holder.  
For the types of vessel holders available for the EVOS™ M7000 Imaging System, visit [thermofisher.com/evos](http://thermofisher.com/evos) or contact Technical Support (page 247).
2. On the **Capture tab**, click the **Vessel** button, then select the sample vessel as described on page 20.

---

**Note:** If you are using the EVOS™ Onstage Incubator, set it up for operation as described in “Appendix D: EVOS™ Onstage Incubator”, page 228.

---

3. In the **Automate tab**, click **Hardware ▶ Edit** to open the Hardware panel.

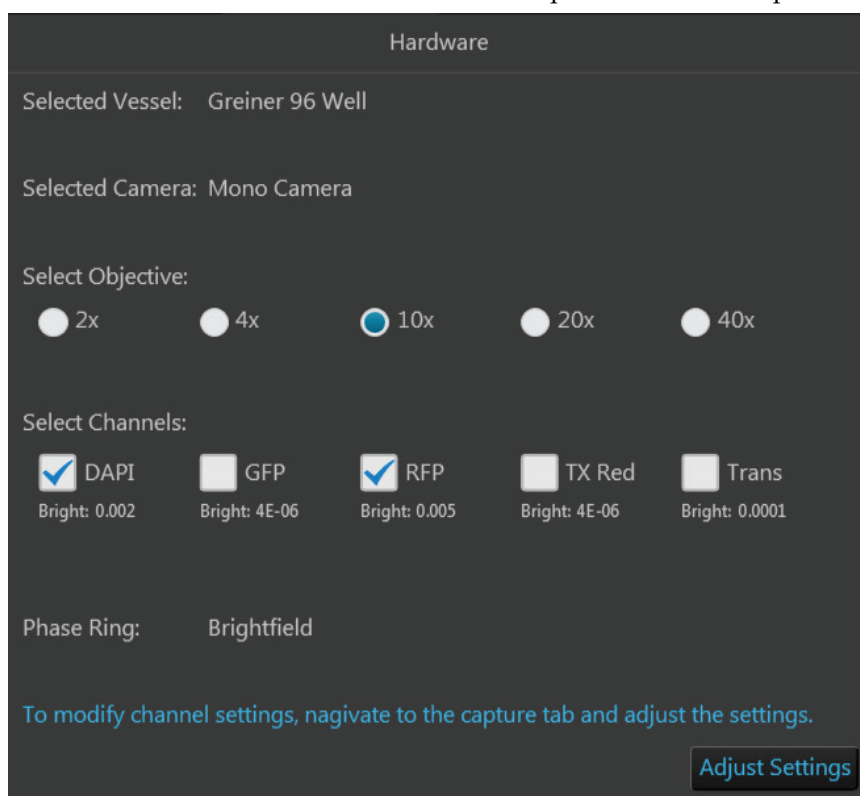

---

**Note:** For a detailed description of the controls available in the Hardware panel, see “Hardware” in “Automate tab”, page 158.

---

4. Select the **Objective** you want to use for the scan protocol. You can select only one objective at a time. In the example below, 10X objective is selected.

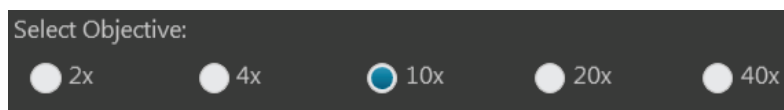

5. Select the **Channels** to capture. You can select multiple channels. In the example below, DAPI and RFP channels are selected.

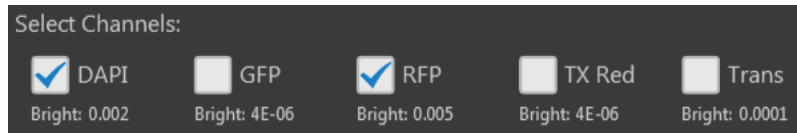

6. To modify channel settings, click **Adjust Settings** to go to the Capture tab.
7. Click **Brightness and camera settings** button to configure the **Mode**, **Camera**, and **Phase** options as described in “Set brightness and camera options”, page 21.

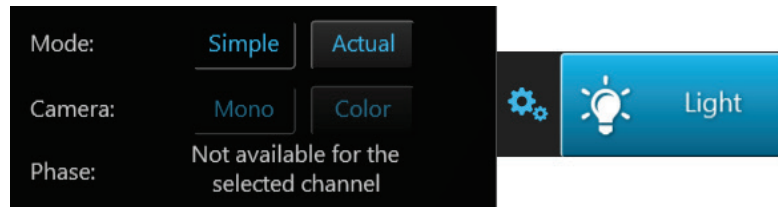

8. Click the **Light** button to turn on the excitation light for the currently selected channel (i.e., Light source) and enter the Live mode.
9. While in the Live mode, adjust the brightness settings using the **Brightness** controls as described in “Adjust brightness”, page 22.
10. If in **Simple mode**, adjust the brightness by moving the **Brightness** slider.

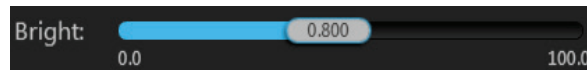

If in **Actual mode**, adjust the brightness parameters individually by moving the **Light** (LED intensity), **Exposure**, and **Gain** sliders.

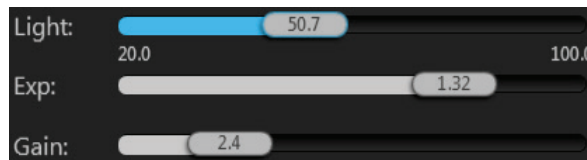

11. While still in the Live mode, select each of the remaining channels that will be used for the automated scan and adjust the brightness settings.
12. When finished with the channel settings, click the **Automate** tab to return to the Hardware panel.
13. Click **Done** to save hardware options, then proceed to “Select scan areas”, page 47.

Select scan areas

1. In the **Automate tab** ► **Scan Area**, click the **Edit** button to open the Scan Area panel. In this panel you can define the areas and fields you want to scan and specify the order in which they are captured.

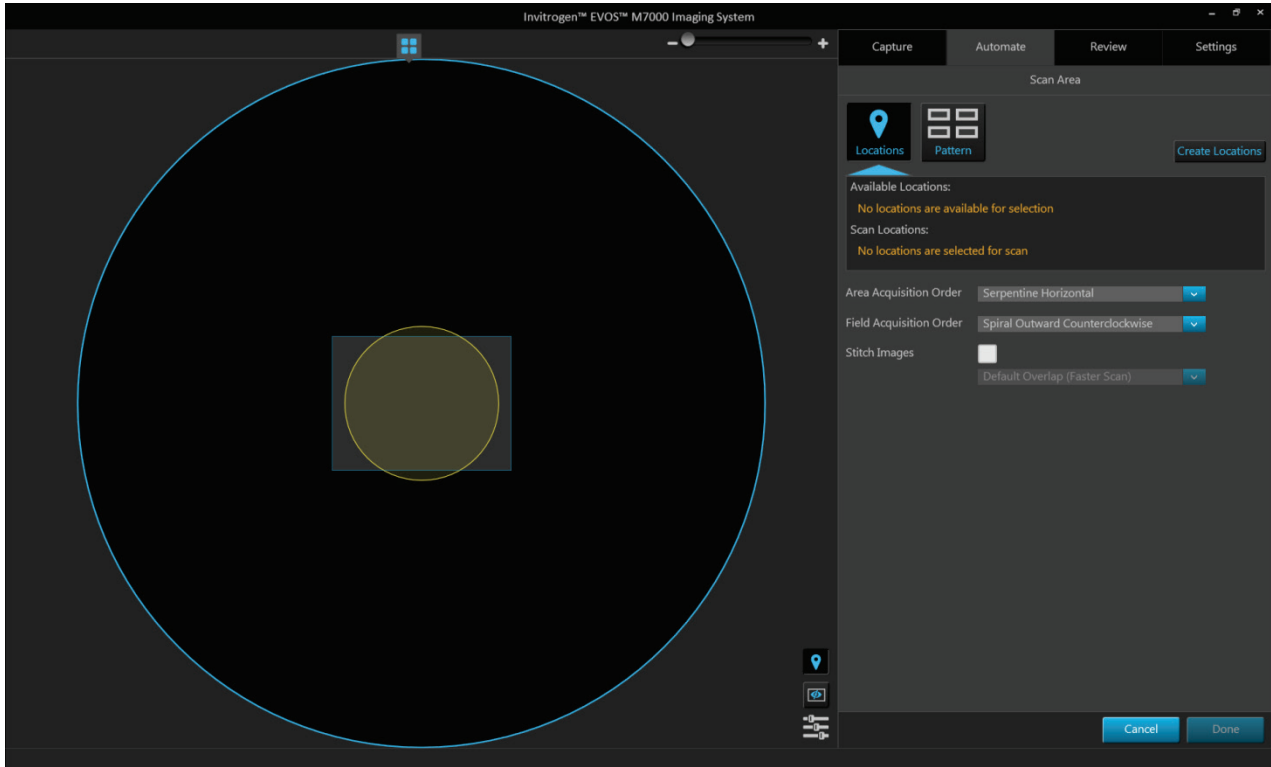

**Note:** For a detailed description of the controls available in the Scan Area panel, see “Scan Area” in “Automate tab”, page 159.

To define the areas and fields you want to scan, you have two options:

- **Scan Locations** tool (page 161) allows you to manually assign scan regions using the **Locations** tools (page 134).

To use the Scan Locations tool to select regions for automated scan, go to Step 2 (page 48).

- **Scan Pattern** tool (page 166) allows you to define the capture regions for the scan protocol as a pattern based on defined parameters.

To use the Scan Pattern tool to select regions for automated scan, go to Step 8 (page 51).

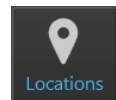

2. Click the **Locations** button to open the **Scan Locations** tool.

- If there are no previously defined locations, the Available Locations table displays the message “No locations are available for selection”.

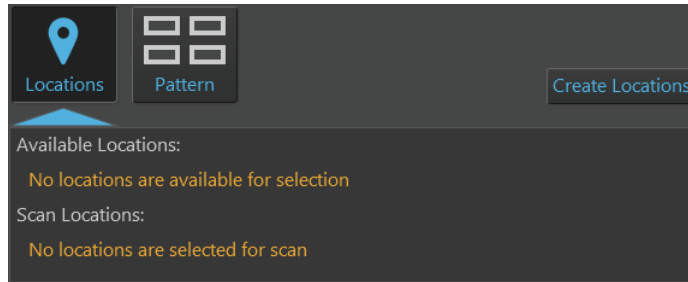
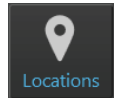

- If you have already defined locations using the **Locations** tools, they will be listed in the Available Locations table.

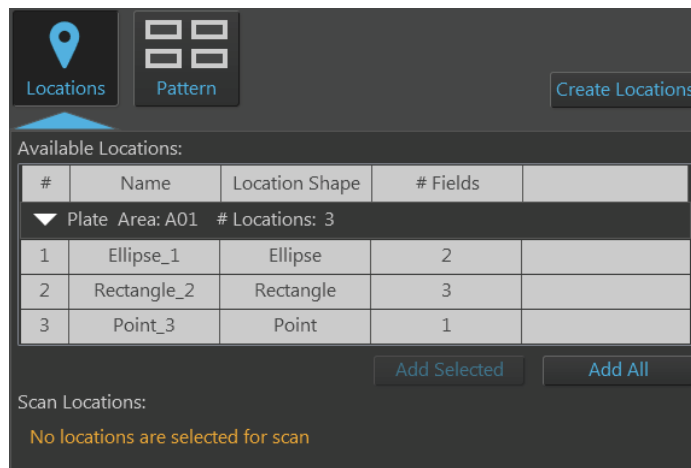

3. To create new locations for the scan protocol, click **Create Locations** to open the **Locations** tools (page 134).

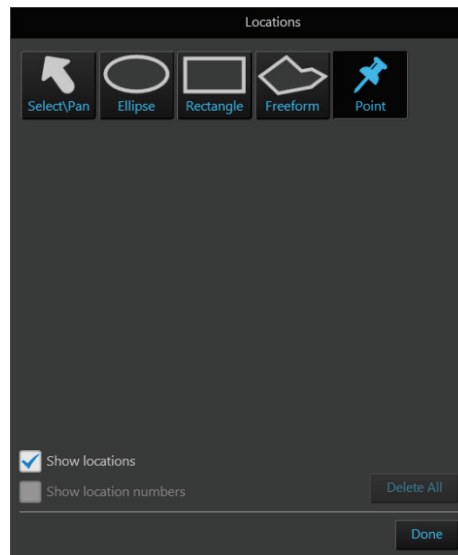

Locations – Area View

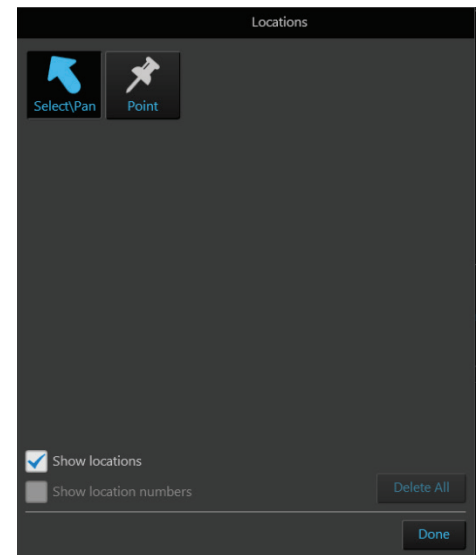

Locations – Field View



- Using the Locations tool, define the locations as described (page 135), then navigate back to the **Automate tab ▶ Scan Locations**. Newly created locations are listed in the Available Locations table.

Available Locations:

#	Name	Location Shape	# Fields	Z Position
▼ Plate Area: A01 # Locations: 3				
1	Ellipse_1	Ellipse	1	Updated
2	Rectangle_2	Rectangle	1	Initial
3	Point_3	Point	1	Updated

Scan Locations:  
No locations are selected for scan

In the following example, the first location in the list (an ellipse) is selected. The Viewing are displays the selected location and the field group that best fits the shape of the location.

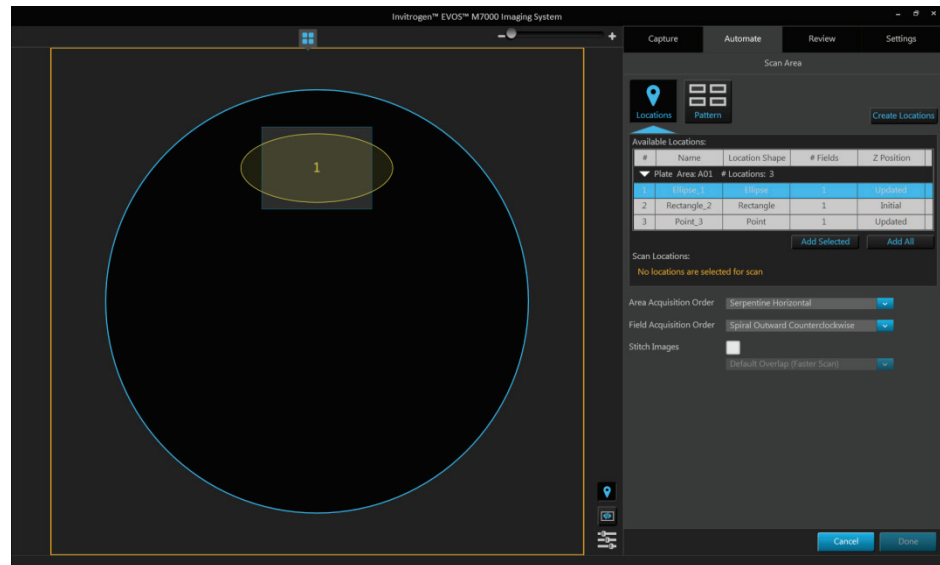

- To add a location to the scan protocol, click the desired location in the Available Locations table to select, then click **Add Selected**.

To add multiple locations to the scan protocol simultaneously, Shift-click the desired locations in the Available Locations table to select them, then click **Add Selected**.

To add all the locations listed in the Available Locations table, click **Add All**.

The locations added to the scan protocol are displayed in the **Scan Locations** table and removed from the Available Locations table.

Available Locations:

#	Name	Location Shape	# Fields	Z Position
▼ Plate Area: A01 # Locations: 2				
2	Rectangle_2	Rectangle	1	Initial
3	Point_3	Point	1	Updated

Scan Locations:

#	Name	Location Shape	# Fields	Z Position
▼ Plate Area: A01 # Locations: 1				
1	Ellipse_1	Ellipse	1	Updated

- To assign a scan area for the selected scan locations, click **Assign scan area** to open the **Vessel map**.

Assign scan area

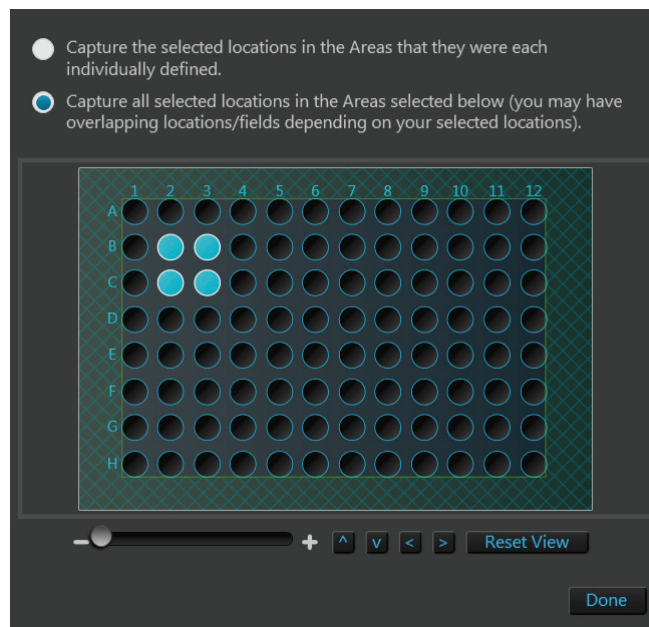
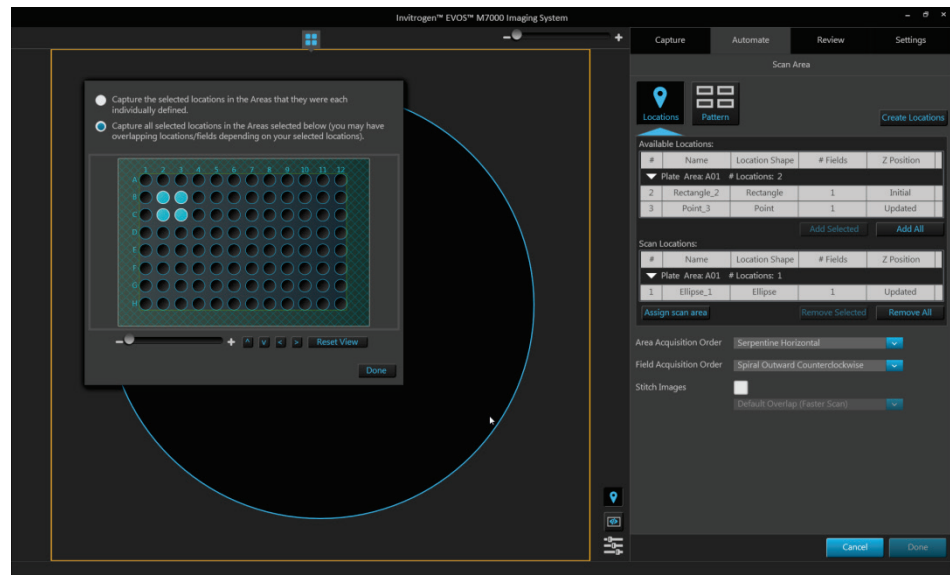

You have the option to individually define scan locations for scan area you want to capture or select the scan areas on the Vessel map to which the selected scan locations are applied.

For instructions on how to define scan areas on the Vessel map, see page 165.

- When finished, click **Done** to close the Vessel map and exit the area selection mode.

8. If you want to define the capture regions for the scan protocol as a pattern based on defined parameters, click the **Pattern** button to open the **Scan Pattern** tool.

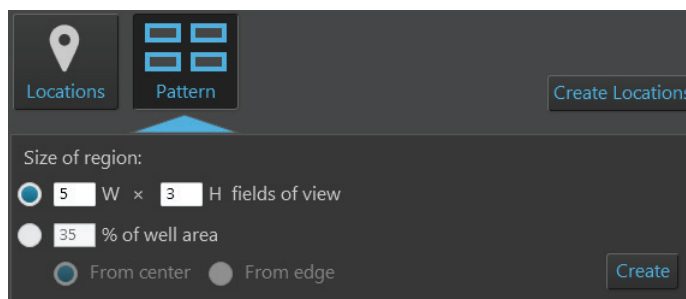

- To define the capture region as a matrix, select **W × H fields of view**, then enter the desired dimensions. You can only enter integers (page 166).
  - To define the capture region as a percentage of area covered by scan fields, select **% of well area**, enter the desired value (an integer between 1 and 100), then select **From center** or **From edge** (page 167).
9. When you are finished defining the parameters for the capture pattern, click **Create**.

---

**Note:** The region you define with the Field selection tools in Area View is replaced by a set of capture fields that best fit the drawn shape or, in the case of the Pattern tool, satisfy the criteria set for the region (see examples on pages 166–167).

In a multi-well plate, multi-chamber slide, or multi-vessel holder, the fields defined in a selected well, chamber, or vessel holder also apply to the other selected wells, chambers, or vessel holders.

---

10. If needed, click the **Delete field group** button that is displayed when you Position over the field group to delete that field group.



To delete all field groups from Area View, click the **Clear field selections** button located at the bottom right corner of Area View.



- To assign a scan area for the selected scan locations, click **Assign scan area** to open the **Vessel map**, then select the desired areas from the Vessel map (page 165).

Edit scan area

If you want to view a larger version of the Vessel map, click the **Zoom button**. Click the zoom button again closes the zoom window.

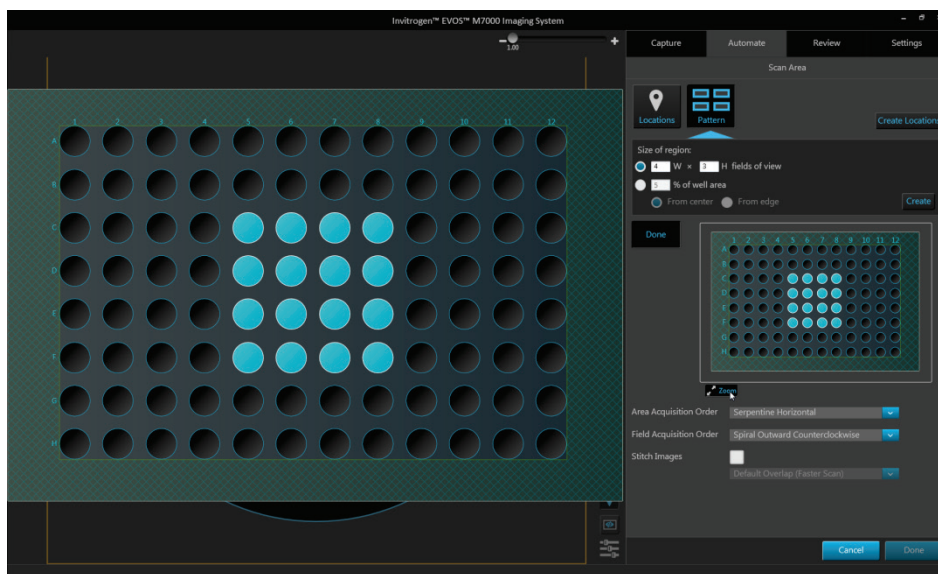

- When finished defining the scan areas, click **Done** to exit the selection mode.
- Click **Area Acquisition Order** to you specify the order in which selected areas are captured in the automated scan protocol.

Available options are:

- **Serpentine horizontal**
- **Serpentine vertical**
- **Random selection**

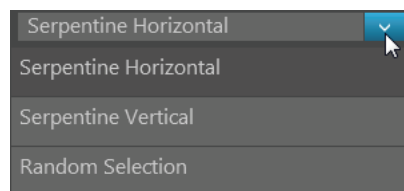

- Click **Field Acquisition Order** to you specify the order in which the fields are captured in each selected area.

Available options are:

- **Spiral Outward Counterclockwise**
- **Spiral inward Clockwise**
- **Serpentine Horizontal**
- **Serpentine Vertical**
- **Random Selection**

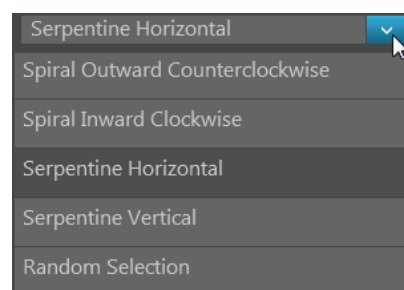

- To use stitching in your scan area, select **Stitch Images**.

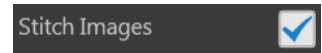

Stitching function applies an overlap when assembling captured images into a mosaic image of the scan area.

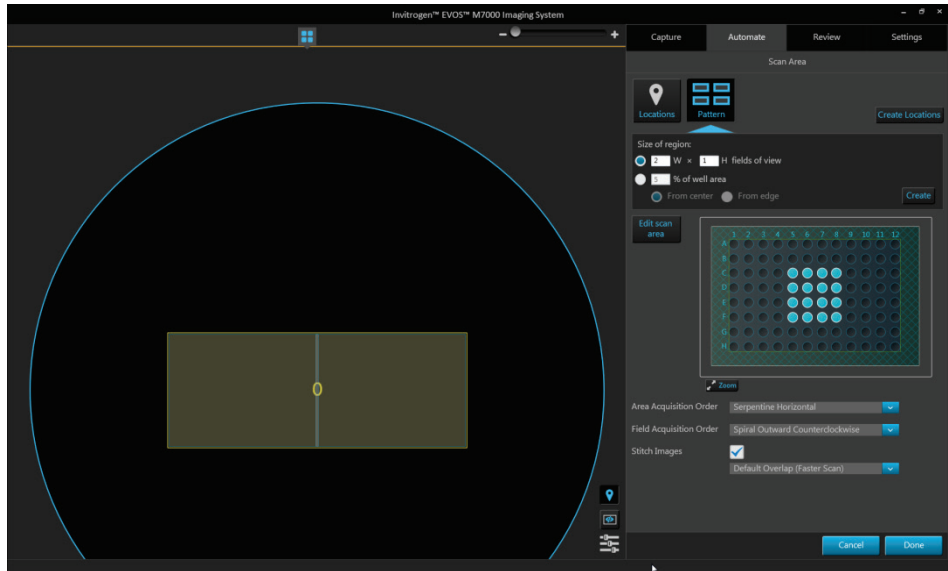

- Select **Default Overlap** for a faster scan or select **More Overlap** for a higher image quality.

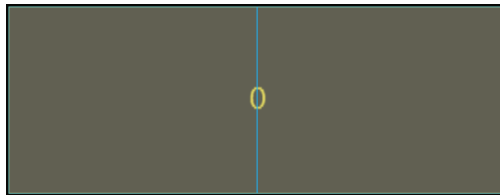
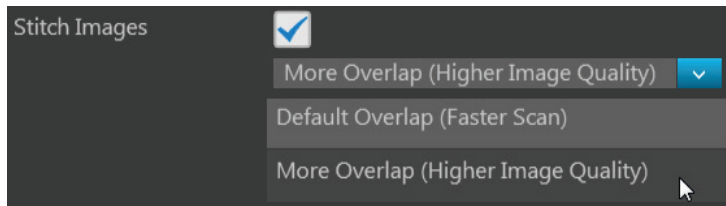

Stitching off

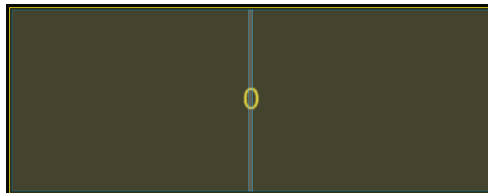

Stitching on - DefaultOverlap

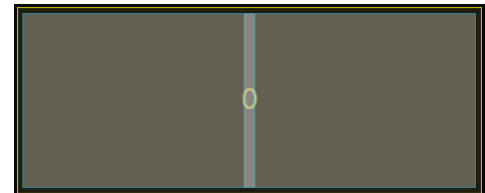

Stitching on - More Overlap

- When finished with area selection, click **Done** to save your selections and return to the Automate tab.

## Set Z-Offsets in Live mode

Z-Offsets specify the optimal focus position in each channel relative to the focus position in other channels. Setting the correct Z-Offsets is especially important when the fluorescent markers in different channels are in different focal planes.

**Note:** To learn more about locked and unlocked Z-Offset states and how to set the correct Z-Offsets, go to **Automate** tab, click the **Edit** button to open the **AutoFocus and Z-Stacks** panel, then click the **View Help Content** icon (?) to open the Help window. In the Help window, click **How do I set Z-Offsets?**

For best results, optimize the Z-Offsets in the Capture tab, and then carry the offsets over to the Automate tab.

1. In the **Automate** tab ► **AutoFocus and Z Stacks** panel, ensure that the **Capture Z-Stacks** option is unchecked, then click the **Capture** tab.

**Note:** The **Z-Offsets** option is not available as one of the Focus Position controls when the **Capture Z-Stacks** option has been selected. For more information, see “Z-Stack Settings”, page 173.

2. In the **Capture** tab, click **Advanced focus settings** and verify that the **Lock Z-Offsets** option is selected. By default, Lock Z-Offsets option is checked.

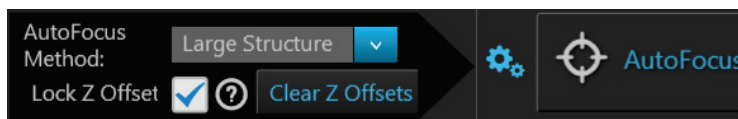

3. Select the **Objective** and **Light source** (i.e., channel) you want to capture.

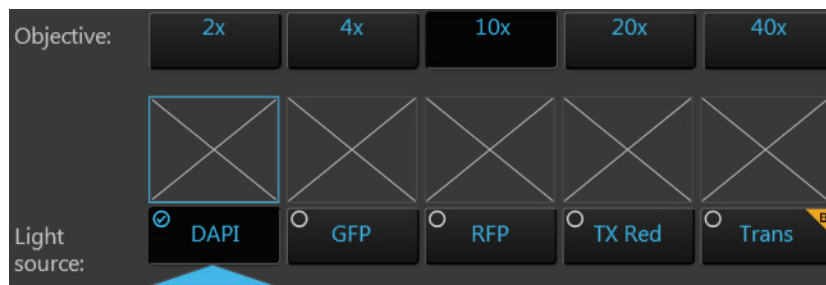

4. Click the **Light** button to enter the Live mode (page 143).

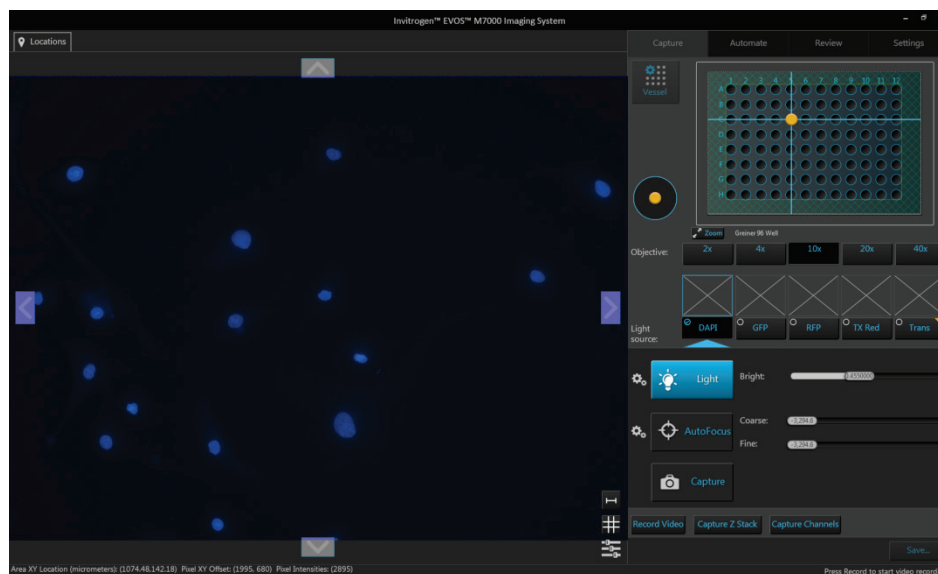

- Focus on the sample manually using the **Coarse focus** and **Fine focus** sliders or automatically by clicking **AutoFocus**.

You can also double-click on the handle of the focus slider to activate the text box and enter the desired value for the focus position.

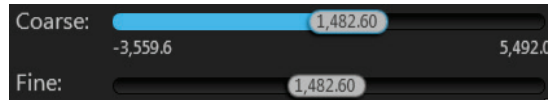

- After you have found the optimal focus position in the first channel, click **Advanced focus settings**, then uncheck the **Lock Z-Offsets** option.

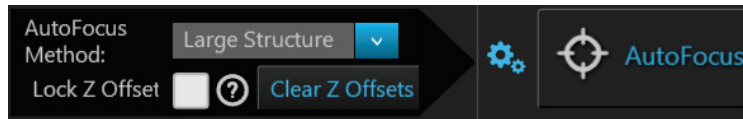

- Without changing the objective, select the next **Light source** (i.e., channel) you want to capture.
- If the light is off, click the **Light** button to enter the Live mode, then focus on the sample manually using the **Coarse focus** and **Fine focus** sliders. Alternatively, click **AutoFocus** to automatically focus on the sample.

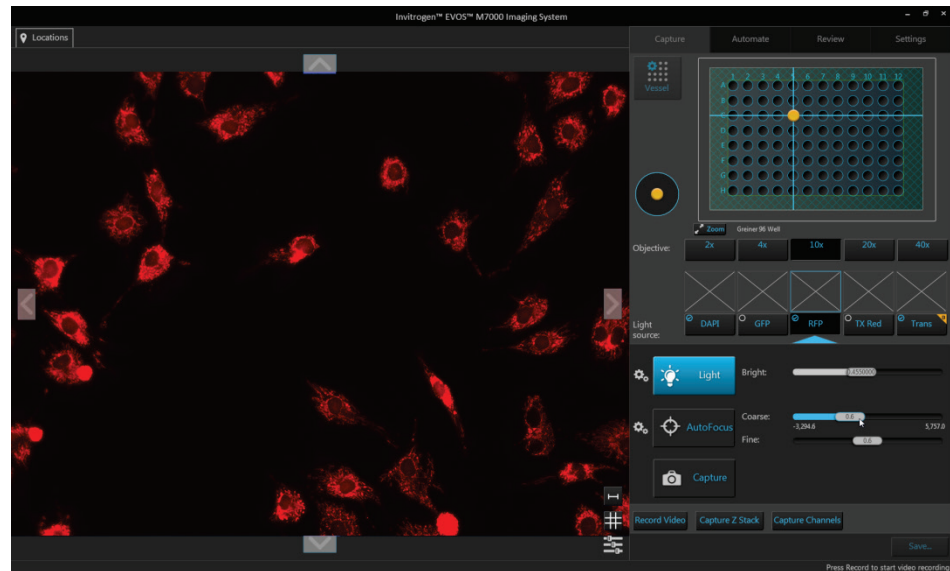

- Repeat this procedure for every channel you want to capture.
- When you have found optimal focus in all of the channels you want to capture, click the **Advanced focus settings** button, then check the **Lock Z-Offsets** option.

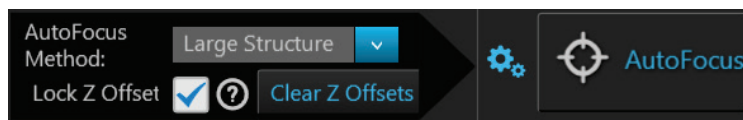

- If the light is on, click the **Light** button to turn off the Light and exit the Live mode.



12. In the **Automate tab ► AutoFocus and Z Stacks**, click the **Review** button to open the AutoFocus and Z Stacks panel.

You will see the new settings carried over to Z-Offsets under the Focus Position and the focus positions will be offset relative to each other.

In the example below, DAPI channel is focused to 118.8  $\mu\text{m}$ .

The Z-Offsets for the RFP channel relative to the DAPI channel is set to 20.05  $\mu\text{m}$ .

Therefore, the instrument will focus to 138.85  $\mu\text{m}$  ( $118.8 \mu\text{m} + 20.05 \mu\text{m}$ ) in the RFP channel.

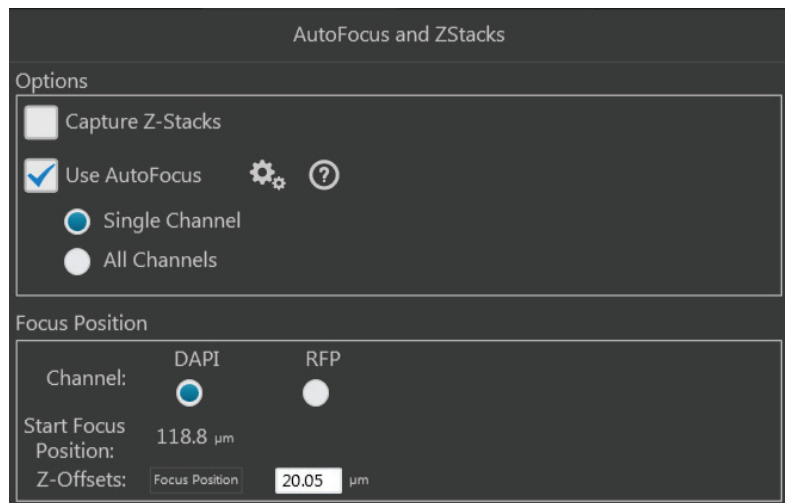

Because the Z-Offsets are preserved, selecting the RFP channel for the default focus position at 138.85  $\mu\text{m}$  refocuses the instrument to 118.8  $\mu\text{m}$  in the DAPI channel ( $138.85 \mu\text{m} - 20.05 \mu\text{m}$ ).

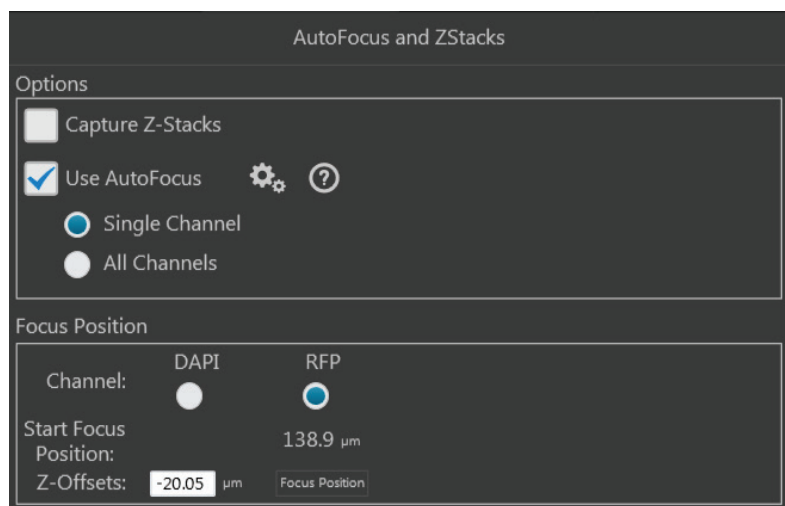

---

**Note:** If you need to adjust the Z-Offsets while in the Automate tab, make sure to close out the Autofocus and Z Stacks panel by clicking the **Done** button before navigating back to the Capture tab to make the adjustments.

---



## Configure AutoFocus settings

1. In the **Automate tab ► AutoFocus and Z Stacks**, click the **Edit** button to open the AutoFocus and Z Stacks panel. Note that if you have previously adjusted any settings in the AutoFocus and Z Stacks panel, the Edit button will have changed to Review button.

**Note:** The options available on the AutoFocus and Z Stacks panel are contextual; the controls that are displayed depend on the selections made in this panel or elsewhere in the Automate tab. For more information, see “AutoFocus and Z Stacks” in “Automate tab”, page 172.

2. Check the **Use AutoFocus** box. The panel reveals the controls to configure the autofocus settings.

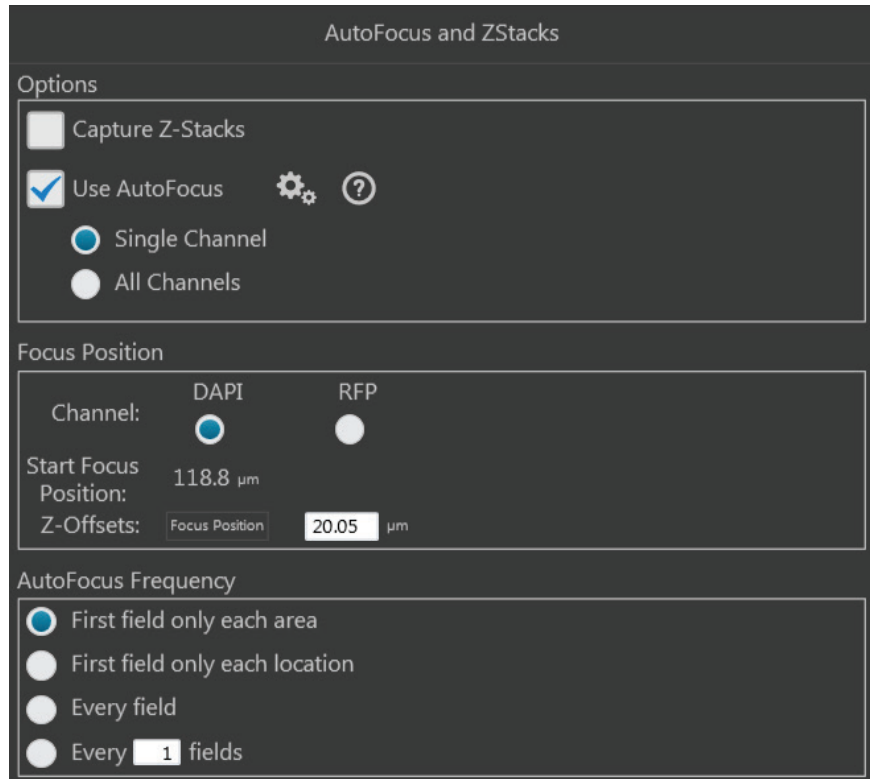
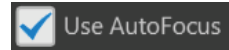

3. Select **Single Channel** or **All Channels** to autofocus during the scan protocol.

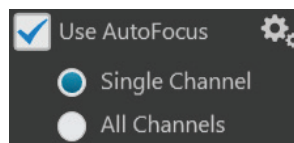

- **Single Channel:** Autofocus procedure is run in a single channel and applied to all other selected channels. This option preserves the Z-Offsets between the channels (if they were set previously).
- **All Channels:** Autofocus procedure is run separately in all selected channels. This option does not preserve the Z-Offsets between channels.

- If you have selected **Single Channel**, choose the **Channel** for which to use autofocus. The focal plane identified in this channel is used for all other channels. Note that only the channels selected in the Hardware panel (page 46) are available to choose.

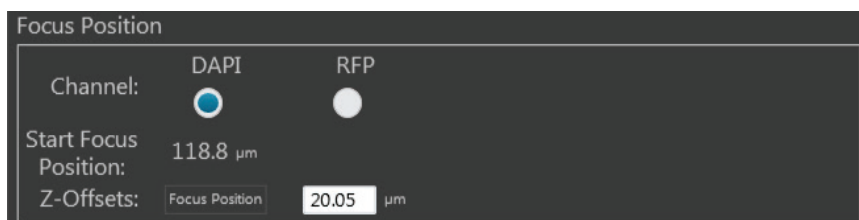

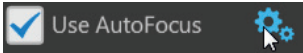
- Click the **Advanced AutoFocus Configuration** button to reveal the options for autofocus methods. 
- Select the desired **AutoFocus Method** for each channel from the corresponding dropdown menu, then click **Close**.

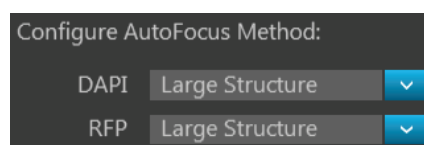

Available options are:

- **Fluorescence Optimized:** The focal plane is derived from the highest ratio between detailed, high-contrast objects against the background. Recommended for fluorescence imaging.
- **Transmitted Optimized:** The optimal focal plane is derived through statistics-based edge detection over nine different regions to determine the highest ratio of edge-to-background. Recommended for transmitted-light imaging.
- **Small Structure:** Choose for samples with many fine, hair-like structures (e.g., filaments or structural stains). This method computes the energy according to the size of image features and detects the presence or absence of small size image features.
- **Large Structure:** Choose for samples with large structures (e.g., whole cell stains). This method looks for large changes in image content as parts of the image go in and out of focus.
- **Small Bright Objects:** Choose for samples with localized staining (e.g., nuclei). This method looks for brightness changes in the center of the cell and optimizes the focus on cells that have a bright center with a dark surround.

---

**Note:** The effectiveness of the autofocus method depends on the plate type, sample type, biomarker intensity, magnification, and channel. It may be necessary to use different autofocus methods for different channels.

---

7. Set the **AutoFocus Frequency**.

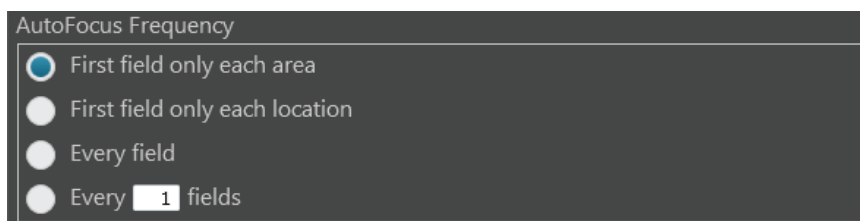

Available options are:

- **First field only each area:** Performs the autofocus operation only on the first field of each scan area. No further autofocus is performed on subsequent fields in the scan area. The focus position obtained on the first field is used for the remaining fields in the scan area.
- **First field only each location:** Performs the autofocus operation only on the first field of each location in every scan area. No further autofocus is performed on subsequent fields.
- **Every field:** Performs the autofocus operation on every field of the scan area.
- **Every <X> fields:** Allows you to specify the distance between fields in each scan area before the autofocus is triggered.

The distance between fields is expressed as “unit fields” (equivalent to a field of view as determined by the objective used); it is not determined by the order in which the fields are collected.

For example, if you want to autofocus every 3 fields, autofocus will only occur when the stage is three fields away from another autofocused field. If the stage is less than three fields away, autofocus will not occur.

---

**Note:** For a single culture dish or flask, the scan area corresponds to the entire dish or flask. For a multi-well plate or a multi-chamber slide, each scan area corresponds to a single well or chamber.

Specifying fewer fields per area to autofocus reduces the overall scan times. Frequent autofocusing may not be necessary for fields that are close together or for samples with consistent z-locations on very flat vessel surfaces.

---

8. When finished with your selections, click **Done** to return to the Automate tab and proceed to “Set Time Lapse options”, page 60.

---

**Note:** To learn more about the autofocus strategy, go to **Automate tab**, click the **Edit** button to open the **AutoFocus and Z-Stacks** panel, then click the **View Help Content** icon  to open the Help window. In the Help window, click **How do I set Software Autofocus?**

---

## Set Time Lapse options

A time lapse routine automatically captures individual images of the fields that were defined in the Scan Area at given intervals over a time period based on your specifications. The images can then be stitched together into a video.

**Note:** The capture parameters defined in the Automate tab (z-stacks, exposures, channels, etc.) are applied to every time point of a time lapse routine.

1. In the **Automate tab ▶ Time Lapse and Incubator**, click the **Edit** button to open the Time Lapse and Incubator panel, then select **Use Time Lapse**.



The time lapse controls in the panel become active.

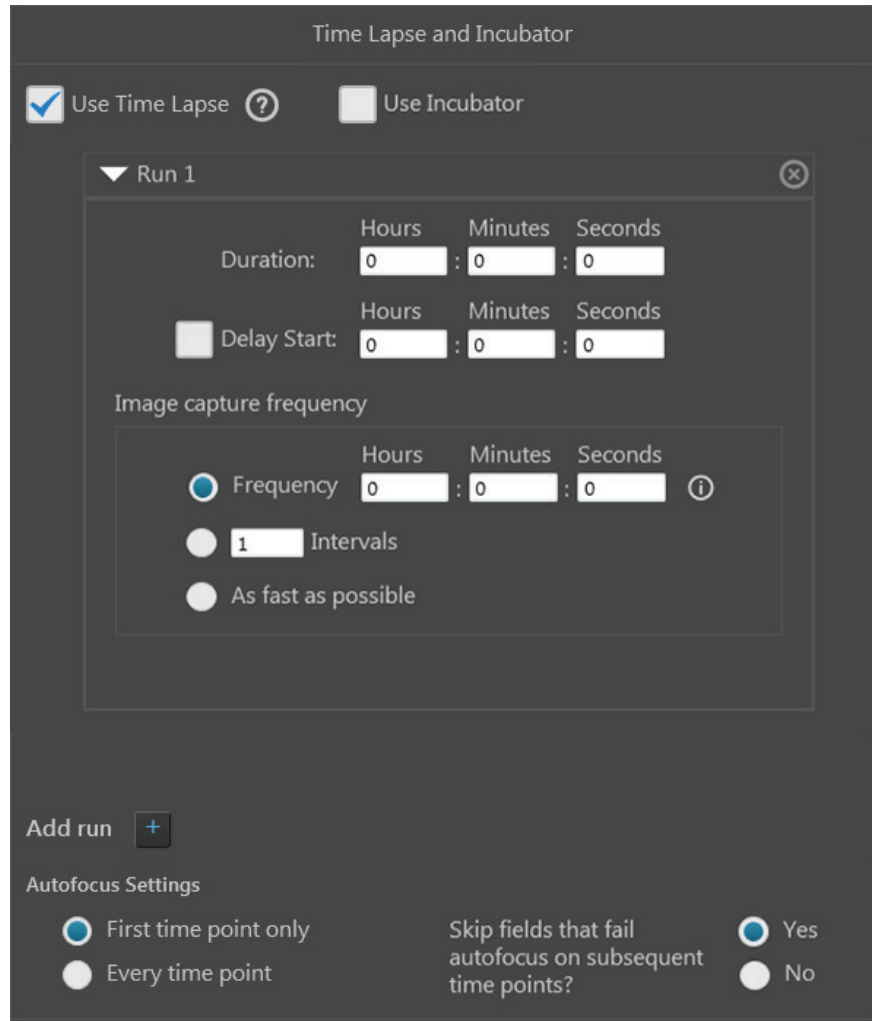

2. Enter the **Duration** of the run into the corresponding **Hours**, **Minutes**, and **Seconds** fields.

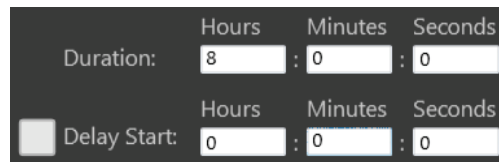

3. *Optional:* Under Run 1, select **Delay Start**, then enter the desired time interval into the corresponding **Hours**, **Minutes**, and **Seconds** fields.

The delay start determines the time interval after the start of the scan protocol in which no images are captured.

The screenshot shows two rows of time input fields. The first row is labeled 'Duration:' and has three input boxes for 'Hours' (containing '8'), 'Minutes' (containing '0'), and 'Seconds' (containing '0'). The second row is labeled 'Delay Start:' with a checked checkbox to its left, and also has three input boxes for 'Hours' (containing '0'), 'Minutes' (containing '30'), and 'Seconds' (containing '0').

4. Set the Image capture frequency.

The screenshot shows a dialog box titled 'Image capture frequency'. It has three radio button options: 'Frequency' (which is selected), '96 Intervals', and 'As fast as possible'. The 'Frequency' option has three input boxes for 'Hours' (containing '0'), 'Minutes' (containing '5'), and 'Seconds' (containing '0'). There is an information icon (i) to the right of the input boxes.

Available options are:

- **Frequency:** Enter the time period in **Hours**, **Minutes**, and **Seconds** that must elapse before a new set of images are captured.  
For example, in an experiment with an image capture frequency of 2 minutes and 30 seconds, the images will be captured every 2 minutes and 30 seconds after the initial set of images are acquired at time point 0.
- **Intervals:** Enter the total number of **time intervals** between the captured image sets for a given run duration.  
Note that the images are collected at the end of an interval. For example, in an experiment with a duration of 5 minutes and 2 intervals, the images will be captured every 2 minutes and 30 seconds after the initial set of images are acquired at time point 0.
- **As fast as possible:** Select this option to capture a new set of images immediately after completing the previous set in the order specified without any delay between the sets.  
Note that the speed with which the images are captured depends on your specifications for the scan protocol such as the autofocus frequency and exposure settings.

5. *Optional:* Click **Add run** to add another run with its own parameters (delay start, duration, image capture frequency, incubator settings) to the time lapse routine.

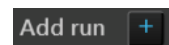



---

**Note:** The runs are performed in chronological order, beginning with Run 1 and ending with Run N. You can remove a run from the time lapse routine by clicking the corresponding **Delete Run** button  (page 184).

---

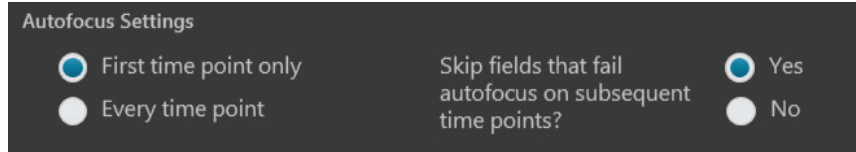
6. Set the **Autofocus Settings** for the time lapse routine.



Available options are:

- **First time point only:** Select this option if you want to autofocus at the selected locations only at the first time point of the time lapse routine.
  - **Every time point:** Select this option if you want to autofocus at the selected locations at every time point of the time lapse routine.
  - **Autofocus fail options:** Click **Yes** to skip an autofocus location at subsequent time points in the event of an autofocus failure at that location. Click **No** to attempt autofocus at each selected autofocus location regardless of previous success or failure.
7. If you want to use the EVOS™ Onstage Incubator during your time lapse routine, see “Set incubator options”, page 63.

Otherwise, click **Done** to return to the Automate tab and proceed to “Configure image save settings”, page 64.

## Set incubator options

**IMPORTANT!** Before using the EVOS™ Onstage Incubator in your time lapse experiments, make sure that:

- The EVOS™ Onstage Incubator has been set up for use (see “Set up the EVOS™ Onstage Incubator”, page 228).
- The gas inputs have been configured (see “Configure gas inputs”, page 234).
- The oxygen sensor has been calibrated (see “Calibrate oxygen sensor”, page 235).

1. In the **Automate ▶ Time Lapse** panel, select **Use Incubator**.



The Incubator controls in the panel become active.

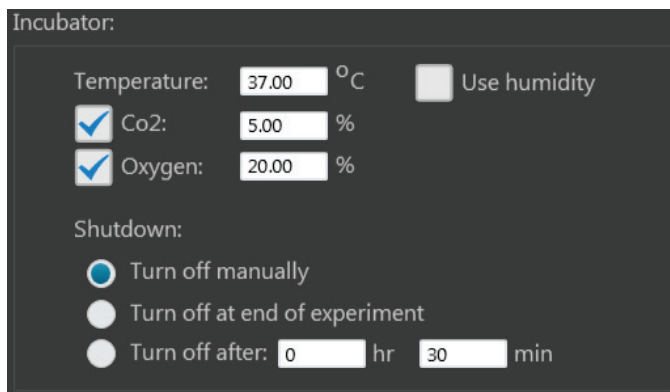

**Note:** Use **Time Lapse** option must be previously checked for the **Use Incubator** option to be available.

2. Enter the target values for **Temperature**, **CO<sub>2</sub>**, and **Oxygen**.

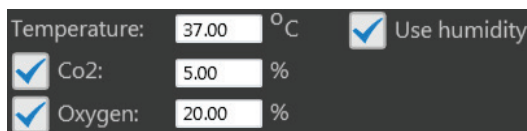

3. If desired, select **Use humidity**.
4. Select the desired **Shutdown** option for the incubator.

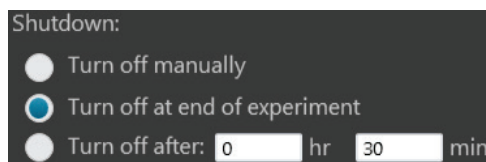

Available options are:

- **Turn off manually:** The incubator remains on until the **Use Incubator** option is manually deselected.
  - **Turn off at the end of experiment:** Heat, humidity, and the flow of gas are automatically turned off at the end of the experiment.
  - **Turn off after:** Enter the time period in **hours** and **minutes** that must elapse before the heat, humidity, and the flow of gas are automatically turned off.
5. When finished with your selections, click **Done** to return to the Automate tab and proceed to “Configure image save settings”, page 64.

## Configure image save settings

1. In the **Automate tab ► Image Save Settings**, click the **Edit** button to open the Image Save Settings panel.

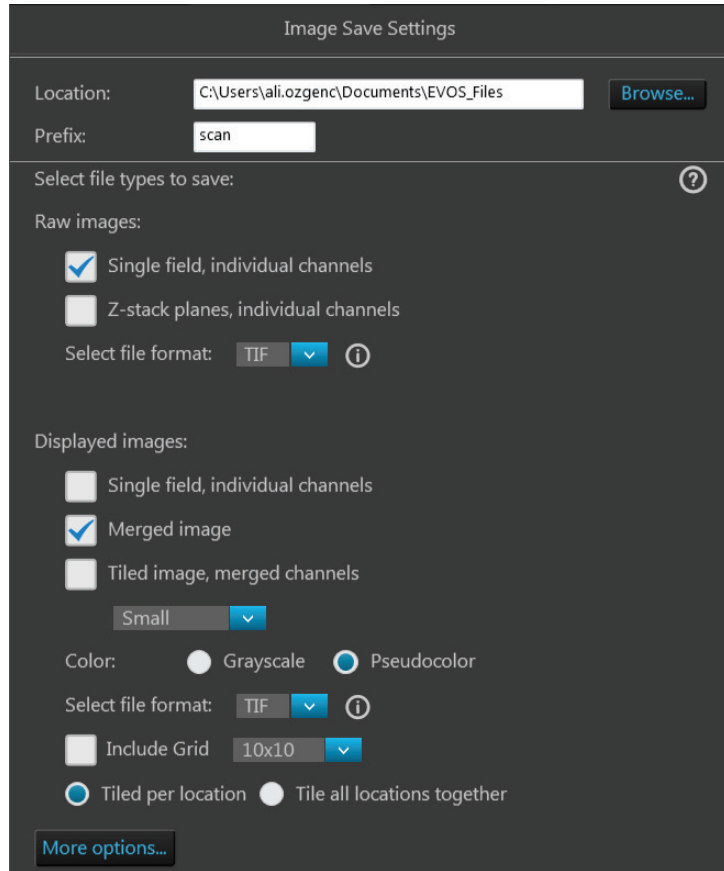

2. Click **Browse**, navigate to the folder in which you want to save your images captured during the automated scan protocol, then click **Select**.

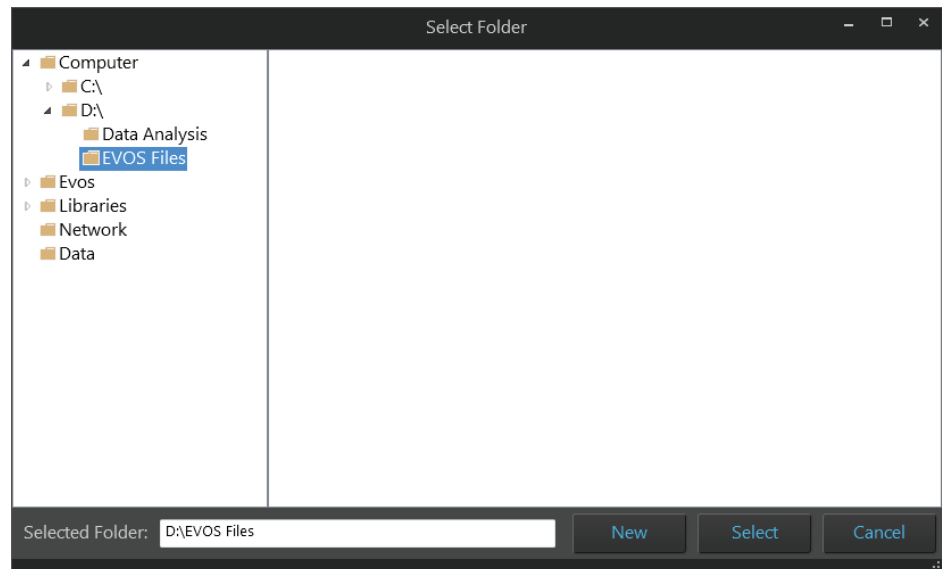

**Note:** We recommend that you save your captured images to an external hard drive.



- To create a new folder for the scan protocol, navigate to the desired location, click **New**, type in the name of the newly created folder, then click **Select**.

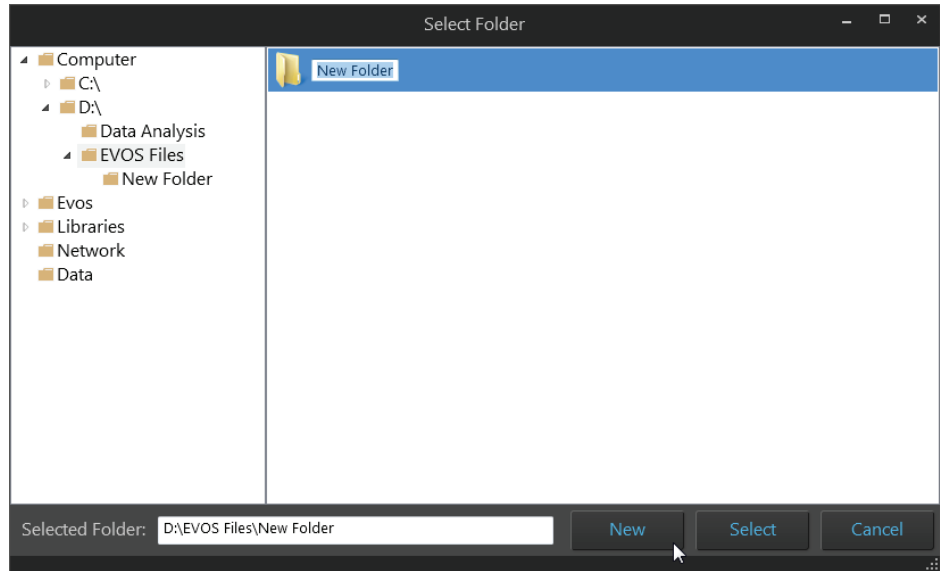

- If desired, type the prefix you want to use for your saved images in the **Prefix** textbox.

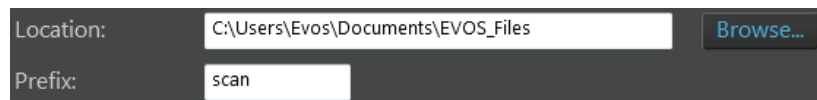

---

**Note:** For file naming conventions for saved images, see “File naming convention”, page 191.

---

- Select **File types to save** by checking the corresponding checkboxes. You can choose multiple file types for your images captured during the automated scan protocol.

Available file type options are **Raw images** and **Displayed images**.

- Raw images:** Saves images captured in different channels individually as 16-bit Raw images. Raw images contain minimally processed data from the image sensor and it is the recommended format for image analysis and quantitation.

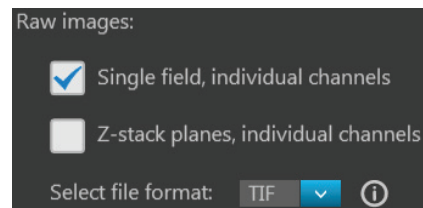

- Available **Raw image** options are:

**Single field, individual channels:** Saves images captured in each field and each channel individually.

**Z-stack planes, individual channels:** Saves the z-stack projection and each z-plane for each field and each channel as a separate image.

- Available **File format** for Raw images are **TIFF, PNG, C01, and DIB**.

- **Displayed images:** Saves images in a format that can be viewed in most image display applications. Displayed images give the best (“prettiest”) results, especially when producing tiled and stitched images

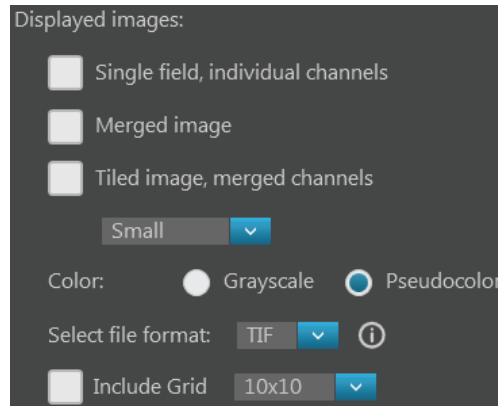

- Available **Displayed image** options are:
  - Single field, individual channels:** Saves images captured in each field and each channel individually.
  - Merged image:** Saves the images of a field captured in different channels as a multi-channel overlay.
  - Tiled image, merged channels:** Merges the images captured in each channel, then aligns them close together into a tiled format.

You can create tiled images with one of the following dimensions: **Small** (2000 × 2000 pixels), **Medium** (4000 × 4000 pixels), **Large** (10,000 × 10,000 pixels), or **Maximum** (26,000 × 26,000 pixels).
- Available **Color** options for displayed images are:
  - Grayscale:** 16-bit.
  - Pseudocolor:** 24-bit RGB (8-bit per RGB channel).
- Available **File format** for Displayed images are: **TIFF**, **PNG**, and **JPEG**.

---

**Note:** We recommend saving captured images as both Raw and Displayed images to preserve the option of using the Raw images in downstream image analysis and quantitation, and the Displayed images for instances where “prettier” images are required. For more information on Raw and Displayed images, see “Raw vs. Displayed images”, page 125.

---

**Note:** For more information about when to use tiled or stitched images, see “Tiled, Stitched, and Merged images”, page 125.

---

**Note:** While pseudocolors help differentiate the channels used in multi-channel overlays, grayscale images usually show more detail. 24-bit pseudocolor images (8-bit per RGB channel) are NOT recommended for image analysis because not all channels will display in many image analysis applications.

---

6. Check the **Include Grid** option to superimpose a grid on the displayed images. You have the following options for the grid size (in pixels): **Auto**, **10 × 10**, **50 × 50**, **100 × 100**, **200 × 200**, and **500 × 500**.
7. Select **Tiled per location** or **Tile all locations together**.

8. To see more file type options in a table format, click **More options...**  
Full menu of save options is displayed in a convenient table format, allowing you to save your captured images in multiple formats simultaneously.

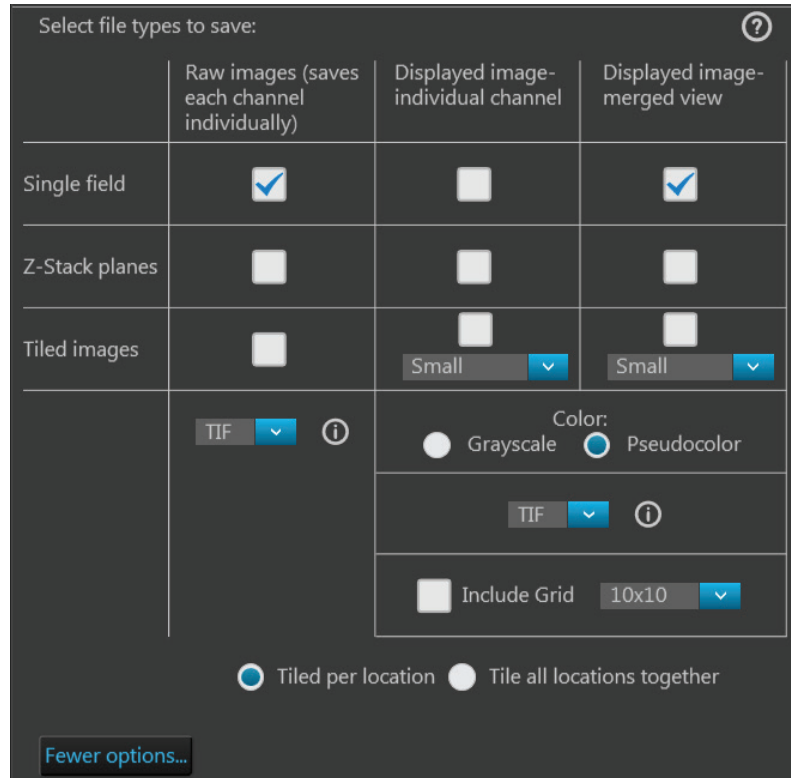

9. Select the desired file types and options by checking the corresponding checkboxes. You can select multiple file types and options.  
Available file type options are **Raw images** and **Displayed images**.
- **Raw images:** Saves each channel individually. This is the recommended format for image analysis and quantitation.
    - **Single fields, Z-planes, and Tiled images** can be saved as Raw images.
    - Available **File format** for Raw images are **TIFF, PNG, C01, and DIB**.
  - **Displayed images:** Saves each channel individually or as a merged image in a format that can be viewed in most image display applications.
    - **Single fields, Z-planes, and Tiled images** from individual channels can be saved as Displayed images.
    - However, you can only save **Single fields** and **Tiled images** as a Displayed image in merged view; **Z-planes** can only be saved from individual channels.
    - Available **Color** options for Displayed images are **Grayscale** (16-bit) or **Pseudocolor** (24-bit RGB; 8-bit per RGB channel).
    - Available **Brightness** options for Displayed images are **High** and **Full**.
    - Available **File format** for Displayed images are **TIFF, PNG, and JPEG**.
10. After you have configured Image Save Settings for your automated scan protocol, click **Done** to return to the Automate tab.

## Save automated scan protocol

When you have finished creating your automated scan protocol, the total number of images to be captured in the scan, estimated scan file size, estimated temp file size, and the drive space available for the scans are displayed above the Save and Load buttons in the Automate tab.

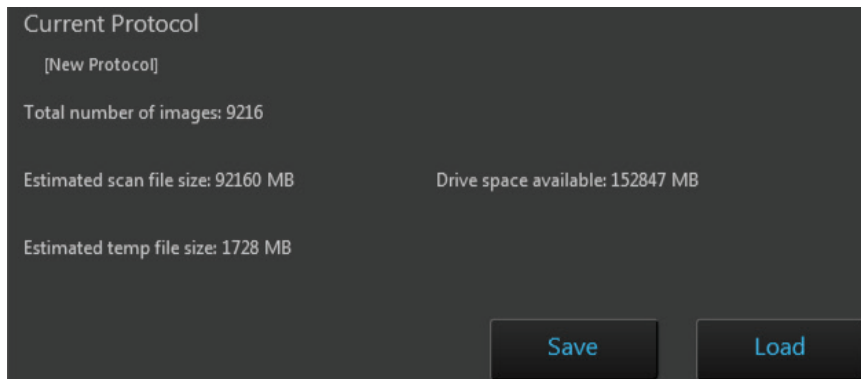

At this point, we recommend saving the automated scan protocol for future recall in repeat experiments. For convenience, you can also edit recalled scan protocols to create new routines rather than creating them from the very beginning.

1. In the **Automate** tab, click **Save** to open the Save As dialog, then navigate to the location in which you want to save your scan protocol.

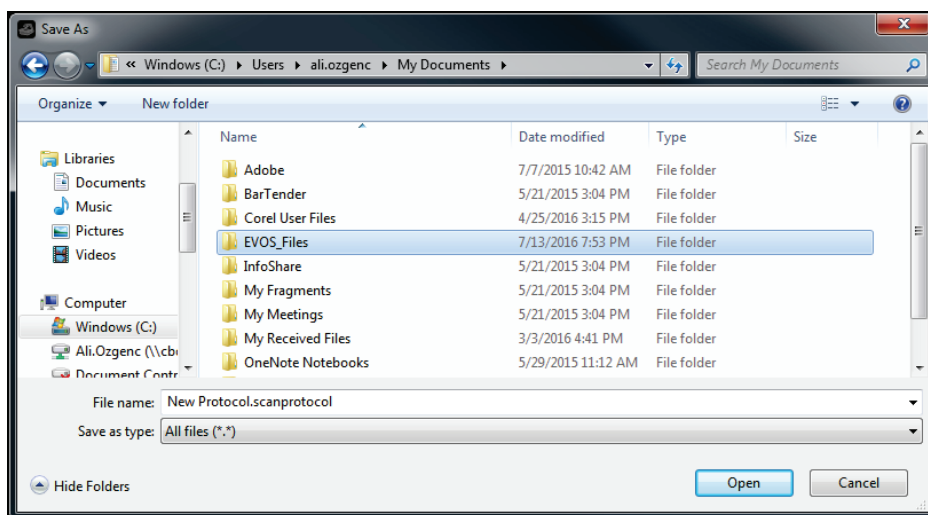

2. In the **File name** text box, type in the name of your new routine.  
The default name for new scan protocols is "New Protocol.scanprotocol".
3. Click **Save** to save your scan protocol and close the Save As dialog.
4. To run your automated scan protocol, proceed to "Run newly created scan protocol", page 69.

# Run automated scan protocol

## Run newly created scan protocol

1. In the **Automate** tab, click **Run** to run the automated scan protocol you have just created.

The EVOS™ M7000 Imaging System starts executing the steps specified in your automated scan protocol to capture multiple images over an area and/or time period.

The Viewing area displays the fields as they are being captured during the scan, while the Vessel map indicates the area being captured.

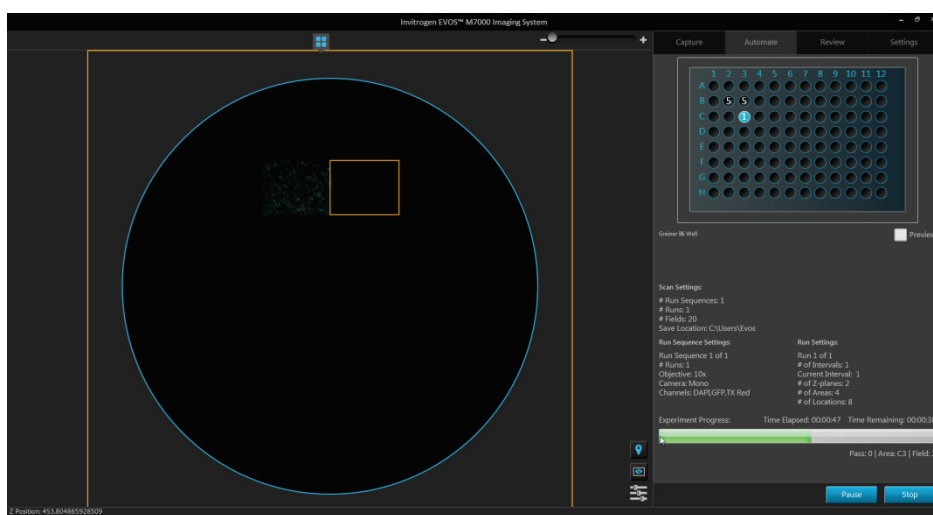

The Scan Settings, Run Sequence Settings, and Run Settings specified in your scan protocol are displayed below the Vessel map, and the Experiment Progress bar tracks the progress of the run.

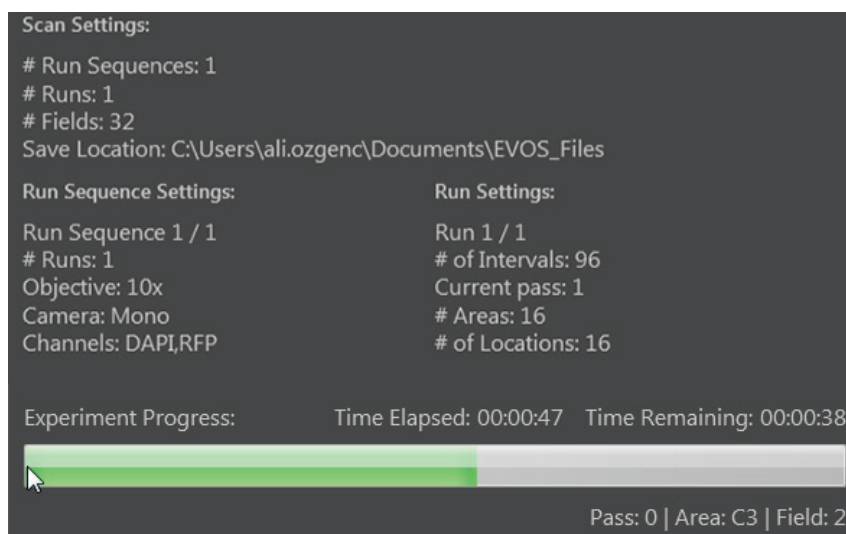

2. Click **Pause** to pause the automated scan protocol anytime during a run. Click **Resume** to restart the scan protocol from the step where it was paused.
3. If you want to abort the scan protocol before it is completed, click **Stop**. Click **Save** to save the images acquired during the aborted scan protocol in the location specified in Image Save Settings, or click **Discard** to delete them.

- When the scan protocol is completed, click **Done**.

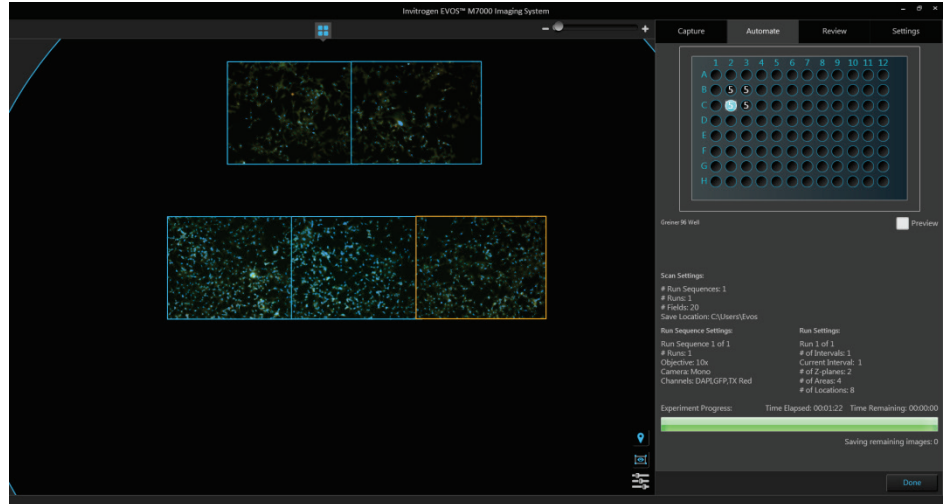

### Load and run a saved scan protocol

For repeat experiments, you can recall and run a saved scan protocol. If desired, you can also edit the settings of the recalled scan protocol.

- On the Automate tab, click **Load**, then navigate to the folder containing the saved scan protocol you want to recall.

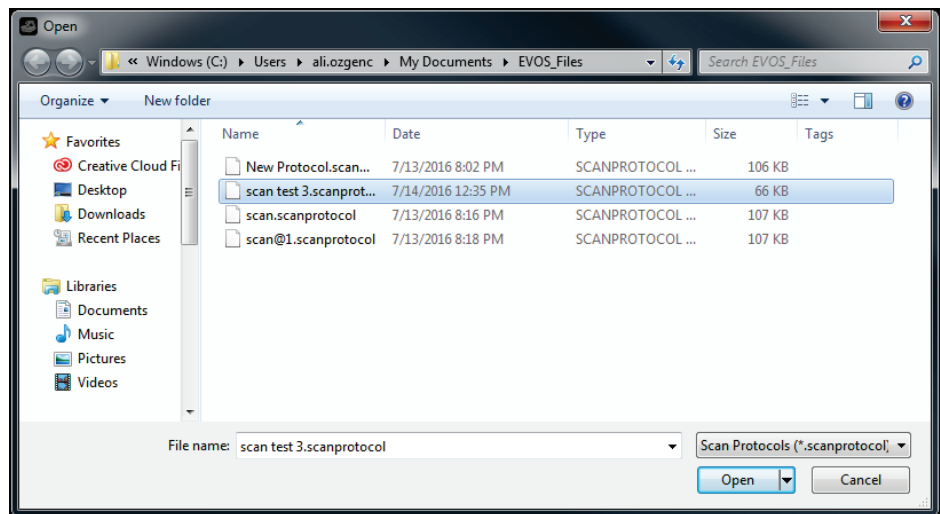

- Click the saved scan protocol of interest to select it, then click **Open**.
- If you want to edit the recalled scan protocol, click **Review** to open the Automate tab panel, adjust the settings you want to change, then click **Done** to return to the Automate tab.
- Click **Run** to run the recalled routine.
- When the scan protocol is completed, click **Done**.

---

**Note:** Saved scan protocols retain the information about the scan areas as well as the camera and lighting options set when creating the protocol. To change these settings for a new experiment, click **Review** after loading the saved scan protocol and make the desired changes.

---

## 5. Review saved images

### Review tab

The **Review tab** allows you to review saved images, including Z-Stack images and images captured during automated scans, and scan and field metadata associated with the images. It also allows you to launch the EVOS™ Analysis application to analyze and annotate saved images (see “Analyze and annotate saved images”, page 75). For the descriptions of the controls available in the Review tab, see page 192.

**Note:** For a detailed description of the Review tab controls, see “Review tab” in “Appendix C: Graphical user interface (GUI)” (page 192).

### Review saved images

1. Click the **Review** tab.
2. In the **Folders** panel, navigate to the folder containing your saved images, then click to select it. The contents of the selected folder are displayed in the Image preview/Image list area.

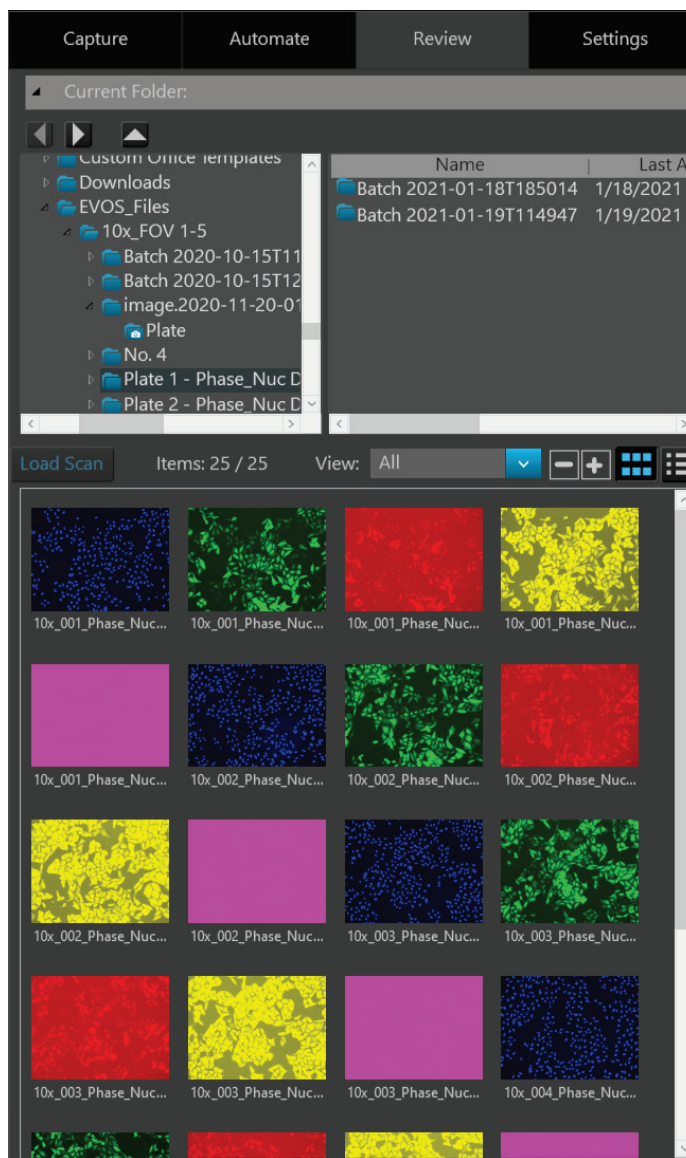



- To display the folder/image preview in list format, click the **List view** button.

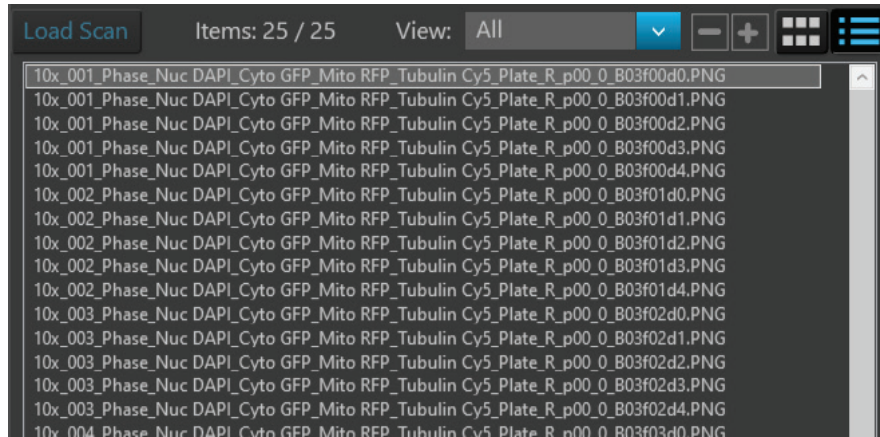

- To review an image and associated metadata, double-click the image in the Image preview/Image list area.

The selected image is displayed in the Viewing area and the Folders/Image preview panel changes to Image metadata/Browse panel.

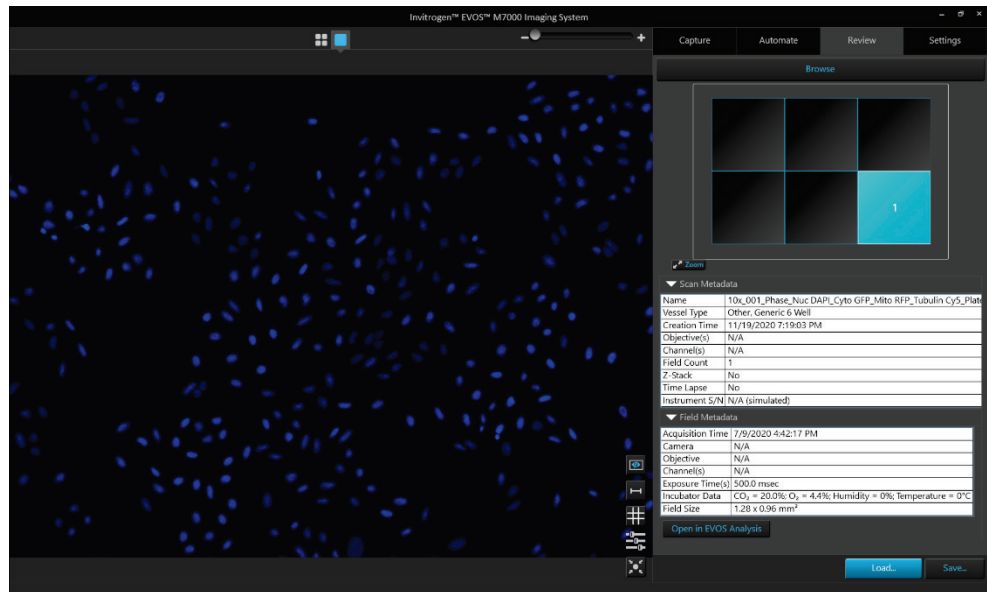



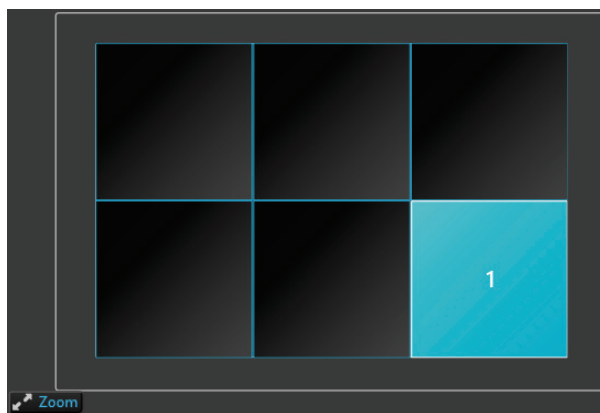



The Vessel map shows the location of the imaged field in the original sample vessel.





The **Scan Metadata** panel shows metadata about the scan and the **Field Metadata** panel shows the metadata concerning the imaged field displayed.

▼ Scan Metadata	
Name	10x_002_Phase_Nuc DAPI_Cyto GFP_Mito RFP_Tubulin Cy5_Plate
Vessel Type	Other, Generic 6 Well
Creation Time	11/19/2020 7:19:03 PM
Objective(s)	N/A
Channel(s)	N/A
Field Count	1
Z-Stack	No
Time Lapse	No
Instrument S/N	N/A (simulated)
▼ Field Metadata	
Acquisition Time	7/9/2020 4:43:47 PM
Camera	N/A
Objective	N/A
Channel(s)	N/A
Exposure Time(s)	500.0 msec
Incubator Data	CO <sub>2</sub> = 20.0%; O <sub>2</sub> = 4.3%; Humidity = 0%; Temperature = 0°C
Field Size	1.28 x 0.96 mm <sup>2</sup>

5. *Optional:* Adjust the display options as desired.
  - Click **Scale bar** to display the scale bar over the Viewing area. This option is available only in Field View. 
  - Click **Grid** to superimpose a grid over the Viewing area. This option is available only in Field View. 
  - Click **Image display settings** to adjust brightness, contrast, and gamma parameters for the displayed image. This option is available in Area and Field Views. 
  - Click **Toggle field borders** to switch the display of the borders around the captured fields on and off. This option is available only in Area View. 
  - Click **Toggle locations display** to switch the display of locations (defined with the Location tools) on and off. 
  - Click **Center on selected field** to center the Viewing area on the selected field. This option is available only in Area View. 
6. To review another image, click **Browse** or **Load**, then select another image.
7. To save the changes you have made to the image in the Review tab, click **Save**.
8. To annotate and analyze the image using the EVOS™ Analysis application, click **Open in EVOS Analysis**. 

The EVOS™ Analysis application allows annotations and measurements of your image, and provides tools for quantitative analysis (cell count, confluence, and transfection efficiency). For more information, see “Analyze and annotate saved images”, page 75.

---

**Note:** The **Open in EVOS Analysis** button becomes available in the Review tab only after you have opened the image you wish to analyze in the Viewing area.

---

9. *Optional:* To annotate and analyze the image using the Celleste™ Image Analysis Software, click **Open in Celleste**.

**Open in Celleste**

**Note:** The **Open in Celleste** button is available only if you have the Celleste™ Image Analysis Software (available separately from Thermo Fisher Scientific) installed on the computer running the EVOS™ M7000 Software. The button becomes visible in the Review tab after you have opened the image you wish to analyze.

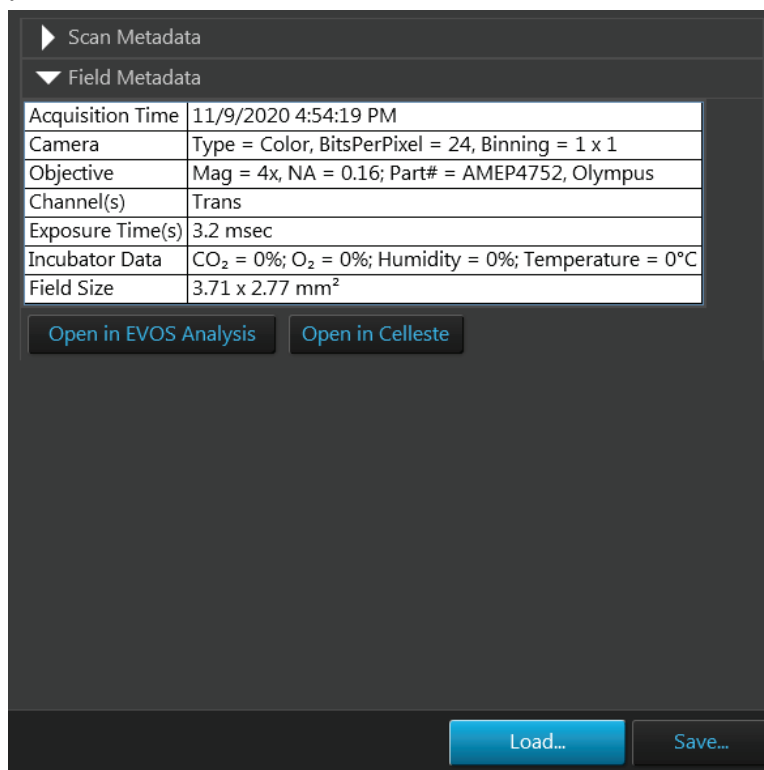

## Celleste™ Image Analysis Software

The Celleste™ Image Analysis Software (available separately from Thermo Fisher Scientific) is a full-feature image analysis suite designed for a range of biological applications, from image adjustments and processing with manual and automatic measurements over multiple channels, to segmentation and classification tools that help you transform images into quantitative data in a streamlined and customizable workflow.

For more information on the Celleste™ Image Analysis Software, go to [thermofisher.com/celleste](https://www.thermofisher.com/celleste). For instructions on how to analyze your images with the Celleste™ Image Analysis Software, refer to the Celleste™ Image Analysis Software user guide (Pub. No. MAN0018003), available for download at [thermofisher.com](https://www.thermofisher.com).

## 6. Analyze and annotate saved images

---

### EVOS™ Analysis application

The EVOS™ Analysis application is a quantitative image analysis and annotation tool that runs independently from the EVOS™ M7000 software used for controlling the instrument.

The EVOS™ Analysis application allows you to perform the following tasks:

- Adjust image display settings (page 79)
- Display grid (page 80)
- Display scale bar (page 81)
- Display histogram (page 82)
- Add and show measurements and annotations (page 83)
- Analyze cell culture (page 85):
  - Count cells – Auto Count (page 86)
  - Count cells – Manual Count (page 90)
  - Measure confluence (page 92)
  - Calculate transfection efficiency (page 95)
- Save analysis results (page 98)
- Batch Analysis (page 100)

---

**Note:** For a detailed description of the EVOS™ Analysis application controls, see “EVOS™ Analysis Application” in “Appendix C: Graphical user interface (GUI)” (page 215).

---

#### Launch the EVOS™ Analysis application

There are two ways to launch the EVOS™ Analysis application:

- Launch the application from the Review tab when there is a saved image file open in the Review tab (page 76).
- Launch the application directly from your desktop, then open the image you wish to analyze using the application (page 77).

**Launch EVOS™ Analysis from the Review tab**

1. In the Review tab (page 71), double-click on the image that you wish to analyze to open it in the Viewing area, then click **Open in EVOS Analysis**.

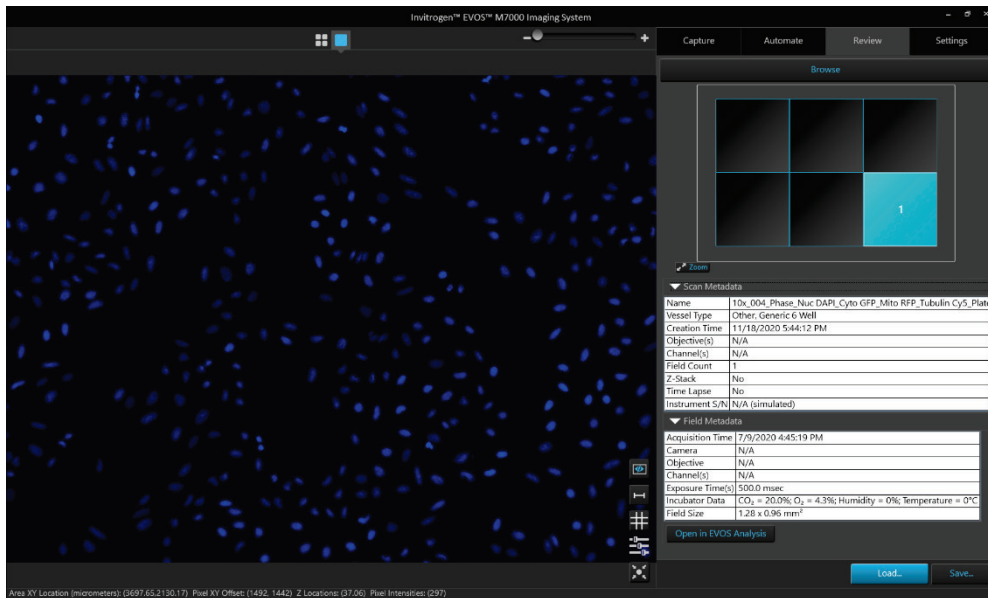

**Open in EVOS Analysis**

The image opens in the EVOS™ Analysis application.

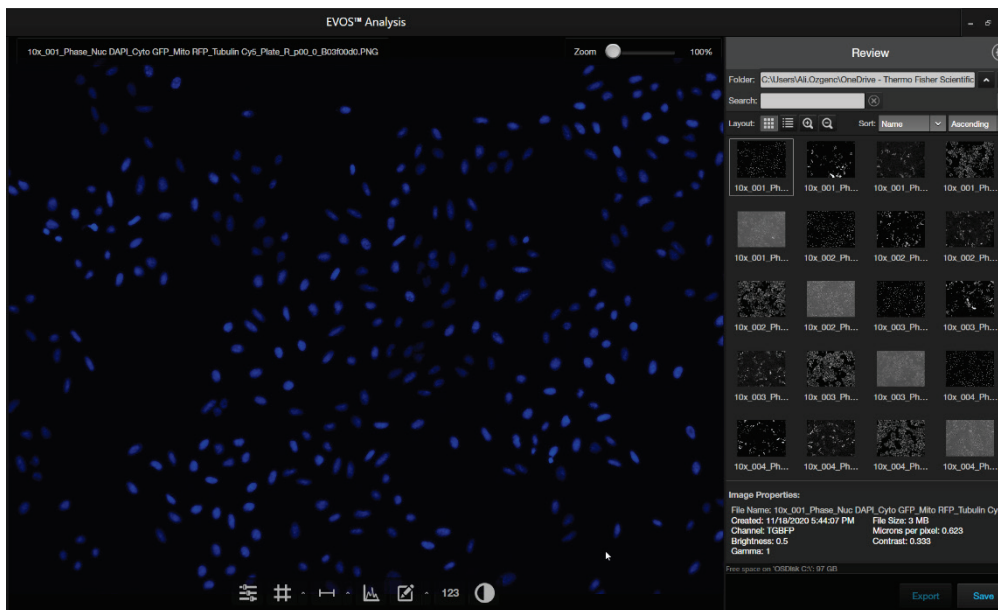

**Note:** The **Open in EVOS Analysis** button becomes available only after you have opened the image you wish to analyze in the Viewing area.

2. Hover the pointer over the Viewing area to reveal Display Settings and Analysis Tools, then click to open the desired tool.



3. To analyze another image, click on the image in the you wish to view it in the Viewing area.

**Launch EVOS™ Analysis from the desktop**

1. Double-click on the **Evos Analysis** icon on your desktop or select it from the Start menu.
2. After the application has opened, navigate to the folder containing images you want to analyze, then double-click to select it.

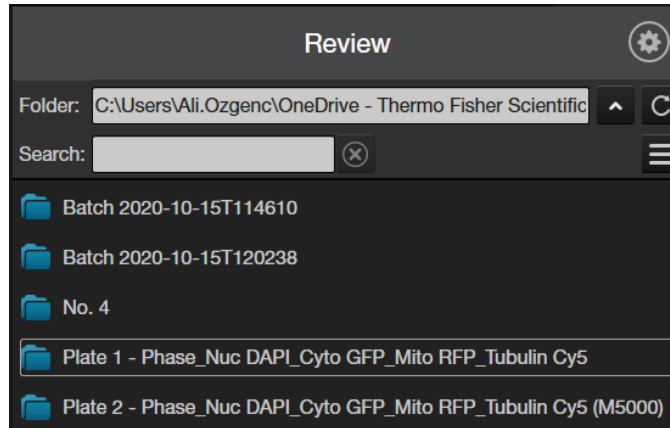

The contents of the selected folder are displayed in the File list/Image preview panel.

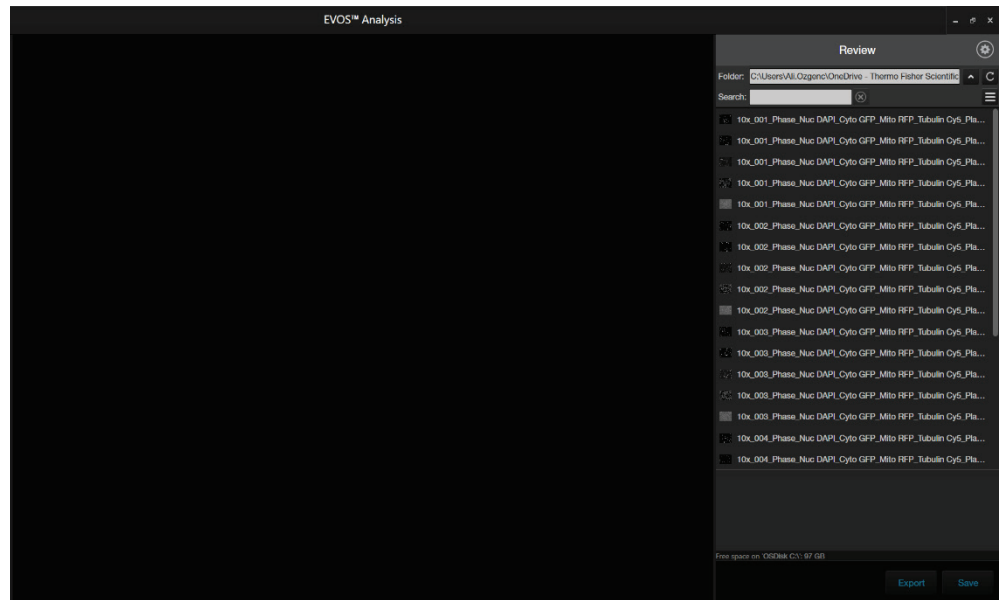

3. To change the layout from File list to Image preview or to sort the files by name, file type, or creation date, click the **Display Settings** button, then make your selections:
  - To toggle between file list and images preview formats, use the **Thumbnails** and **List** buttons.
  - To change the size of the image thumbnails, use the **Zoom** buttons.
  - To sort the image files by **Name**, **File Type**, or **Date Created**, use the **Sort** controls.

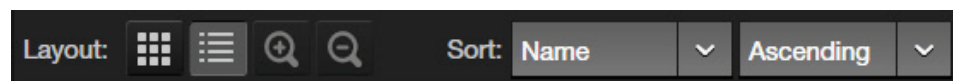

- Click on the image you wish to analyze to open it in the Viewing area.

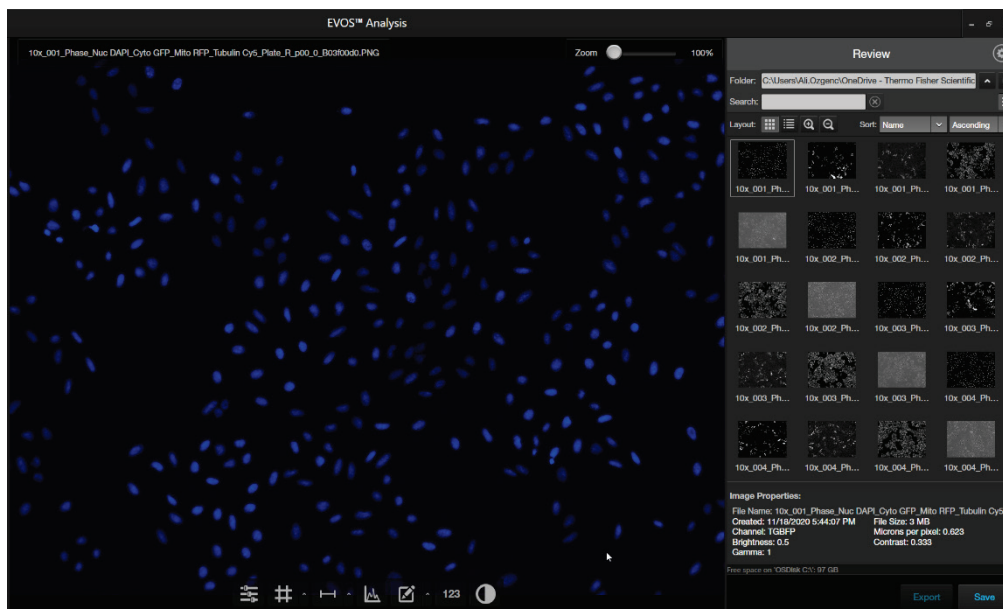

- Hover the pointer over the Viewing area to reveal the buttons for Display Settings and Analysis Tools.



- Click a button to open the corresponding tool; click the button again to close it.

## Image display settings

### Adjust image display settings



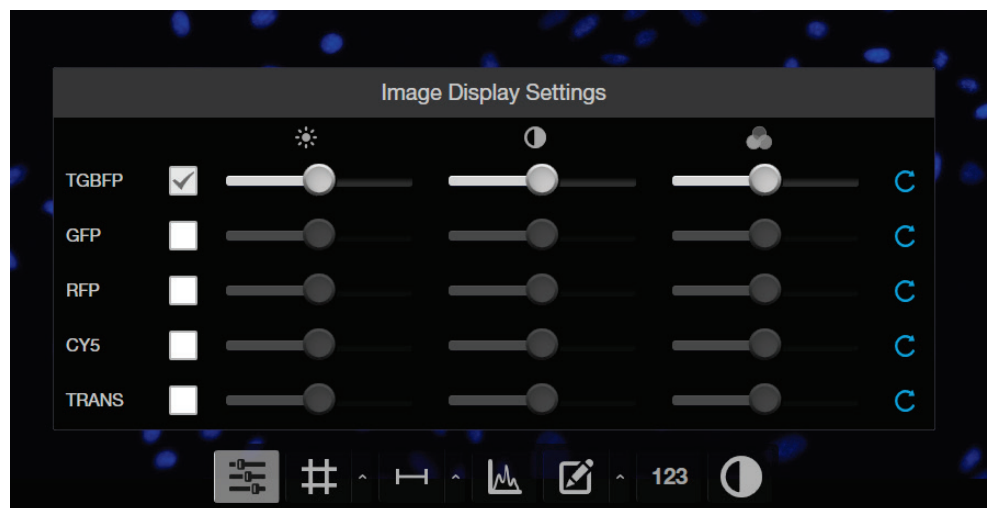

1. Click the **Image Display Settings** button to expand the controls for image display settings (brightness, contrast, gamma). 

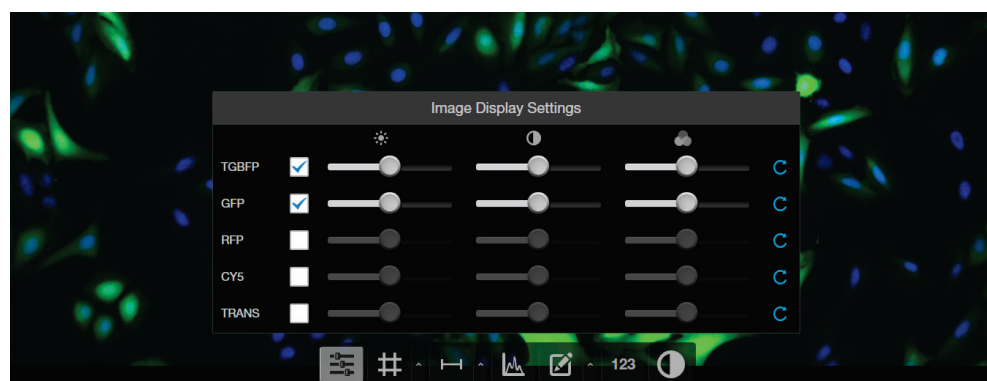

**Note:** The controls for image display settings are available only for captured channels. In the example above, the controls are available for the TGBFP (TagBFP), GFP, RFP, CY5, and TRANS (transmitted light or brightfield) channels. The image that is displayed in the Viewing area is captured in the TGBFP channel, as indicated by the check mark.

2. *Optional:* To display an additional channel, select the corresponding checkbox. To remove a channel from displaying in the Viewing Area, unselect the corresponding checkbox. In the example below, TGBFP and GFP channels are displayed.



3. Adjust the **Brightness** , **Contrast** , and **Gamma**  settings for each of the selected channels using the corresponding sliders.
4. Click the **Reset** button  to return the image display settings to their default values.
5. Click the **Image Display settings** button again to collapse the controls.



# Grid

## Display grid

1. Click the **Grid** button to superimpose a grid over the Viewing area.

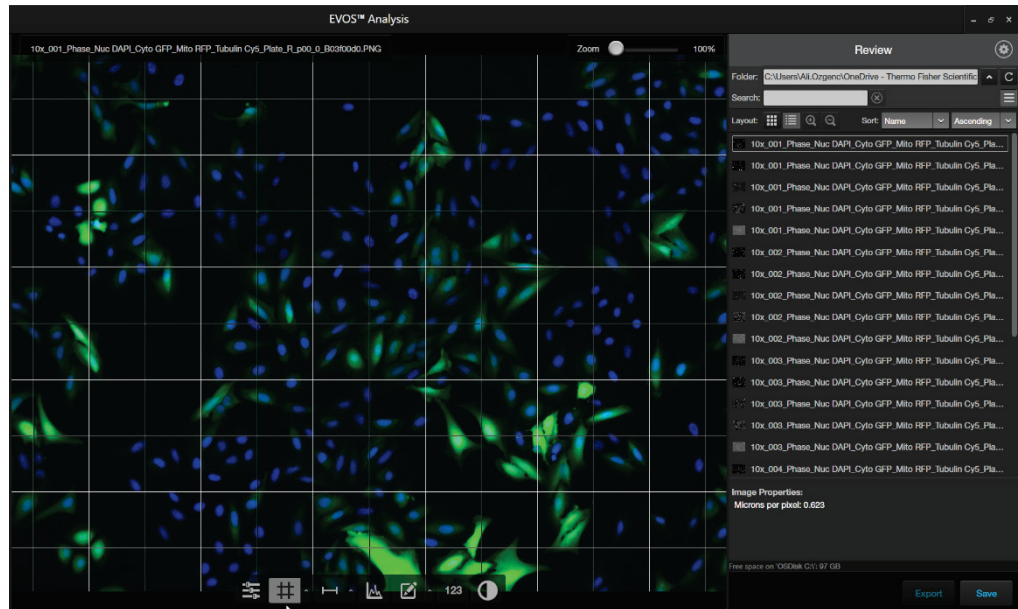

2. To change the grid size, click the **Grid Settings** button (arrow on the Grid split button) to open the Grid Settings tool.

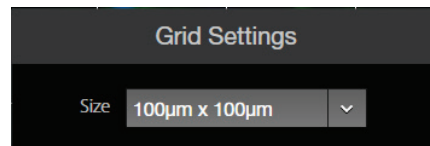

3. Select the **Size** for the grid. Available grid sizes depend on the magnification of the selected objective.
4. Click the **Grid Settings** button again to save your settings and close the tool.



# Scale bar

## Display scale bar

1. Click the **Scale Bar** button to superimpose a scale bar over the Viewing area.

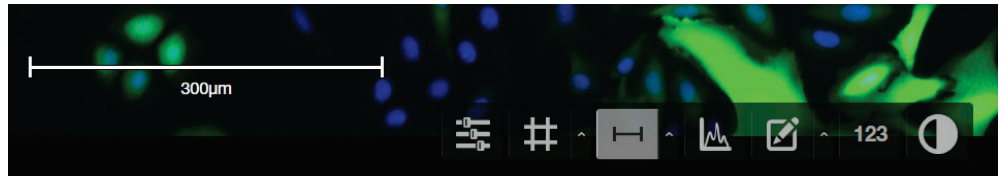

2. To move the scale bar, hover your pointer over the scale bar until a bounding box appears, then click within the box and drag the scale bar to the desired location within the Viewing area.

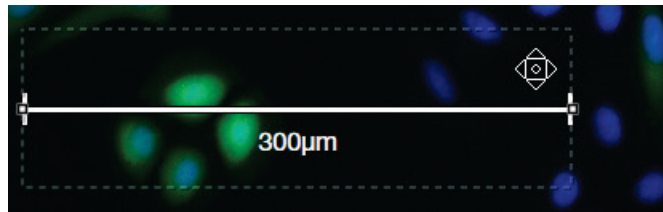

3. To adjust the length of the scale bar, hover your pointer over the scale bar until a bounding box appears, then click left or right side of the box and drag the box to the desired length.

You can adjust the length by pre-fixed increments based on the objective magnification.

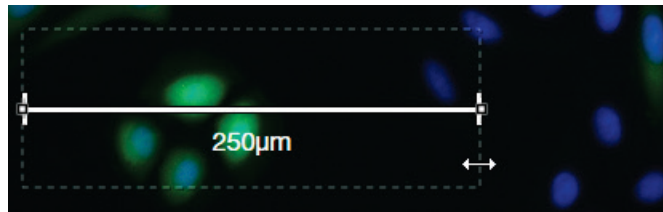

4. To change scale bar settings, click the **Scale Bar Settings** button (arrow on the Scale Bar split button) to open the Grid Settings tool.

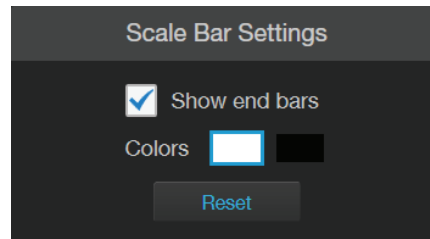

5. Select **Show End Bars** to display the scale bar with the end bars.
6. Select the **Color** for the scale bar.
7. Click **Scale Bar Settings** button again to save your settings and close the tool.

# Histogram

Display histogram

1. Click the **Histogram** button to open the Pixel Intensity histogram.

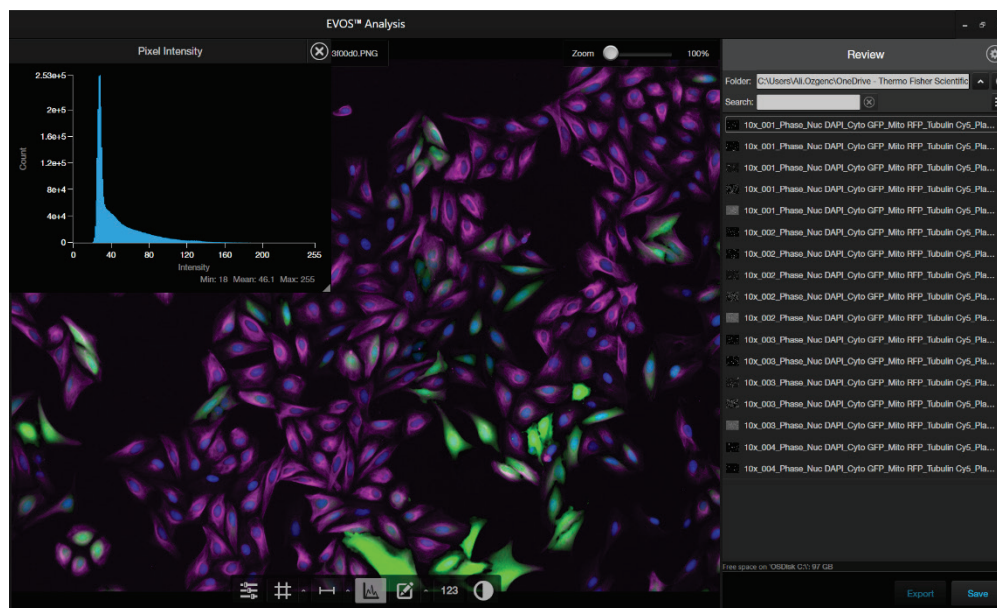

2. Pixel Intensity histogram shows the Pixel count vs. Intensity data of the image displayed in the Viewing area as well as the minimum, mean, and maximum pixel intensities.

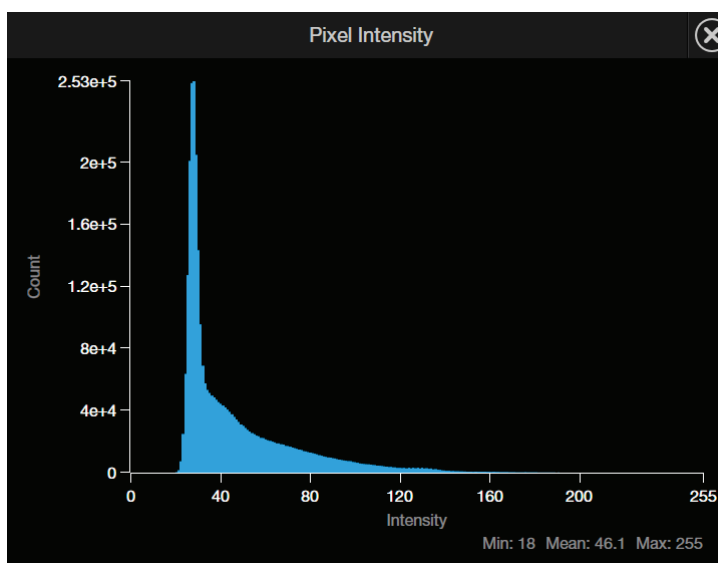

3. To move the histogram, click within the plot heading area and drag the plot to the desired location.
4. To resize the histogram, click the grey triangle at the lower right corner of the plot, then drag the plot to the desired size.
5. Click the **Histogram** button again to close the Pixel Intensity histogram. Alternatively, click the **X** on the plot to close the histogram.

# Measurements and Annotations

Add and show measurements and annotations

1. Click the **Measurement and Annotations** button to open the controls to add measurements and annotations.

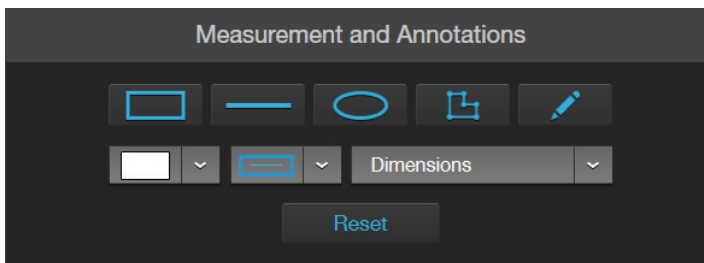

2. Using the **Annotations** tools, draw a **rectangle**, **line**, **ellipse**, **polygon**, or a **free-form** shape over the region of interest on the Viewing area. You can draw multiple shapes of different type.

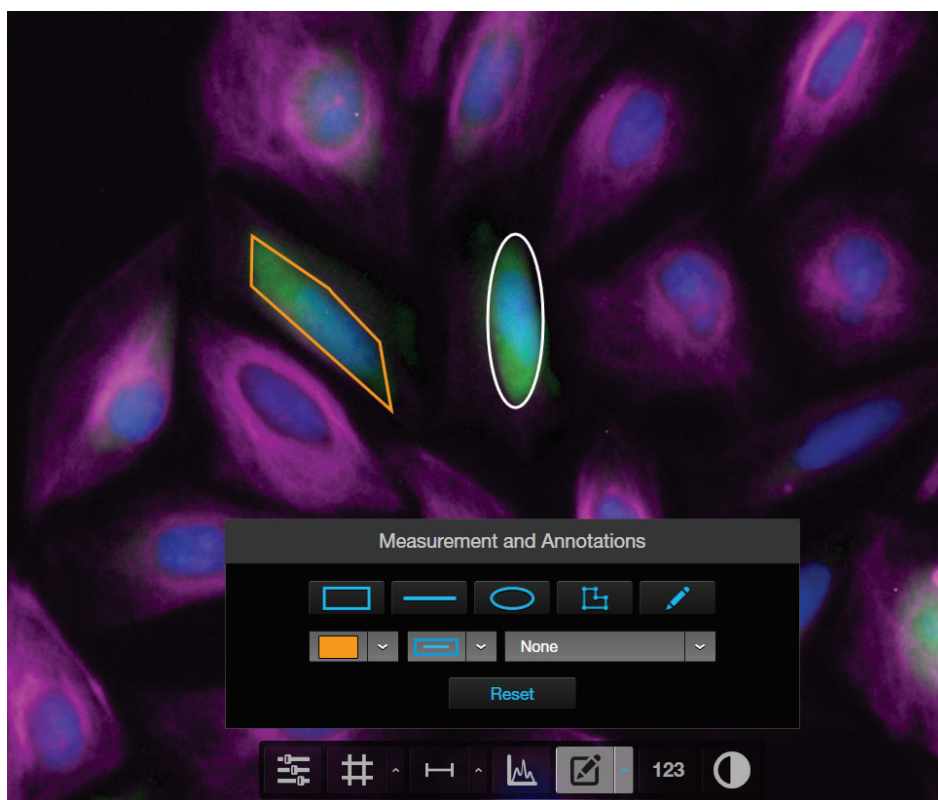

3. If needed, change the **Color** and **Thickness** of the annotation to make it more visible over the image.

4. If desired, select to display the **Dimensions**, **Area**, or **Perimeter** information for the selected annotation from the dropdown menu.

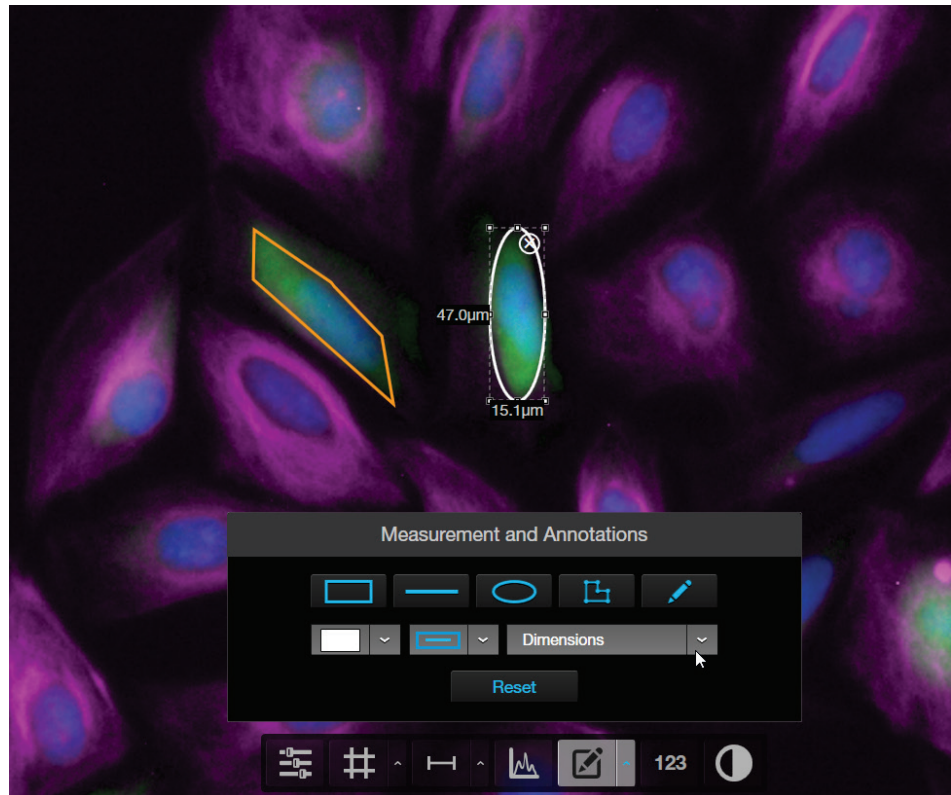

5. To delete a selected annotation, click the X on the shape that appears when you hover your pointer over it.  
To delete all annotations, click **Reset**, then click **OK** in the dialog that opens.

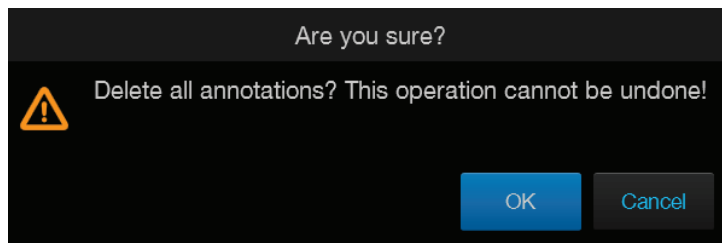

6. Click the **Measurement and Annotations** button again to close the tools.
7. After you have added measurements and annotations to your image:
  - Click **Show Measurements and Annotations** button (main part of the split button) to turn the display on and off.
  - Click **Measurement and Annotations Controls** button (the arrow on split button) to display the controls to add new measurement and annotations or to delete existing ones.

## Analyze cell culture

### Analysis tools

Hover the pointer over the Viewing area in the EVOS™ Analysis application to reveal the analysis tools, then click the **Show Cell Count** button to display **Auto Count**, **Manual Count**, and **Cell Culture** options in the tabs area.

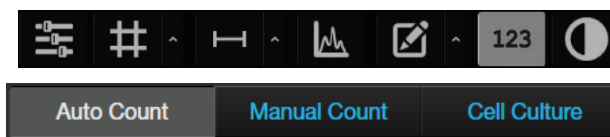

- **Auto Count:** Automatically counts the objects displayed in the Viewing area based on your specifications (page 86). With Auto Count, you can count objects only in a single fluorescence channel (nuclear stain channel).
- **Manual Count:** Allows you to tag objects in the Viewing area with up to six labels. As you tag objects, the system keeps a running tally of the counts with percentages for each label assigned (page 90). With Manual Count, you can count objects in multiple channels simultaneously.
- **Confluence:** Allows you to select up to five reference objects for the target (i.e., cells) and one background reference in your image, then automatically calculates the percentage confluence of your culture (page 92).
- **Transfection Efficiency:** Allows you to estimate the transfection efficiency of your culture by calculating the ratio of fluorescence area (i.e., cells expressing the fluorescence marker) to the total cell area in your culture (page 95).
- **Batch Analysis:** Allows you to save and apply the analysis parameters set in Auto Count, Confluence, and Transfection Efficiency tools to other images that you have collected and saved an image folder (page 100). Batch Analysis is not available for Manual Count.

---

**IMPORTANT!** For analysis, only use 16-bit Raw image files, not Display or Merged image files. Raw image files contain the full dynamic range and metadata needed for quantitative analysis, whereas Display and Merged image files do not.

---

# Count cells – Auto Count

## Perform Auto Count

1. Click the **Show Cell Count** button, then select **Auto Count**.

123

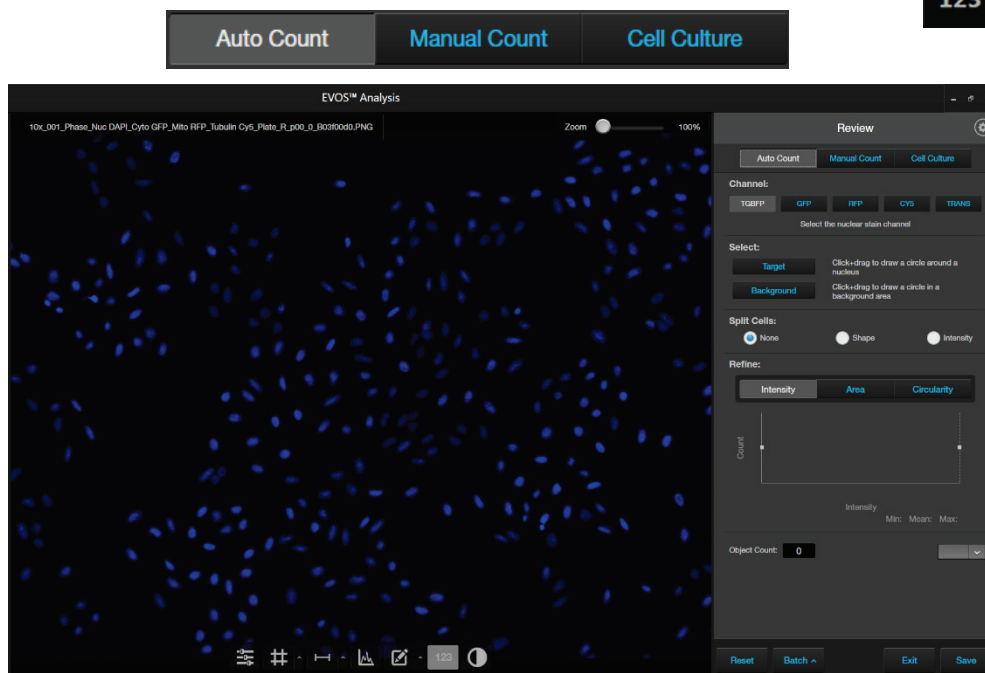

2. Select the **nuclear stain channel** in which to count objects.

Available options depend on the channels used when the image was captured. In this example, TGBFP (TagBFP), GFP, RFP, CY5, and TRANS (transmitted light) channels contain captured images, and TGBFP is selected for auto count.

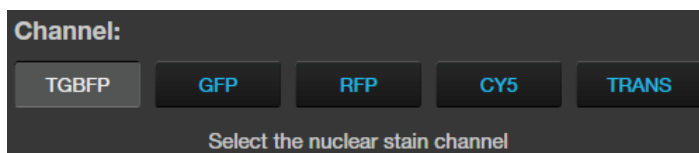

3. To identify the target objects to include in your count, click **Target**, then click and drag to draw a circle (blue) around a nucleus.

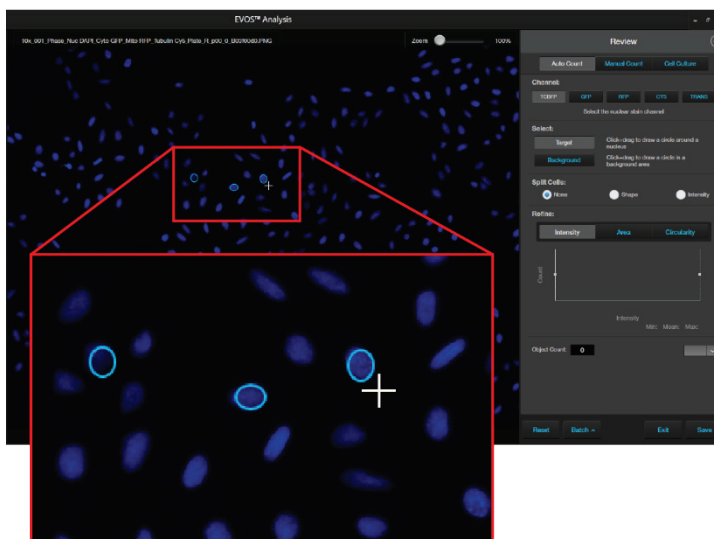



- If desired, click **Target** again to identify other nuclei (for example, nuclei that might appear different) to improve the accuracy of your count.

**Note:** For best results, follow these guidelines when identifying target objects:

- When selecting objects, circle the entire object and include a slight border around it.
- To include objects of lower intensity in your count, select dimmer objects during identification.
- Circle only one object at a time to help define object size for segmentation.

- To distinguish the target from background, click **Background**, then click and drag to draw a circle (orange) in a background area.

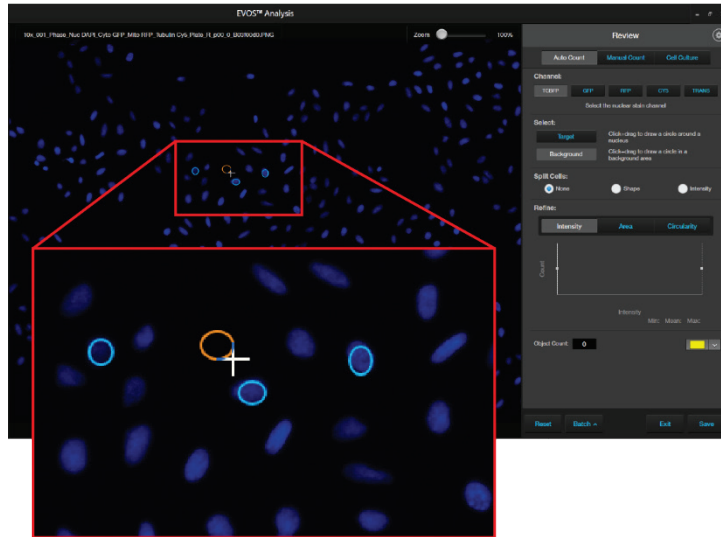

- After you define the target and background areas, the software automatically counts the objects based on your criteria.

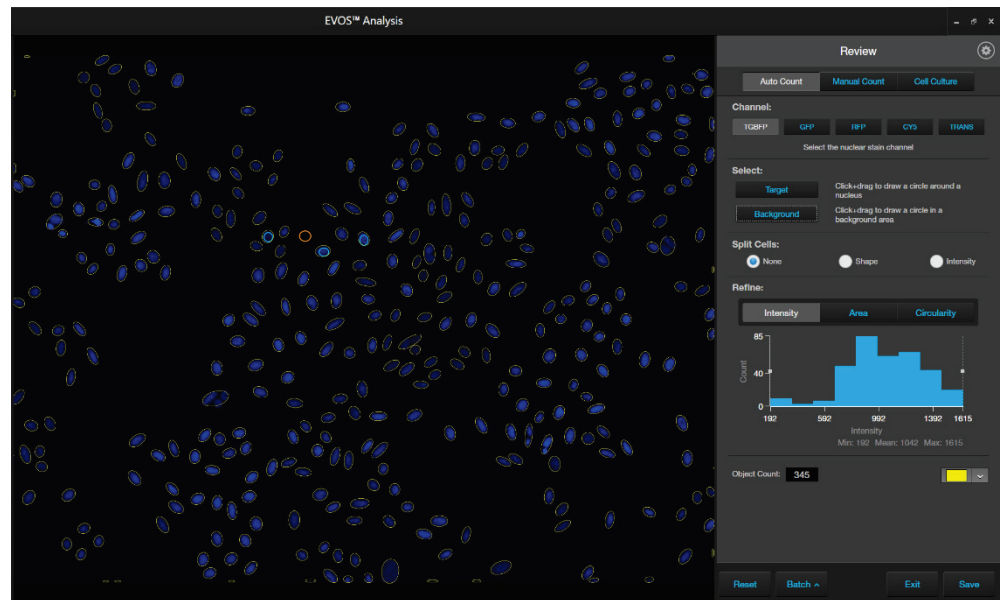

Viewing area identifies the objects that were counted with colored circles (in this example, yellow) and the Object Count field displays the number of objects included in the count.

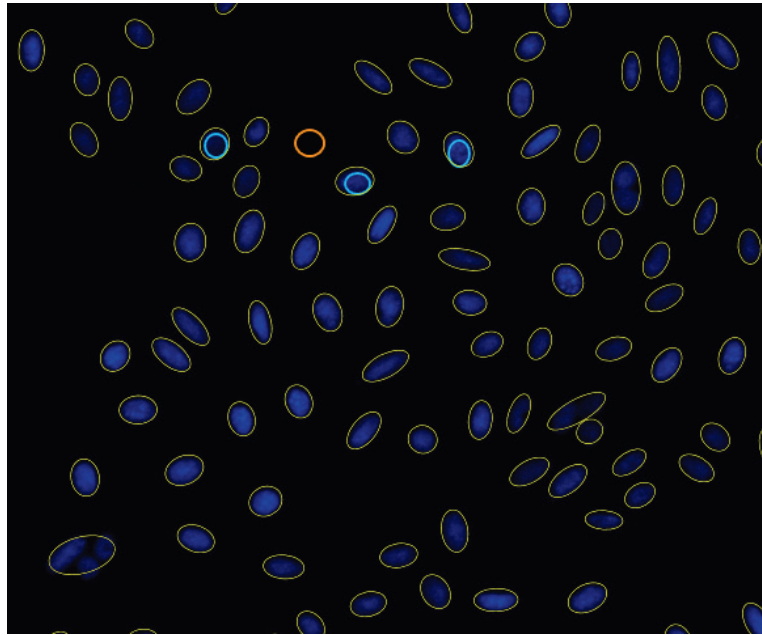

Object Count: 345

---

**Note:** Depending on the quality of the image and your selection of representative target cells and background, the auto count algorithm can overcount or undercount the cells in the image.

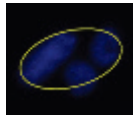

Undercount – 3 cells counted as 1



Overcount – 1 cell counted as 2

To obtain a more accurate count:

- Split cells by shape or intensity.
- Refine your count by intensity, area, or circularity.

- 
7. To count closely grouped cells that are touching or overlapping as distinct objects, select from the **Split Cells** options:

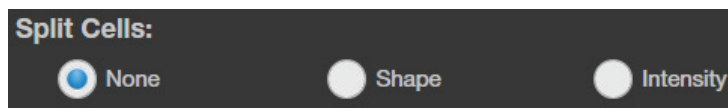

- **None:** Touching or overlapping objects are not counted separately.
- **Shape:** Distinct objects are identified and counted based on shape.
- **Intensity:** Distinct objects are identified and counted based on pixel intensity.



- The Refine section displays a histogram that shows **Count** versus **Intensity**, **Area**, or **Circularity**. In this example, **Area** is selected.

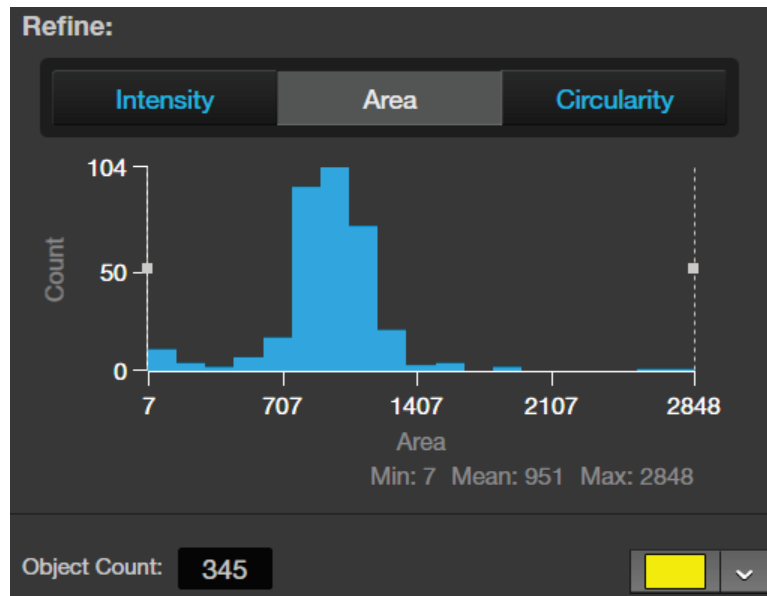

- To refine your count, select **Intensity**, **Area**, or **Circularity**, move the gate handles to set the upper or the lower boundary for the selected parameter. You can refine the count by a single parameter or by multiple parameters. The software applies the selected boundaries and recalculates the count.

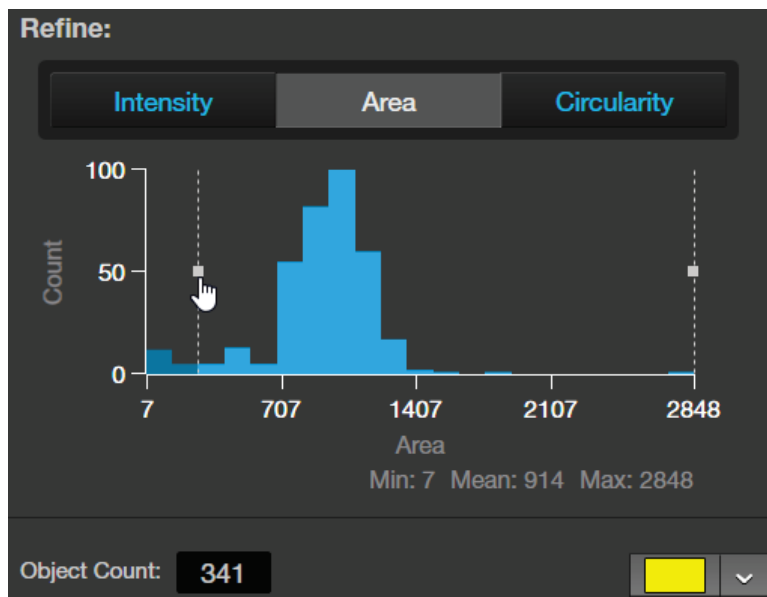

- When finished with the count, save your count results (see “Save analysis results”, page 96).
- To save your count settings for Batch Analysis, see “Save current analysis settings”, page 100.

# Count cells – Manual Count

## Perform Manual Count

1. Click the **Show Cell Count** button, then select **Manual Count**.

123

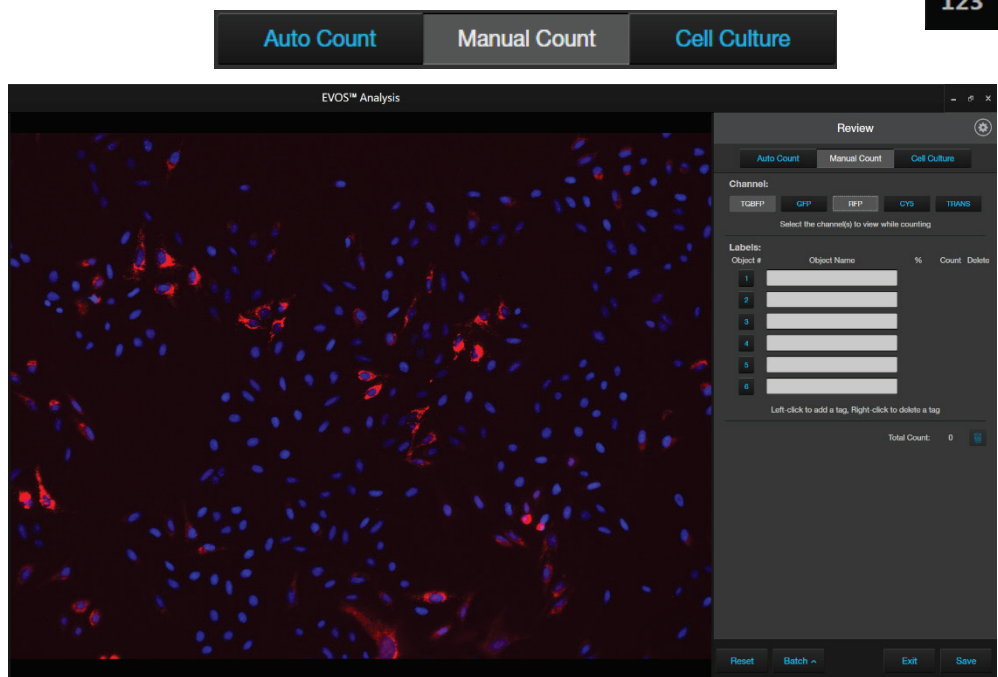

2. Select the **Channels** to display in the Viewing area for manual count. You can select multiple channels that contain captured images.  
In this example, TGBFP (TagBFP) and RFP channels are selected for the manual count.

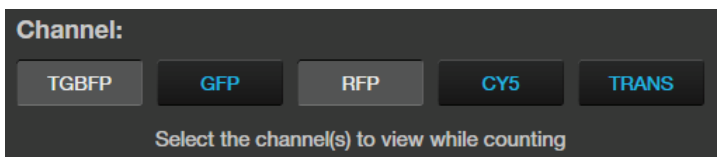

3. Click in an **Object Name** field to enter a name for that label. You can use up to six labels for the manual count.

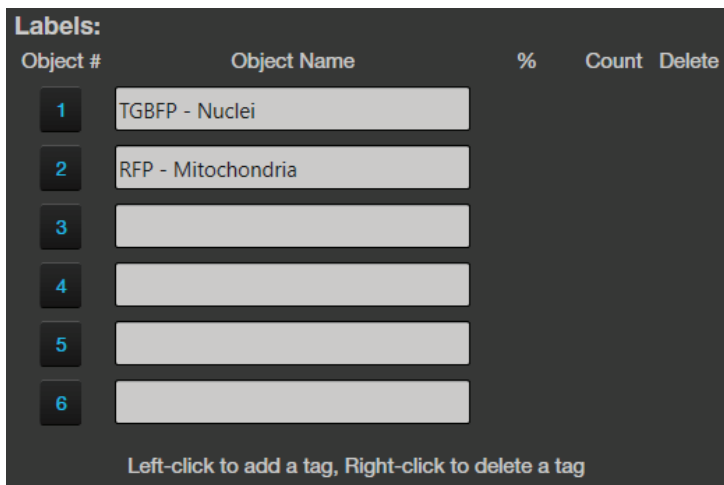

- Click on the **Object #** to select a label, then left-click on the objects in the Viewing area to tag them with that label. You can switch labels as desired.

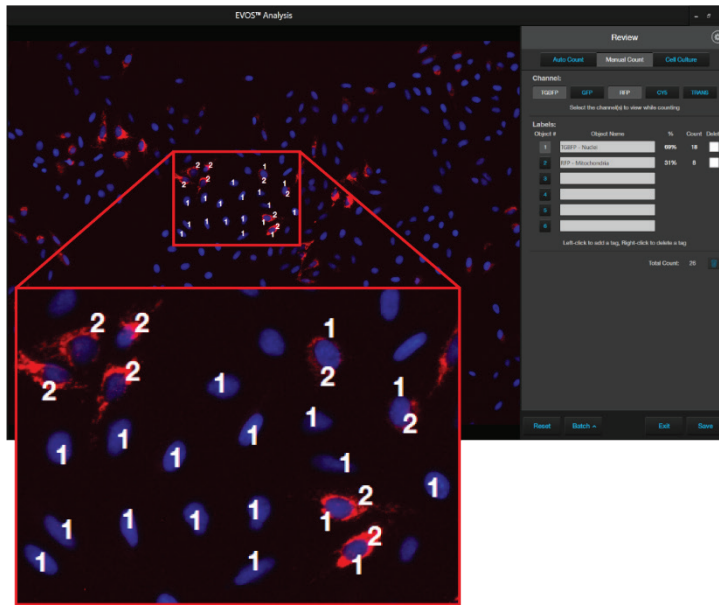

As you tag the objects onscreen with the selected label, the system keeps a running tally of the counts with percentages for each label assigned.

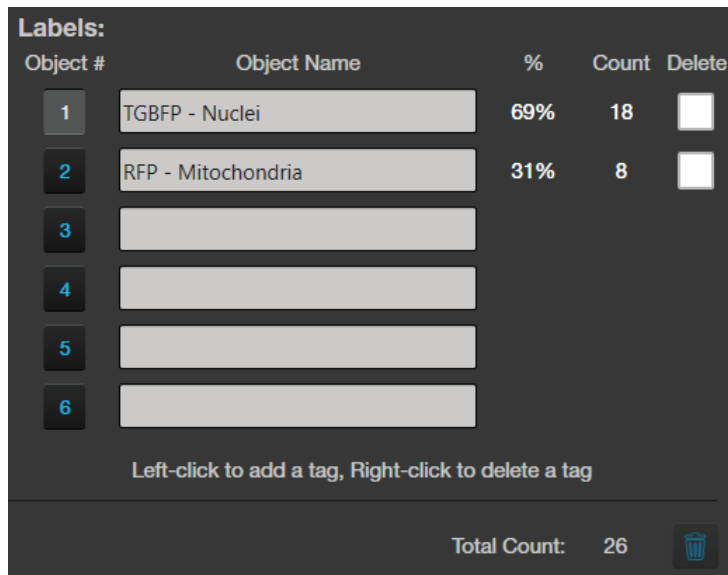

- To delete a tag, right-click on the tag you wish to delete.
- To delete all tags for a label, check the **Delete** box for the label, then click the **Trash** button.
- To delete all tags for all labels, check the **Delete** boxes for each label, then click the **Trash** button.
- When finished with the count, save your count results (see “Save analysis results”, page 96).



# Measure confluence

## Confluence tool

Confluence is a measure of how densely cells are distributed in culture. When all available growth area is utilized in a culture vessel and the cells make close contact with one another, the culture is at 100% confluence.

The Confluence tool measures the percent area covered by cells in the image, which is required to calculate transfection efficiency.

## Guidelines for confluence measurements

- We recommend that you visualize your cells using transmitted light and a phase objective with **4X to 10X** magnification. Set the phase ring to **Oly 4x** (for Olympus™ 4X phase objective) or **4x/10x** (for EVOS™ phase objectives) using the phase annuli selector (page 8).
- For analysis, only use 16-bit Raw image files, which contain the full dynamic range and metadata needed for quantitative analysis.
- In the analysis tool, increasing the number of targets and background areas improves accuracy. You can select up to 5 target areas and 5 background areas.
- The Confluence tool uses a texture and intensity-based algorithm. The sensitivity slider adjusts the algorithm sensitivity to pixel intensity (higher intensity = more pixels included). Decreasing the sensitivity reduces the confluence value.
- Different cell types have different confluence “patterns”, and variability in morphology and contrast can influence the absolute confluence measurement between different cell types. However, within a given cell type, you can optimize the reproducibility of your measurements. Reproducibility in confluence measurements is more important than absolute percentages.

## Measure confluence

1. In the EVOS™ Analysis application, open the image captured in the transmitted light channel.

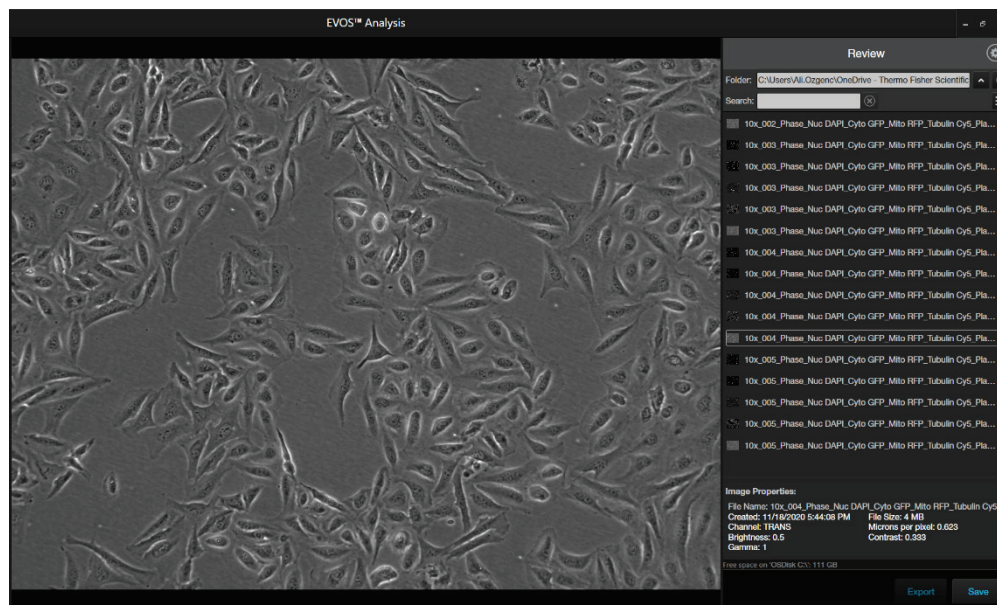

2. Move the pointer to the Viewing area to reveal **Display Settings and Analysis Tools**, then click the **Show Cell Count** button.





3. In the tabs area, select **Cell Culture** to display the Confluence tool.

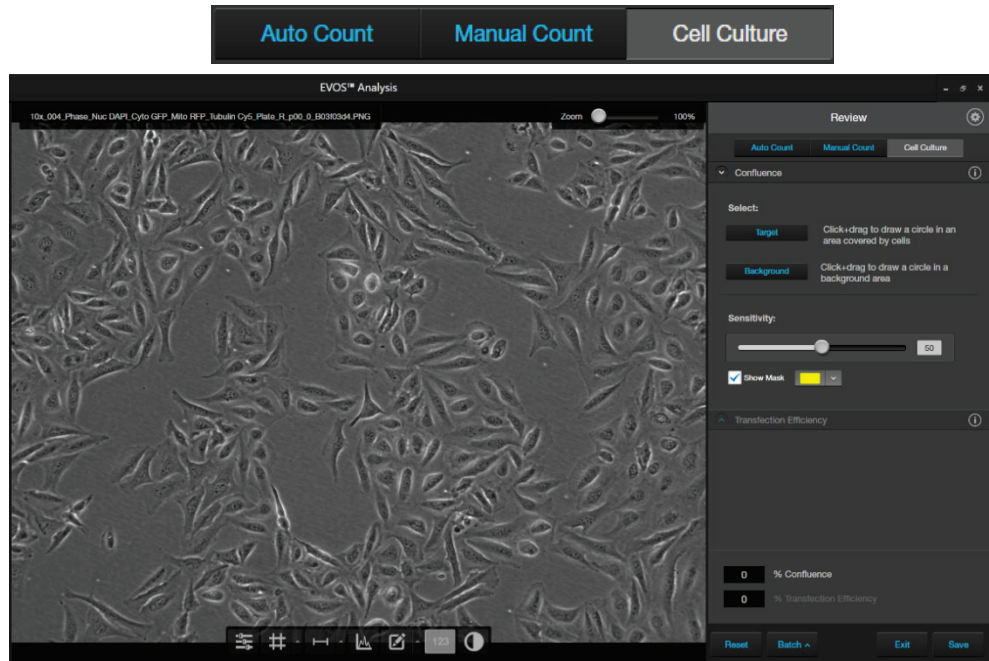

4. Click **Target**, then click and drag to draw a circle around an area that contains cells (blue circle).
5. Click **Background**, then click and drag to draw a circle around a background area that does not contain any cells (orange circle).

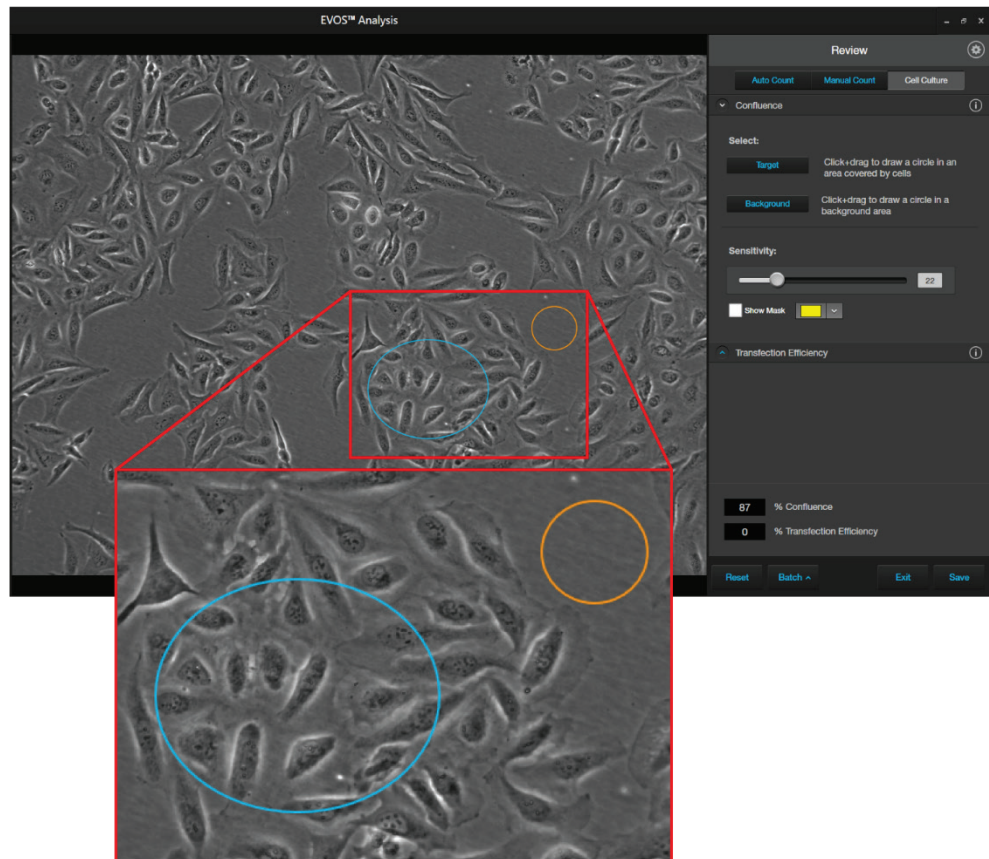
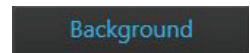
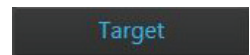

---

**Note:** You can select up to 5 targets and 5 background areas. Increasing the number of targets and background areas improves the accuracy and reproducibility of the confluence measurements.

---

- The software automatically calculates the confluence of your culture and displays the results as a percentage of confluence.

73 % Confluence

- To view the areas of the image counted as Target, select **Show Mask**. The areas counted as Target are highlighted in the selected color.

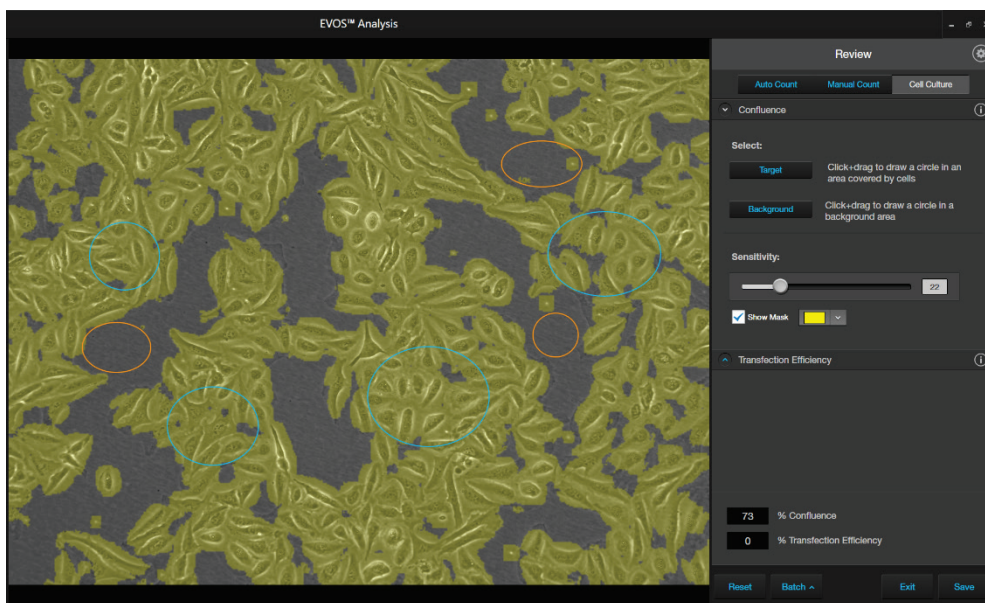

- Refine the sensitivity of the Confluence measurement using the **Sensitivity** slider.

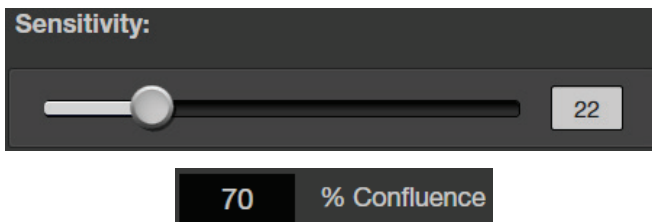

---

**Note:** As you adjust sensitivity, observe the image with the **Show Mask** option on. Ensure that the target areas are selected with minimal coverage of the background areas. Note that decreasing the sensitivity reduces the confluence value.

---

- When you complete the confluence measurement, Transfection Efficiency tool becomes available. To calculate transfection efficiency, go to "Calculate transfection efficiency", page 95.
- To save your Confluence results without calculating transfection efficiency, click **Save** (see "Save analysis results", page 98).
- To save your confluence measurement settings for Batch Analysis, see "Save current analysis settings", page 100.

# Calculate transfection efficiency

## Transfection Efficiency tool

Transfection of a cell population typically results in a varying number of cells expressing the desired genes of interest. Transfection efficiency is the percentage of cells that are transfected compared to the entire population.

The Transfection Efficiency tool calculates the fluorescence area (transfected cells expressing the fluorescence marker) divided by the entire cell area in the image.

**IMPORTANT!** For analysis, only use 16-bit Raw image files, which contain the full dynamic range and metadata needed for quantitative analysis.

## Calculate transfection efficiency

1. After you have completed the confluence measurement, click **Transfection Efficiency** to expand the controls for the Transfection Efficiency tool.
2. Select the **Fluorescence Channel** for which you wish to measure the transfection efficiency.

In this example, we want to calculate the percentage of cells that express GFP. Therefore, the **GFP** channel is selected. The **Fluorescence Channel** and the **Transmitted Light Channel** options are also checked, so that both channels are displayed in the viewing area.

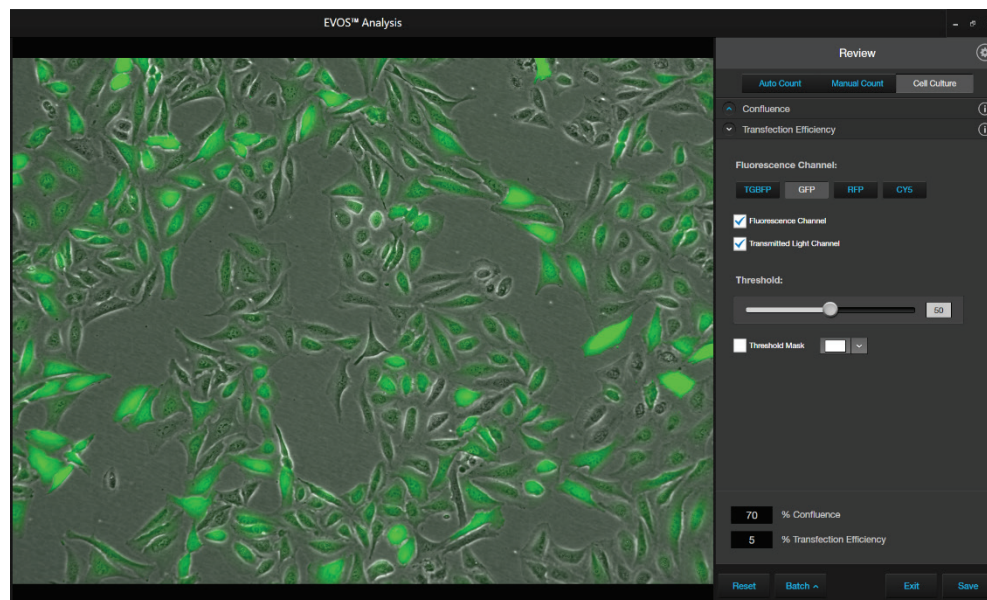
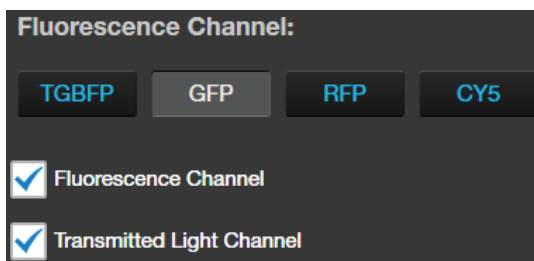

The software automatically calculates the Transfection Efficiency and displays the results as % Confluence and % Transfection Efficiency.

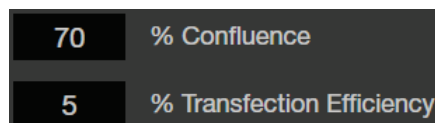



---

**Note:** Transfection Efficiency calculation is based on the final measured confluence (Step 8, page 94) and the fluorescence area that is above the set fluorescence threshold value. To refine the Transfection Efficiency calculation, adjust the Threshold such that only the cells that express at the desired level are included in the calculation (see page 97).

---

3. To view the pure fluorescence signal and to observe the various levels of fluorescence marker (GFP) expression, uncheck the **Transmitted Light Channel**.

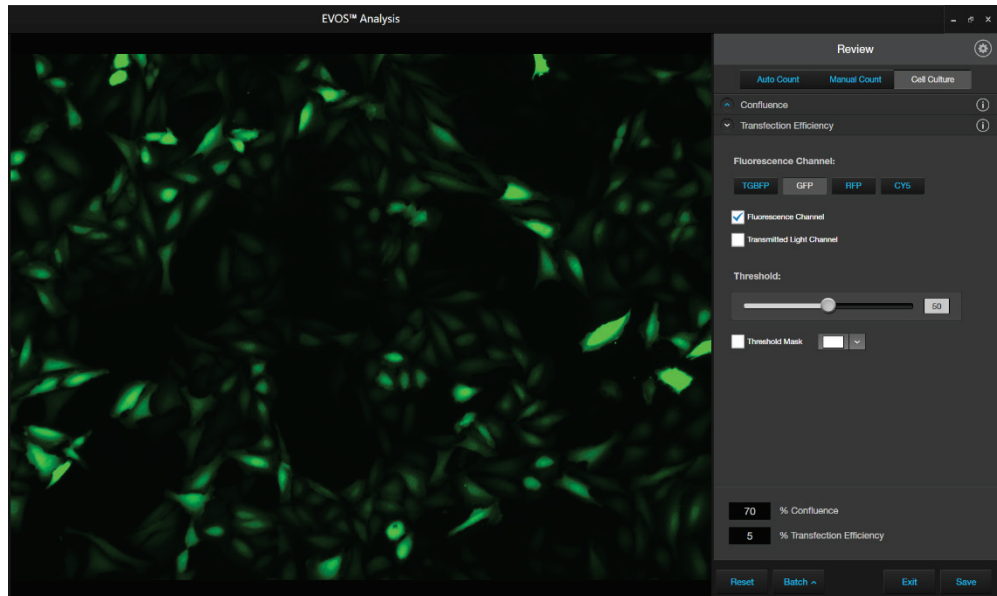

4. Select **Threshold Mask** to highlight the fluorescence areas included in the Transfection Efficiency calculation.

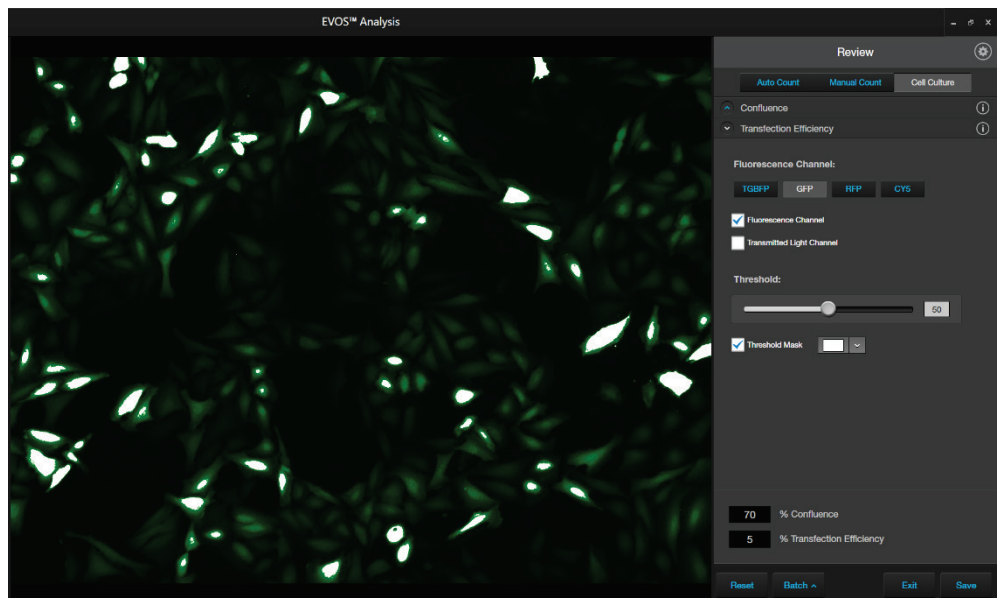



- To refine the Transfection Efficiency calculation, adjust the **Threshold** slider until all the cells that express at the desired level are included in the calculation.



**Note:** Viewing the image only in the **Fluorescence Channel** and toggling the **Threshold Mask** on and off will help you determine the best **Threshold** value for your experiment.

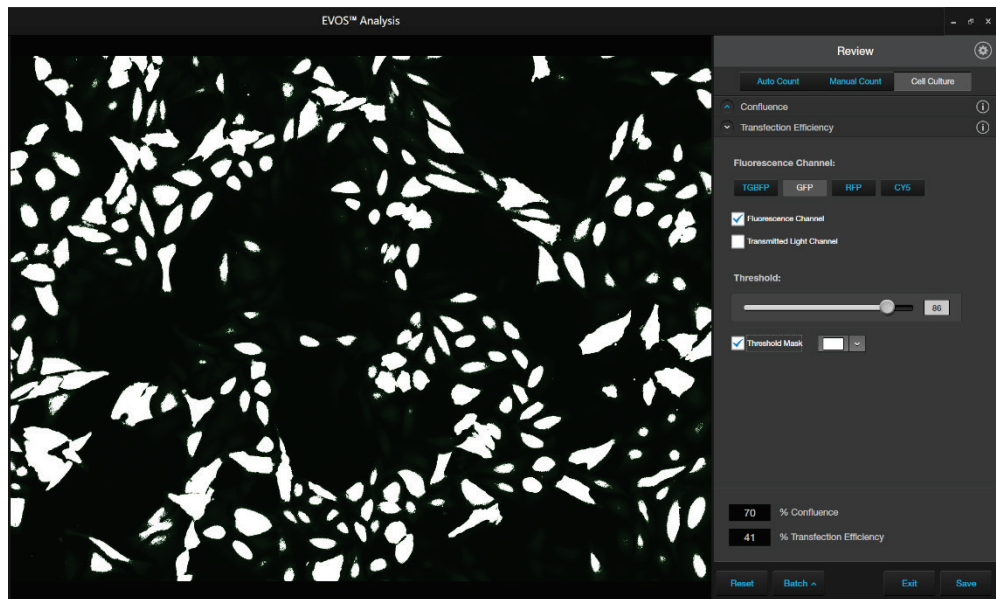

As you adjust the **Threshold**, the software updates the calculation and displays the new Transfection Efficiency value.

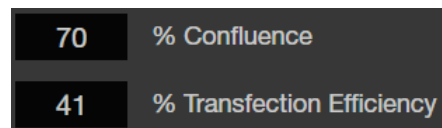

- To save your Confluence and Transfection Efficiency results, go to "Save analysis results", page 98.

## Save analysis results

### Save

1. When finished with the Auto count, Manual count, or Cell Culture analysis (Confluence and Transfection Efficiency), click **Save** to open the Save Composite Image dialog, then navigate to the destination folder to save your count results.

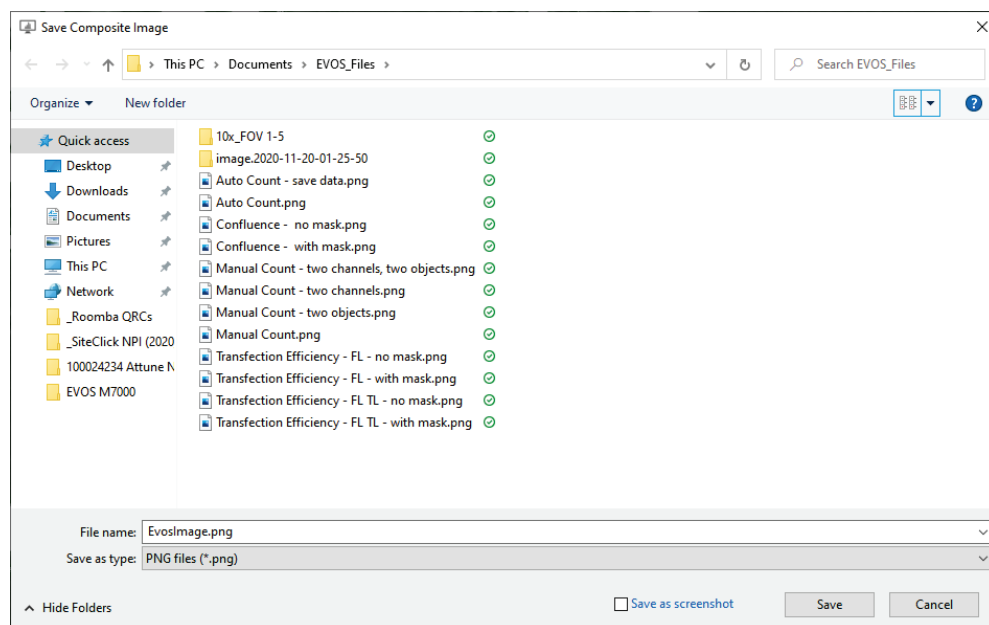

2. Enter **File name** and select **File type**.
3. If desired, select **Save screenshot** to preserve a detailed account of your count results as a screenshot of the software user interface.  Save screenshot  
When Save screenshot is not selected, the software only saves the image as displayed in the Viewing area. The saved image includes analysis results as well counted objects, selected target and background areas, tags, in the selected channels with or without mask as applicable to the analysis tool used.  
Table 1 (page 99) lists the various options available for saving analysis results.
4. If you have performed an Auto count, select **Save data** to save a separate CSV file of the count results with individual object brightness, area, and circularity data.  Save data  
This option is not available with Manual count, Confluence measurement, or Transfection Efficiency calculation.
5. Click **Save** to save your analysis results.
6. To save your Transfection Efficiency calculation settings for Batch Analysis, see "Save current analysis settings", page 100.

**Table 1.** Save options for analysis tools.

	<b>Save</b>	<b>Save as screenshot</b>	<b>Save data</b>
<b>Auto Count</b>	Image and object count; counted objects and user selected target and background areas identified	Image (same as Save) and Auto Count tab with object count, histogram, and count options as displayed in the Auto Count tool	Separate image (same as Save) and CSV files; CSV file contains brightness, area, and circularity data
<b>Manual Count</b>	Image and total object count; object labels as tagged by user during count	Image (same as Save) and Manual Count tab with labels, object counts, percentages, and total count as displayed in the Manual Count tool	N/A
<b>Confluence</b>	Image in transmitted light channel (with or without mask) and % confluence; user selected target and background areas identified	Image (same as Save) and Cell Culture Confluence tab with % confluence and sensitivity as displayed in the Confluence tool	N/A
<b>Transfection Efficiency</b>	Image in selected channels (with or without mask), % confluence, and % transfection efficiency in the fluorescence channel	Image (same as Save) and Cell Culture Transfection Efficiency tab with % confluence, % transfection efficiency, threshold, and other options as displayed in the Transfection Efficiency tool	N/A

N/A: Not applicable.

# Batch Analysis

## Batch Analysis function

Batch analysis allows you to save and apply the analysis parameters set in Auto Count, Confluence, and Transfection Efficiency tools to other images that you have collected and saved in an image folder.

Batch Analysis function is available as a Save Settings-Run Analysis split-button on the Auto Count and Cell Culture tabs of the EVOS™ Analysis application. It is not available for Manual Count.

---

**IMPORTANT!** Images to be batch analyzed should all be of the same cell type and have the same magnification and illumination settings. For consistent measurements, do not mix different cell types, magnifications, or illumination settings in the same folder when performing batch analysis.

---

---

**IMPORTANT!** For batch analysis, only use 16-bit Raw image files, which contain the full dynamic range and metadata needed for quantitative analysis.

---

## Save current analysis settings

1. When finished with the Auto count, Confluence measurement, or Transfection Efficiency calculation, click **Batch**, then select **Save Settings**.

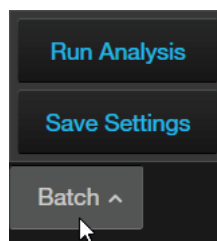

2. Enter the name for the settings, then click **Save**. The current analysis settings are saved for reuse, which you can apply to other images that you have collected and saved an image folder.

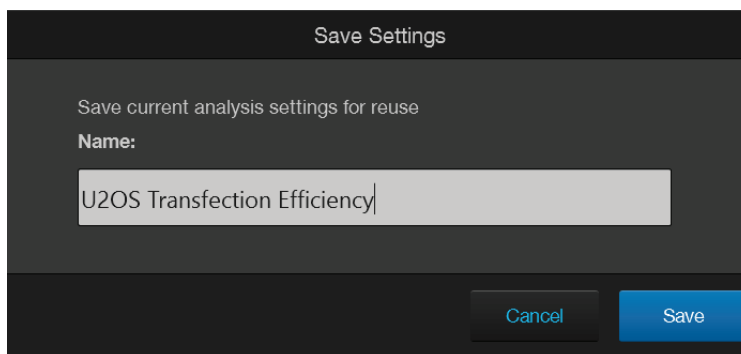

## Run Batch Analysis

1. Navigate to the folder that contains the images you wish to analyze using the Batch Analysis tool, then click on a representative image to open it.
2. Perform Auto count, Confluence measurement, or Transfection Efficiency calculation on the open image as described previously.
3. To analyze the remaining images in the same image folder, click **Batch**, then select **Run Analysis**.

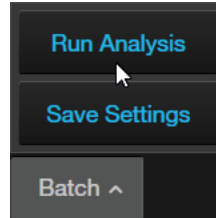

**Note:** You can also directly run Batch Analysis for images in an image folder using previously saved Batch Analysis settings without first performing Auto count, Confluence measurement, or Transfection Efficiency calculation (see Step 4).

4. Select the **Settings** to use for Batch analysis.
  - To use the current analysis settings (i.e., analysis parameters that you have used in Step 2), select **Current Settings**.
  - To use previously saved analysis settings, select the desired option from the **Select Settings** list. You can sort the list by fluorescence channel, date created, or last date used.

In this example, the previously saved **U2OS Transfection Efficiency** setting is selected.

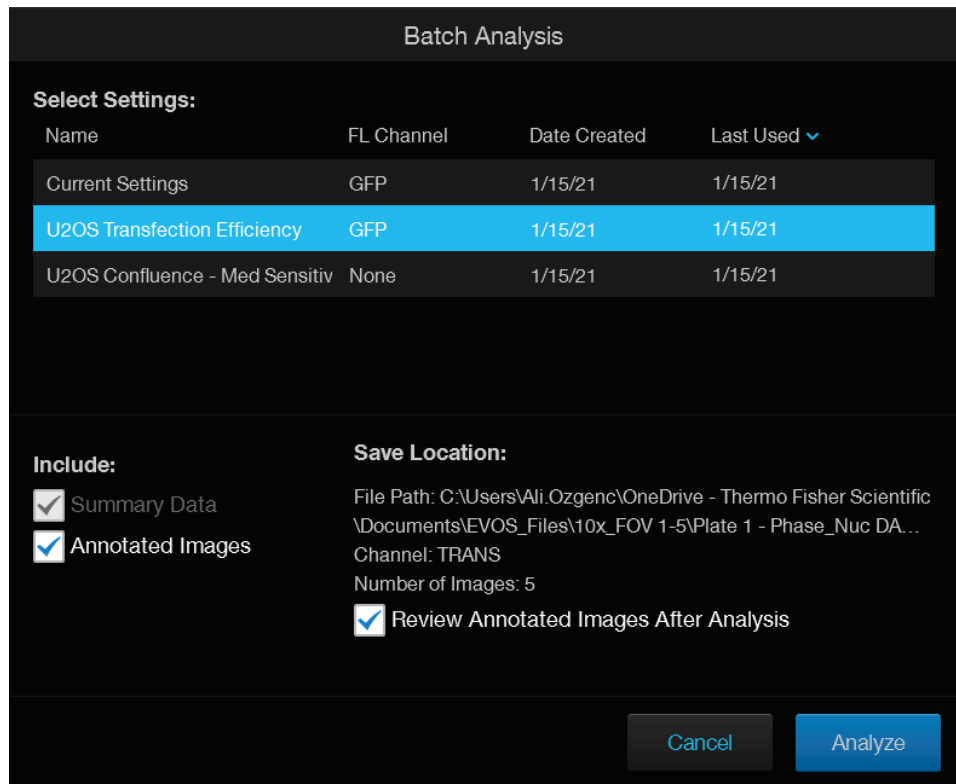

5. To embed the measurements from the batch analysis in the images so that you can compare them after the analysis, select **Annotated Images**.

---

**Note:** **Summary Data** is always selected. After the analysis, summary data is included in the analysis folder as a separate CSV file.

---

6. To review the annotated images immediately after the analysis is complete, select **Review Annotated Images After Analysis**.
7. Click **Analyze** to run batch analysis using the selected settings.  
The software applies the analysis parameters used for the representative image to all the images in the image folder.  
When batch analysis is completed, the software saves the analysis results in a separate folder in the same location as the analyzed images.  
If **Review Annotated Images After Analysis** is selected, the software switches to the Review mode and displays the list of analyzed images in the Review panel.

---

**Note:** The analysis folder is named using the following format:

Batch <AnalysisDate><Unique Analysis ID>

For example, Batch 2021-01-19T114947

The images in the analysis folder retain their original name, but they are given the prefix AN\_.

---

# 7. Care and maintenance

---

## General care

- When cleaning optical elements, use only optical-grade materials to avoid scratching soft lens coatings.
- Use the appropriate cleaning solutions for each component, as indicated in the Decontamination Procedures below.
- If liquid spills on the instrument, turn off the power immediately and wipe dry.
- Do not exchange objectives between instruments unless you know that the components have been approved and recommended by Thermo Fisher Scientific.
- After using, cover the instrument with the supplied dust cover.

---

**Note:** Always use the correct power supply. The power adaptor specifications appear on the serial number label (front of LCD hinge) and in the Specifications. Damage due to an incompatible power adaptor is not covered by warranty.

---



**CAUTION!** Never disassemble or service the instrument yourself. Do not remove any covers or parts that require the use of a tool to obtain access to moving parts. Operators must be trained before being allowed to perform the hazardous operation. Unauthorized repairs may damage the instrument or alter its functionality, which may void your warranty. Contact your local EVOS™ distributor to arrange for service.

---

**IMPORTANT!** If you have any doubt about the compatibility of decontamination or cleaning agents with parts of the equipment or with material contained in it, contact Technical Support (page 247) or your local EVOS™ distributor for information.

---

## Objective lens care

Clean each objective periodically or when necessary with an optical-grade swab and a pre-moistened lens wipe (or lens paper moistened with lens cleaning solution). To avoid scratching the soft lens coatings, use only optical-grade cleaning materials and do not rub the lens.

---

**Note:** To protect all optical components of the instrument, use the dust cover when the instrument is not in use.

---

## Stage care

- Clean the X-Y stage as needed with paper towels or Kimwipes™ tissues dampened with 70% ethanol.
- Before moving the EVOS™ M7000 Imaging System to another location, use the Shipping Restraints to lock the X-Y stage to prevent the stage from sliding (page 112).

## Decontamination procedures

In case hazardous material is spilled onto or into the components of the EVOS™ M7000 Imaging System, follow the decontamination procedure as described below.

1. Turn power OFF.
2. Clean the LCD display.
  - a. Use a soft, dry, lint-free cloth to wipe off any dust from the screen.
  - b. Clean the LCD display with a non-alcohol-based cleaner made for flat-panel displays.

---

**IMPORTANT!** Do not spray cleaning fluid directly onto the screen, as it may drip into the display.

---

3. Lightly wipe working surfaces of the EVOS™ M7000 Imaging System (stage top, objective turret, housing, etc.) with paper towels or Kimwipes™ tissues dampened with 70% ethanol or 4,000 ppm hydrogen peroxide (H<sub>2</sub>O<sub>2</sub>).

---

**IMPORTANT!** Do not allow decontamination solution to get into lubricated areas, such as the stage roller bearings, or any points of rotation such as stage motors, condenser wheel, etc.

Do not soak any surface in decontamination solution.

NEVER spray liquid anywhere on the EVOS™ M7000 Imaging System.

Always wipe surfaces with dampened paper towels instead.

---



## Calibrate the stage

**Stage Calibration** establishes internal coordinates for the EVOS™ M7000 software to properly execute its functions. The procedure requires the EVOS™ Calibration Slide supplied with the instrument (also available separately; Cat. No. AMEP4720).

- Calibrate the stage
1. Go to **Settings** tab, then click **Stage Calibration**.

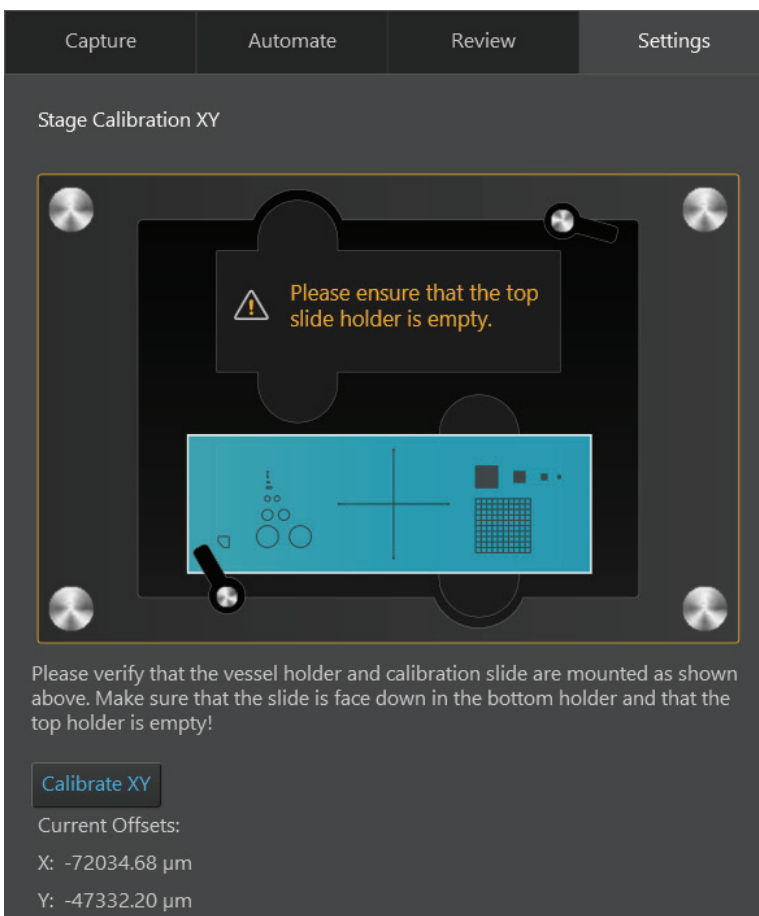

2. Mount the vessel holder and the calibration slide as shown on the screen, then click **Calibrate XY**.

As the instrument proceeds with the automated calibration procedure, the X-Y stage moves between pre-set coordinates and the progress of the calibration is shown on the screen.



- When the X-Y Stage Calibration is complete, click **Next** to proceed with Z Stage Calibration.

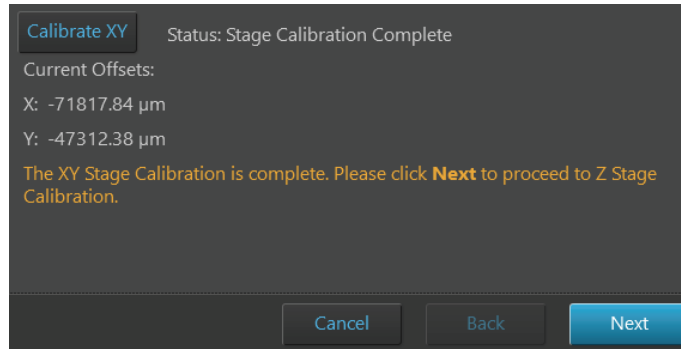

- Adjust the **Brightness** and **Focus** sliders to bring the image of the crosshairs into focus, then click **Done**.

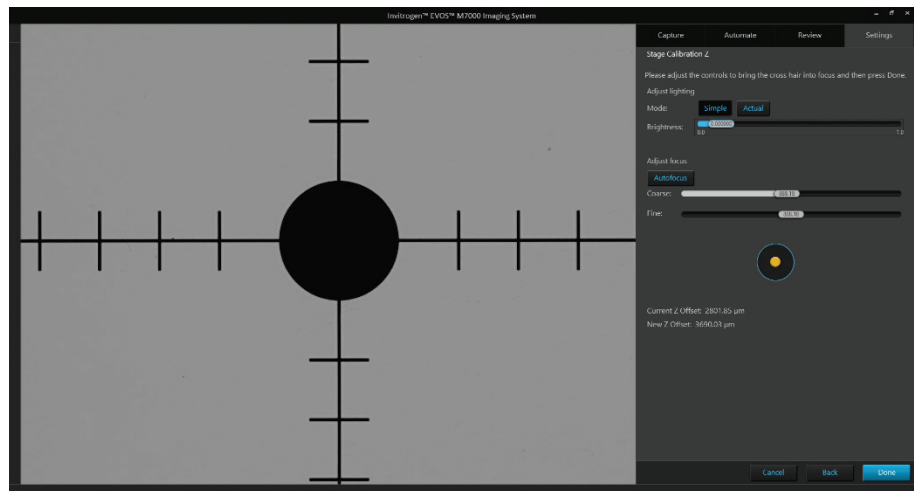
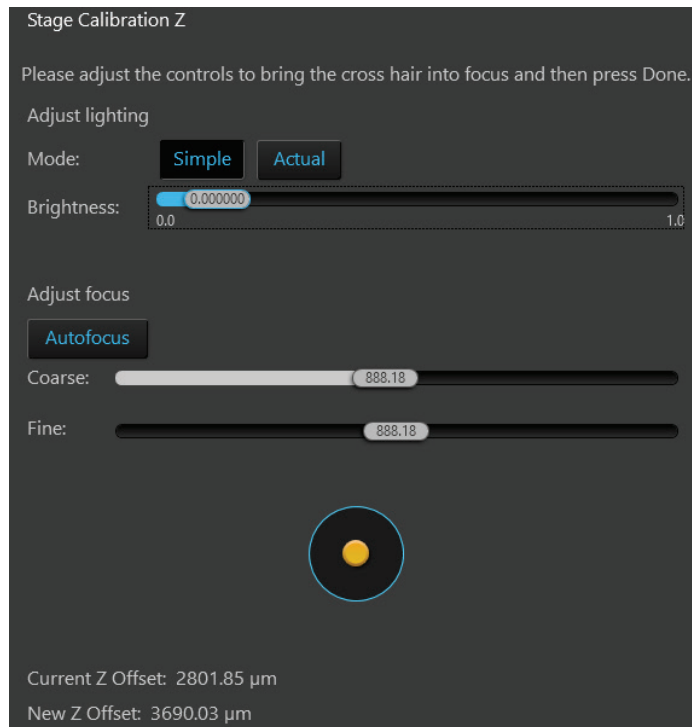

# Calibrate vessel

**Calibrate Vessel** function establishes the internal coordinates of the selected vessel, which allow the EVOS™ M7000 software to scan subsequent vessels of the same type accurately.

## Calibrate vessel

The following protocol describes the Vessel Calibration process for a generic 96-well plate as an example. The Vessel Calibration process follows a similar workflow for the calibration of other vessel types and the software provides on-screen instructions at each step.

1. Mount the vessel holder and the sample vessel on the X-Y stage.
2. Go to the **Settings** ▶ **Vessels** tab, then click the **Vessel** button to open the Vessel Selection dialog.
3. Select the **Vessel holder** and **Vessel type** that corresponds to your sample vessel, then click **Done**.

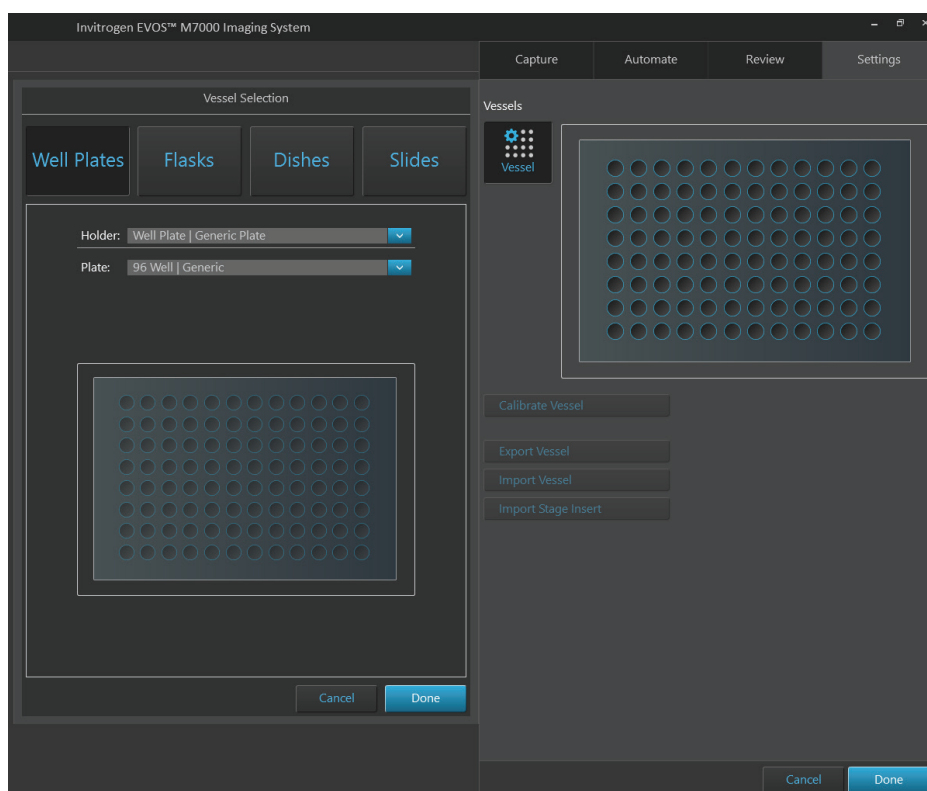
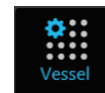

4. Click **Calibrate Vessel** to open the Vessel Calibration dialog.

**Calibrate Vessel**

The first screen of the dialog provides an overview of the Vessel Calibration process as well as options to cancel the calibration workflow or to restore the default calibration values.

---

**Note:** If you need to restore the calibration values of a vessel to the default settings, you can go to the first screen of the Vessel Calibration dialog and click **Restore Defaults**, which replaces any existing calibration settings with the factory default settings.

---

- Click **Next** to start the Vessel Calibration workflow.

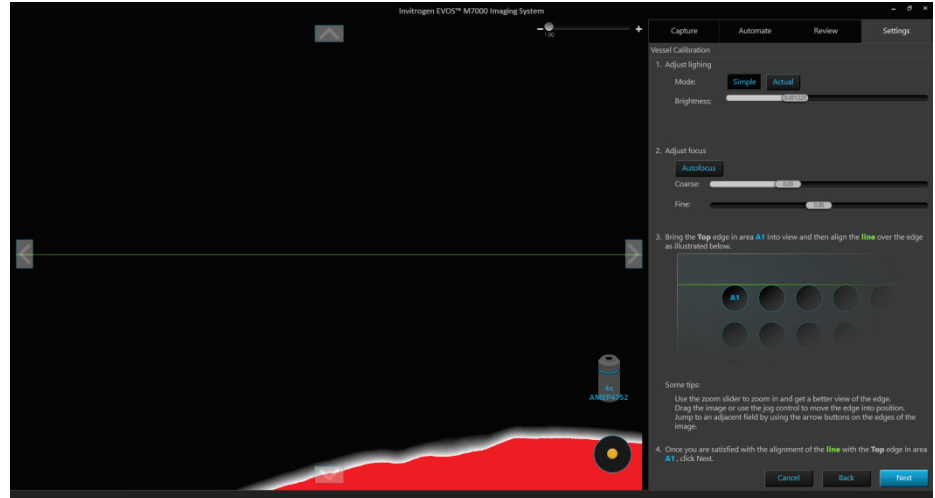

- Adjust **lighting** and **focus**.

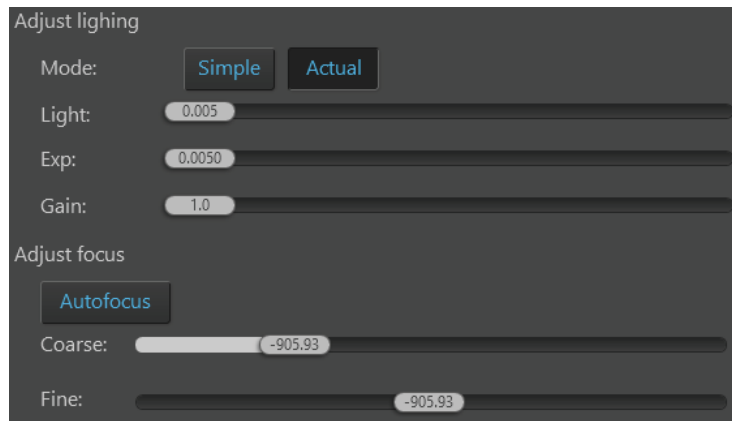

- Drag the image or use the **Jog control** to bring the **Top** edge of the **A1** well into view. If necessary, use the arrow buttons on the edges of the image to jump to an adjacent field.

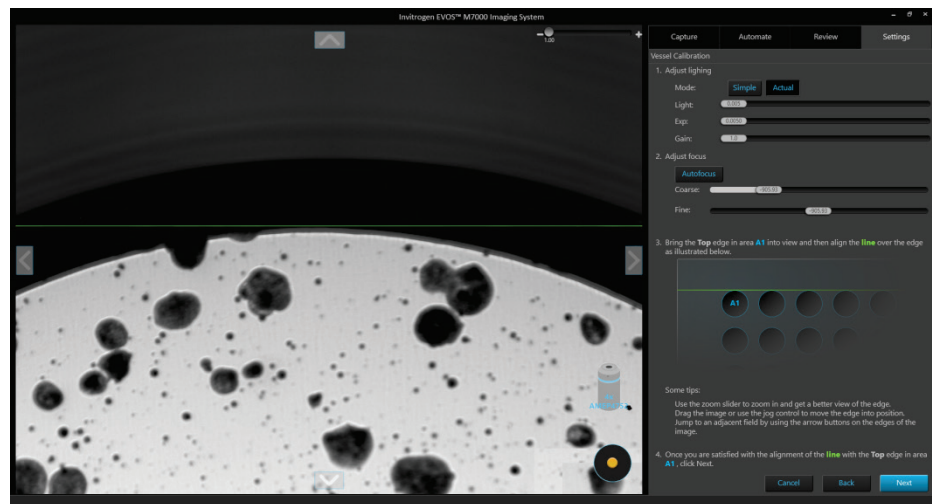

8. Drag the **green line** on the screen to align it with the **top edge** of the **A1 well**, as illustrated on the screen.  
If necessary, use the **Zoom** slider to zoom in and get a better view of the edge.



9. When you are satisfied with the alignment of the green line with the top edge of the A1 well, click **Next**.
10. Following on-screen instructions, repeat the alignment procedure for the **left**, **bottom**, and **right edges** of the **A1 well**, clicking **Next** after each alignment.
11. Following on-screen instructions, repeat the alignment procedure for the **right** and **bottom edges** of the **H12 well**, clicking **Next** after each alignment.

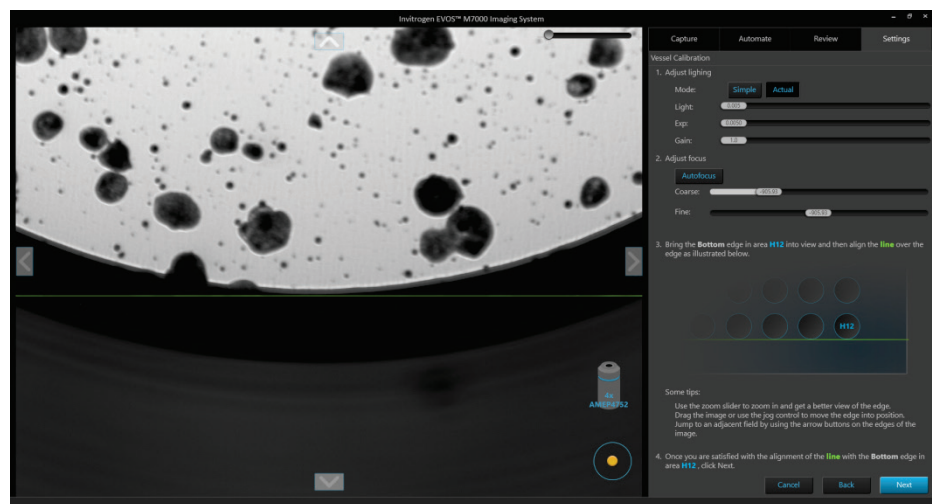
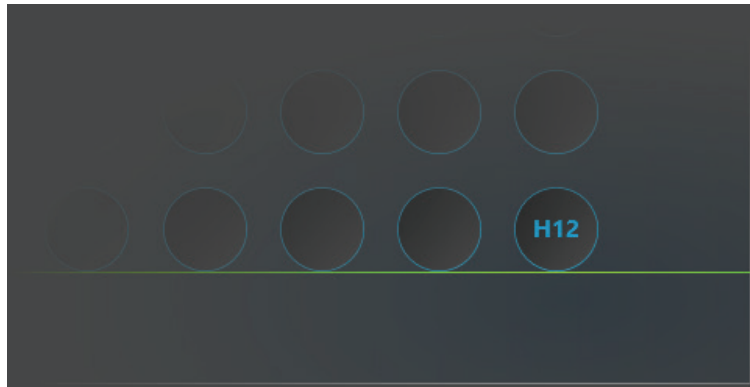

12. After you are done with the alignments, bring the sample in focus, then click **Next**.

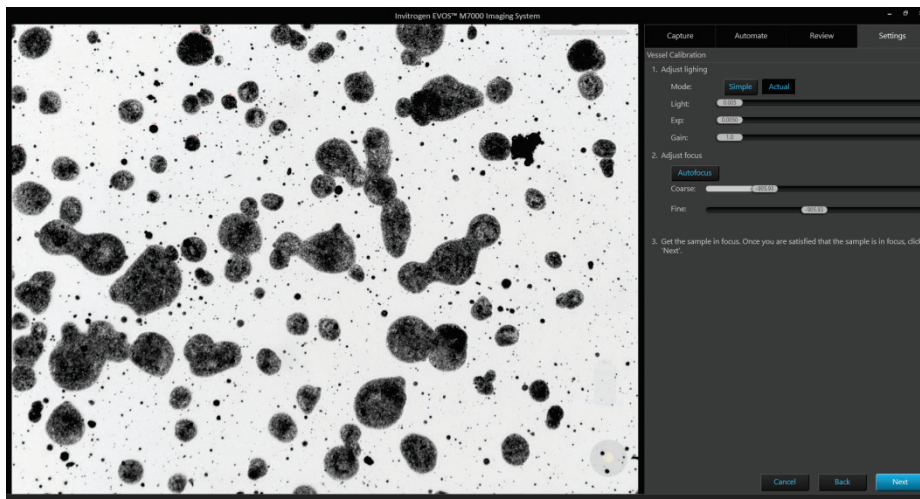

13. Review the images that show the alignment of the green line with the edges of the A1 and H12 wells.

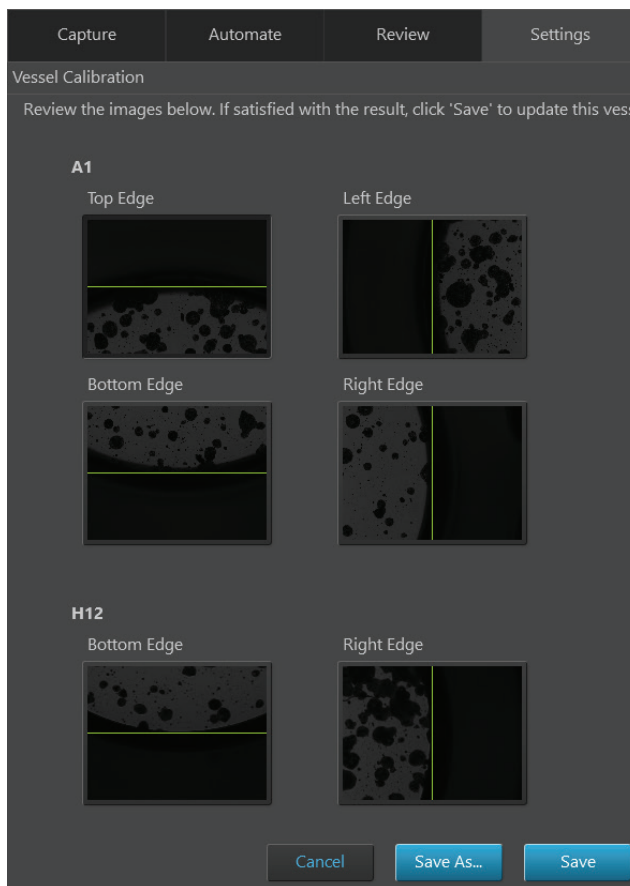

14. If satisfied with the results, click **Save** to update the existing vessel with the new calibration values.  
Alternatively, click **Save As** to save the vessel with the new calibration values as new vessel with a name of your choice.

## Change EVOS™ light cubes

You can add and remove EVOS™ light cubes to customize the EVOS™ M7000 Imaging System for your specific research needs. For a complete list of available light cubes and to inquire about custom light cubes, go to [thermofisher.com/evos](https://www.thermofisher.com/evos) or contact Technical Support (page 247).

### Change light cube

1. Remove the vessel holder from the X-Y stage.
2. On the **Settings** ▶ **Filter Cubes** tab, select the **Position** of the light cube you want to change, then click **Move to filter cube change position**.

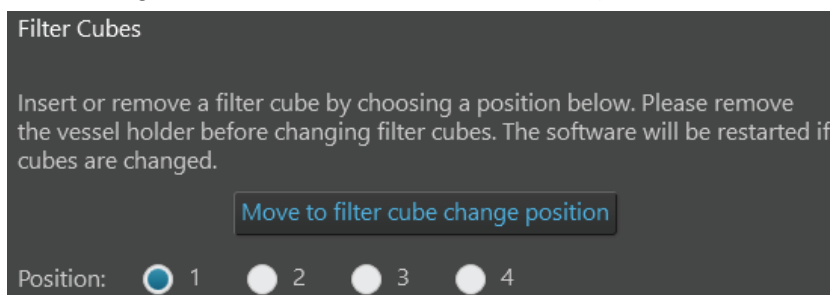

3. Use the light cube tool to loosen the two slotted screws (white arrows) that are flush with the ridges on the light cube.

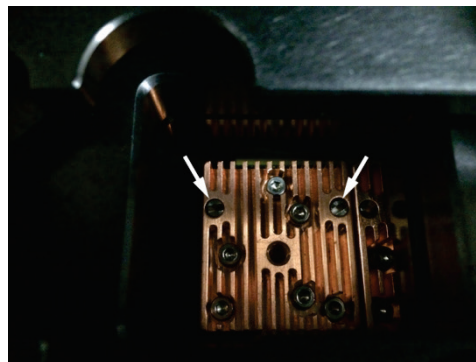

4. Screw the threaded end of the light cube tool into the hole in the center of the light cube (as shown).

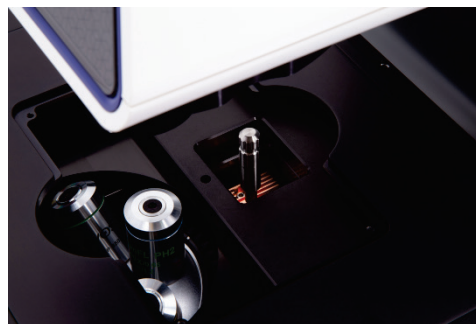

5. Use the light cube tool to tilt the light cube slightly toward you, then lift it out gently. Unscrew and remove the light cube tool from the light cube.
6. Attach the tool to the new light cube, then lower the light cube into position. Ensure that the electronic connections align properly (connections on the cube facing the back of the microscope) and the light cube sits squarely in place.
7. Use the light cube tool to tighten the two slotted screws so that the screw heads sit flush with the ridges on the light cube. Do not overtighten.

---

**IMPORTANT!** If the screws are not flush with the top of the light cube, they can catch on the stage while moving and damage the system.

---



## Change the objectives

You can add and remove objectives to customize the EVOS™ M7000 Imaging System for your specific research needs.

### Change objective

1. Remove the objective you want to replace from the objective turret. You may need to move the stage so that the objectives are accessible. Note the indicated position (1–5) of the removed objective on the turret (red arrow).



2. Screw the new objective into the open position in the objective turret. Note the part number of the objective and the turret position. In the following example, a new objective is installed into the turret position 5.



3. Go to the **Settings** ▶ **Objectives** tab, and find objective in the **Profiles** list on the left that matches the newly installed objective.

**Objectives**

To assign an objective profile, drag the profile from the list on the left to the turret position on the right.

**Profiles**

**Add** **Copy** **Edit**

Manufacturer	Part Number	Working Distance
Olympus	AMEP4734	0.77
<b>40x</b>		
Evos	AMEP4625	2.8
EVOS	AMEP4699	0.89
EVOS	AMEP4683	1.6
EVOS	AMEP4925	1.79
EVOS	AMEP4983	1.79
EVOS	AMEP4935	2.74
EVOS	AMEP4625	2.8
EVOS	AMEP4635	3.1
Olympus	AMEP4908	0.13
Olympus	AMEP4907	0.18
Olympus	AMEP4754	0.35
Olympus	AMEP4735	0.37

**Active**

Turret pos.

- 1 2 x Evos 5.1 ( AMEP4631 )
- 2 4 x Evos 16.9 ( AMEP4632 )
- 3 10 x Evos 8.4 ( AMEP4623 )
- 4 20 x EVOS 6.12 ( AMEP4982 )
- 5 40 x EVOS 3.1 ( AMEP4635 )

**Calibrate**



- Click and drag the **objective profile** for the new objective to the appropriate **turret position** on the right. In the following example, EVOS™ 40X objective with 2.8-mm working distance is selected and dragged to the turret position 5.

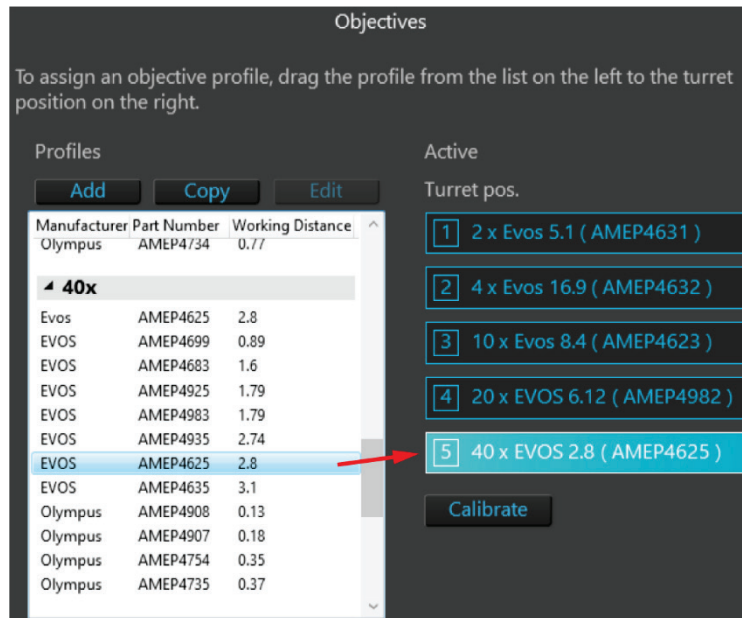

- Optional:* If desired, type in a label in the **Display Name** text box. This creates a label that is displayed on the Objective button in the Capture tab. In the following example, “LWD” is entered as the Display Name.

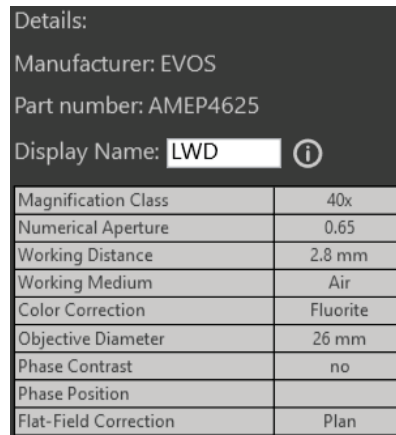

The Objective button in the Capture tab displays the label “LWD” below the objective magnification.



- When finished, click **Done** to return to the Settings tab.

---

**Note:** For best results, calibrate the newly installed objectives before using it in your experiments (page 114).

---

## Calibrate the objectives

**Calibrate Objective** is used to calibrate the field of view, parfocality, and parcentration parameters of the selected objective.

Parfocality ensures that the sample stays in focus when the objective is changed, and parcentration ensures that an object in the center of the field of view will stay in the center of the field no matter which objective is being used.

---

**Note:** The pre-installed objectives supplied with the EVOS™ M7000 Imaging System have been pre-calibrated. You do not need to calibrate them again unless they are reinstalled after removal from the instrument.

---

### Calibrate objective

Calibration procedure involves two distinct steps and requires the use of the EVOS™ M7000 calibration slide supplied with the EVOS™ M7000 Imaging System (also available separately; Cat. No. AMEP4720).

First, the calibration crosshair on the screen is matched to the crosshair on the calibration slide; then, the diameters of the reference circles on the calibration slide are measured. Total time required objective calibration is about 5 minutes.

---

**Note:** For best parfocality and parcentration, calibrate the installed objectives one after the other without removing the calibration slide.

---

1. Go to the **Settings** ▶ **Objectives** tab, then click **Calibrate** to launch the Objective Calibration tool.

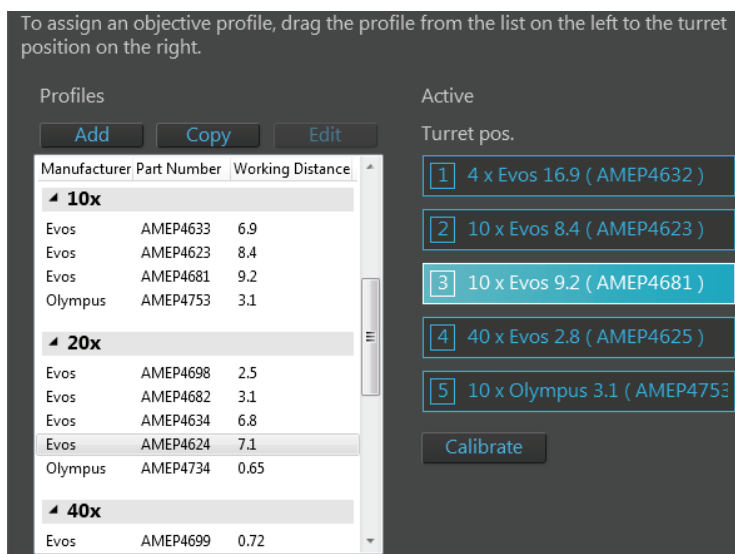
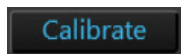

- Mount the EVOS™ Calibration Slide in the vessel holder as shown on the screen, select the objective you want to calibrate, then click **Calibrate Objective**.

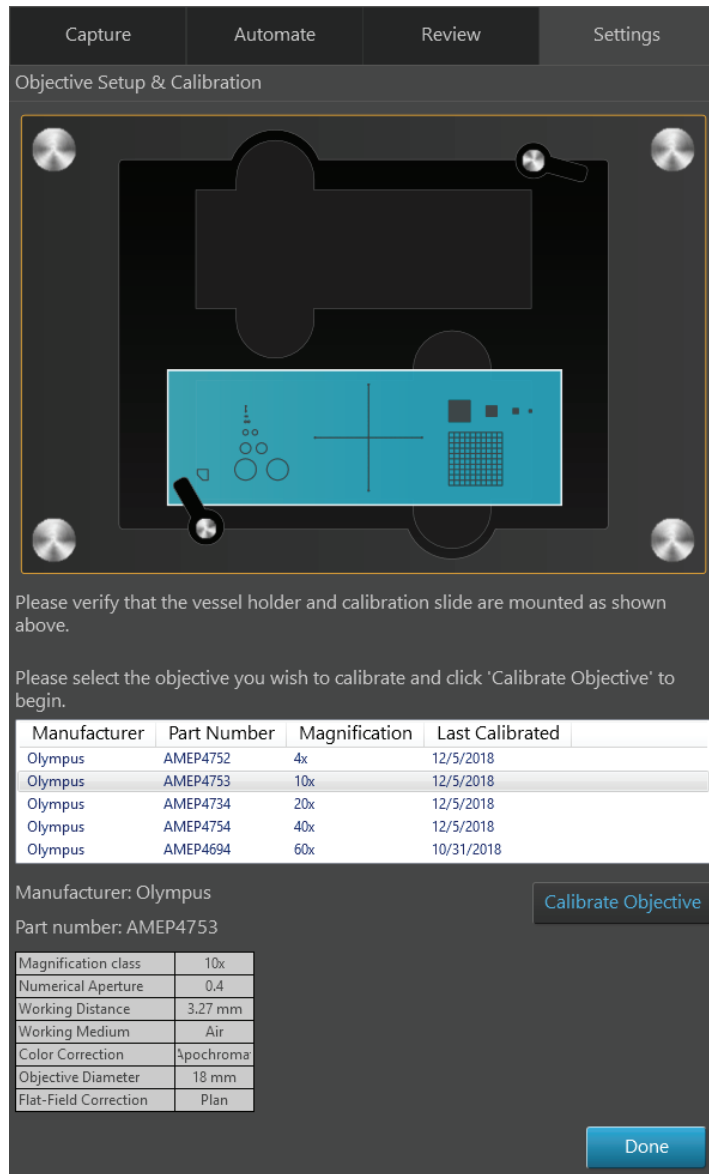

The stage moves to the calibration target and the instrument automatically finds the calibration crosshairs on the calibration slide (page 116).

---

**Note:** Depending on the type of objective being calibrated (e.g. Long Working Distance vs. Coverslip Corrected objective), the calibration slide needs to be mounted face up or face down. When mounting the slide, make sure to match the orientation of the slide to the graphic shown on the calibration screen.

---

3. Adjust the **Brightness** and **Focus**, then use the **Jog Control** button or click-drag the screen to bring the black crosshairs on the calibration slide into view.

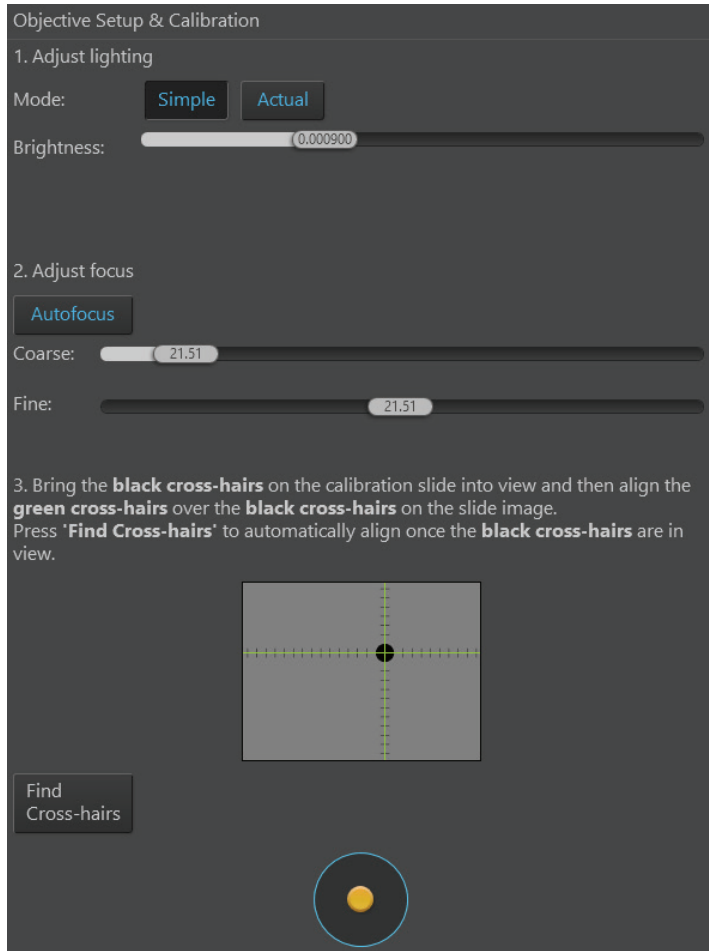

4. Manually align the green crosshairs over the black crosshairs or click **Find Crosshairs** to automatically align once the black crosshairs are in view.

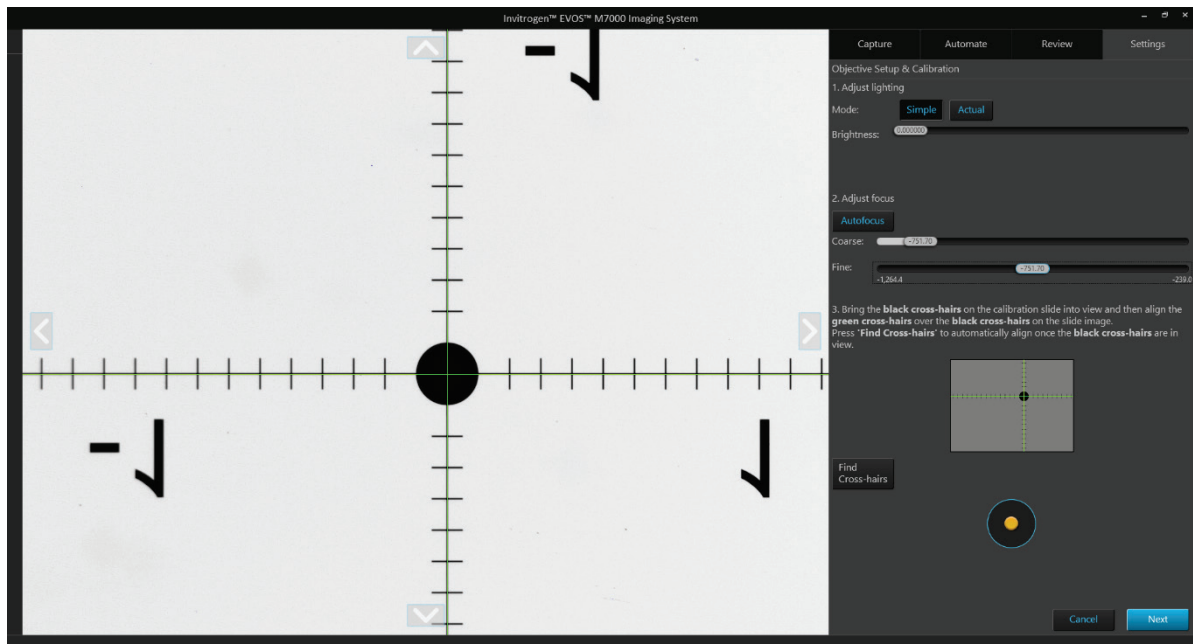

5. Click **Next** to proceed to the second part of the calibration procedure, measuring the diameter of the reference circle.

The stage automatically moves to the calibration circle and the software automatically selects the appropriate reference circle on the slide for the specific objective you are calibrating.

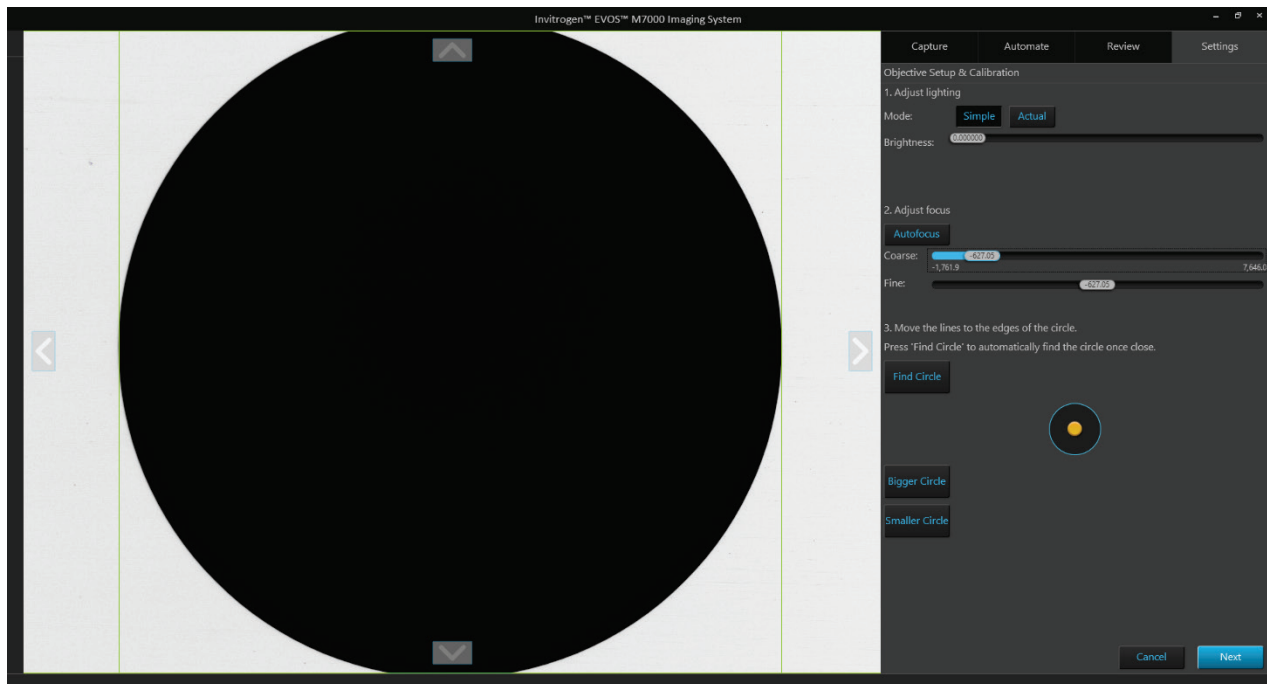

---

**Note:** If the circle on the screen is too large or too small, click **Smaller Circle** or **Bigger Circle** to move to an appropriately sized circle. For best results, use the largest circle possible.

---

6. Adjust the lighting and focus with the **Brightness** and **Focus** controls, then click **Find Circle** to move the green calibration lines to the edges of the reference circle. You can also manually move the lines by clicking and dragging them into position.
7. When finished, click **Next** to complete the calibration.
8. Repeat the calibration process for each additional objective to be calibrated, then click **Done**.

## Install the shipping restraints

Use the Shipping Restraints whenever you package the unit for shipment. If the unit is being hand-carried and is not at risk of drops or excessive vibration there is no need to install the restraint. If you need to remove light cubes or objectives, remember to do so before installation of the Shipping Restraint.

### Install procedure

1. Go to **Settings ▶ Service** tab, then click **Move to Shipping Position**.
2. Turn off the power to the instrument (but not to the computer), then proceed to securing the restraints in the locations shown.

Move to Shipping Position

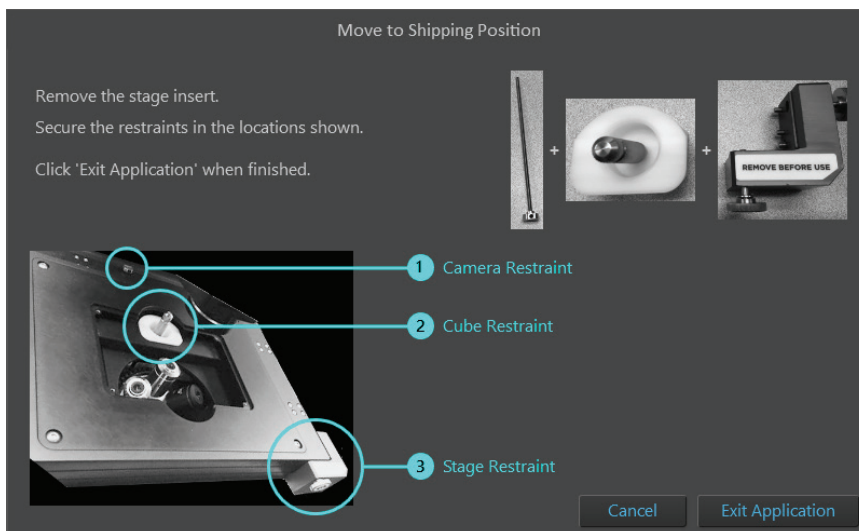

3. To install the **X-Y Stage Shipping Restraint**, attach to threaded holes in the front right corner of stage, then tighten the screws in order from bottom to top, 1-2-3.

If necessary, you can gently push on the side or front of the stage to move the plates into alignment.



---

**IMPORTANT!** Do not over-tighten the screws. Once the lock washer compresses, stop tightening.

---

4. To install the **Light Cube Shipping Restraint**, place the white Light Cube Shipping restraint into the Light Cube access hole, then insert the Light Cube Tool into the hole in the shipping restraint. Secure the restraint by screwing the Light Cube Tool into the top of the Light Cube.



---

**IMPORTANT!** Do **not** over-tighten. The Light Cube Tool is secure when it moves with the Light Cube. The Light Cube should still be able to move slightly side to side with respect to the X-Y Stage.

---

5. To install the **Camera Shipping Restraint**, insert the Camera Shipping Restraint into the hole at the back of the X-Y Stage, then screw it into the camera carriage until the red knob touches the top of the X-Y Stage. Do **not** over-tighten.

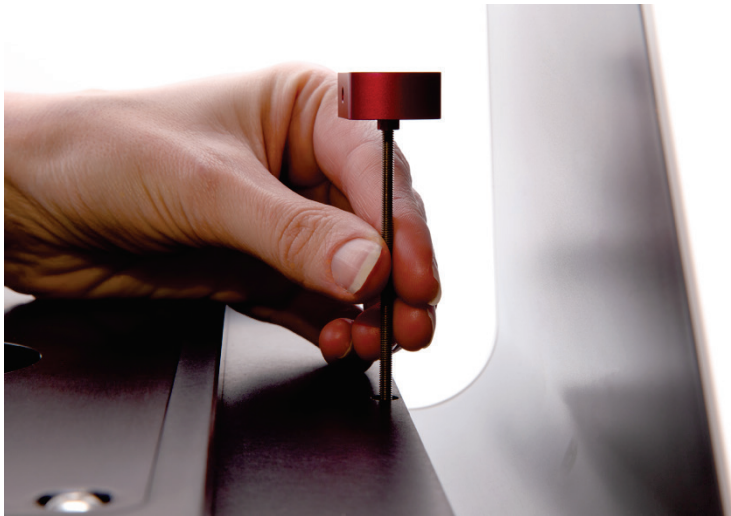

6. After securing all restraints, click **Exit Application**, then turn off the power to the computer.

---

**IMPORTANT!** Do **not** power the instrument back on until the Shipping Restraints have been removed.

---



# Appendix A: Troubleshooting

**Note:** For additional technical support, contact your local EVOS™ distributor. If you do not have your distributor information, visit [thermofisher.com/evos](http://thermofisher.com/evos) or contact Technical Support (page 247).

## Image quality issues

Problem	Possible solutions
Image is too dim (at higher magnifications)	Remove condenser slider, if one is in place.
Specks, dots, or blurs on image	Follow instructions under “Objective lens care” (page 103) to clean objectives.
Uneven focus across screen	<ul style="list-style-type: none"><li>• Position sample, so that it lies flat on the stage; ensure that the sample’s thickness is even.</li><li>• Be sure vessel holder is mounted flat with respect to stage.</li></ul>
Difficulty focusing on coverslipped sample on standard slide	Place the slide so the coverslip is facing up (long working-distance objectives require a thick optical substrate, and image best through 1.0–1.5 mm of glass or plastic).
Image display is black	<ul style="list-style-type: none"><li>• Click the Power button (onscreen).</li><li>• Center sample over objective.</li><li>• Verify power supply is connected and power switch is on.</li></ul>
Image display is red, or red patches cover parts of the screen	<ul style="list-style-type: none"><li>• Dim the illumination until the red highlights disappear to get the maximum level of brightness without any overexposed areas.</li><li>• Disable the “Show saturated pixels” option in the <b>Settings</b> ▶ <b>General</b> tab.</li></ul>



## Software interface issues

---

**Note:** We recommend keeping the EVOS™ M7000 Imaging System up to date with the latest software.

---

Problem	Possible solutions
Image does not respond to changes in focus or stage position	Click the <b>Light</b> button to return to live observation.
Some of the software controls are not available	The controls available on the EVOS™ M7000 Imaging System are contextual; only the controls relevant for the chosen task will be available.
Save button does not respond when clicked	Click capture first; it is only possible to save an image that is captured.
Unable to connect to network	<ul style="list-style-type: none"><li>• Verify physical cable connections; confirm the Ethernet jack is active.</li><li>• Contact your network administrator to resolve any network issues.</li></ul>

## Mechanical issues

Problem	Possible solutions
Automatic stage does not move	Remove shipping restraint.
Filter Cube Axis does not move	Remove shipping restraint.
Camera Axis does not move	Remove shipping restraint.
Vessel does not sit securely on moving stage	Use the correct vessel holder for the application (visit <a href="http://thermofisher.com/evos">thermofisher.com/evos</a> ).

## Appendix B: System overview

---

### Technical specifications

---

**Note:** Technical specifications of the EVOS™ M7000 Imaging System are subject to change without notice. For the latest product information, see the product page ([thermofisher.com/evosm7000](http://thermofisher.com/evosm7000)).

---

<b>Physical characteristics</b>	<p><b>Dimensions (L × W × H):</b> 45.7 × 33.0 × 35.6 cm (18 × 14 × 13 inches)</p> <p><b>Weight:</b> 16 kg (35 lb)</p> <p><b>Footprint:</b> Approximately 92 cm × 92 cm (36 in × 36 in); entire system includes the instrument, computer, and 23-inch touchscreen, high-resolution LCD monitor</p> <p><b>Operating temperature:</b> 4°–32°C (40°–90°F)</p> <p><b>Operating humidity:</b> &lt;90%, non-condensing</p> <p><b>Operating power:</b> 100–240 VAC, 1.8 A</p> <p><b>Frequency:</b> 50–60 Hz</p> <p><b>Electrical input:</b> 24 VDC, 5 A</p>
<b>Hardware</b>	<p><b>Optics:</b> Infinity-corrected optical system; Royal Microscopical Society (RMS)-threaded objectives with 45 mm parfocal distance</p> <p><b>Imaging mode:</b> Fluorescence, brightfield, color brightfield, and phase contrast</p> <p><b>Imaging methods:</b> Single color, multicolor, area scan with tiled or stitched images, time lapse, z-stacking, movie capture</p> <p><b>Illumination:</b> Adjustable intensity LED (&gt;50,000-hour life per light cube)</p> <p><b>Light cubes</b> (not included): 5 position chamber for 4 fluorescence light cubes plus brightfield imaging; light cubes with integrated hard-coated filter set; broad selection standard and specialty light cubes (page 124)</p> <p><b>Contrast methods:</b> Fluorescence and transmitted light (brightfield &amp; phase contrast)</p> <p><b>Objective turret:</b> 5-position; front-mounted control</p> <p><b>Objectives</b> (not included): Wide selection of high-quality long working distance (LWD) and coverslip-corrected objectives</p> <p><b>Condenser:</b> 60 mm LWD condenser; 4 position turret with a clear aperture and 3 phase annuli</p> <p><b>Stage:</b> Motorized X-Y scanning stage; 120 mm × 80 mm travel range with sub-micron resolution; drop-in inserts to receive vessel holders and lockdown holders to fix sample in place during long scans</p> <p><b>Focus mechanism:</b> Automated focus mechanism with sub-micron resolution</p> <p><b>LCD display:</b> 23-inch high-resolution touchscreen color monitor (also fully controllable via mouse); 1920 × 1080 pixel resolution</p> <p><b>Cameras:</b> High-sensitivity 3.2 MP (2048 × 1536 pixels) monochrome CMOS sensor with 3.45 μm pixel resolution; high-sensitivity 3.2 MP (2048 × 1536 pixels) color CMOS sensor with 3.45 μm pixel resolution</p> <p><b>Captured images:</b> 16-bit Raw monochrome: TIFF, PNG; 8-bit per RGB channel: TIFF, PNG, or JPG; movies and time-lapse images: AVI or WMV</p>

**Computer:** External Dell™ PC with an Intel™ Core™ i7-8700 processor, 32 GB DDR4 RAM, 512 GB PCIe solid-state drive, NVIDIA™ Quadro™ P1000 graphics card with 4 GB memory, and Windows™ 10 software, designed to operate with touchscreen monitor and microscope

**Output ports:** Instrument: USB 3.1 Type B, 4-pin power port;  
Computer: 1 × USB 3.1 Gen 2 Type C; 5 × USB 3.1 Gen 1 Type A;  
4 × USB 2.0 Type A; 1 serial; 2 × DisplayPort 1.2; 1 RJ45; 2 PS/2; 1 UAJ; 1 line-out

**Networking capability:** Connection through Windows/SMB network via an Ethernet cable connection

**Power supply:** AC adapter with country-specific power cords.

## Operation principles and technical overview

**LED illumination** The EVOS™ M7000 Imaging System utilizes an adjustable intensity LED light source provided by the proprietary, user-interchangeable LED light cube (see below). Because the LED light source is as close as possible to the objective turret, the number of optical elements in the channel is minimized. High-intensity illumination over a short channel increases the efficiency of fluorophore excitation, providing better detection of weak fluorescent signals.

In contrast to traditional fluorescence microscopy light sources that use mercury, a toxic carcinogen requiring special handling and disposal, the LED light source of the EVOS™ M7000 Imaging System is more environmentally friendly, energy efficient, and has a significantly longer life span (>50,000 hours versus 300 hours for a typical mercury bulb and 1,500 hours for a metal halide bulb).

**LED light cubes** Each user-interchangeable, auto-configured light cube contains an LED, collimating optics, and filters. In addition to the channel dedicated to the transmitted light from the condenser for brightfield contrast applications, the EVOS™ M7000 Imaging System can accommodate up to five fluorescent or specialty light cubes for multiple-fluorescence research applications.

The table below lists some of the common fluorescent and specialty light cubes available from Thermo Fisher Scientific. For a complete list of available light cubes and to inquire about custom light cubes, go to [thermofisher.com/evos](http://thermofisher.com/evos) or contact Technical Support (page 247).

Light cube	Dye
DAPI	DAPI, Hoechst™, BFP
TagBFP	TagBFP
CFP	ECFP, Lucifer Yellow, Evans Blue
GFP	GFP, Alexa Fluor™ 488, SYBR™ Green, FITC
YFP	EYFP, acridine orange + DNA
RFP	RFP, Alexa Fluor™ 546, Alexa Fluor™ 555, Alexa Fluor™ 568, Cy™3, MitoTracker™ Orange, Rhodamine Red, DsRed
Texas Red	Texas Red™, Alexa Fluor™ 568, Alexa Fluor™ 594, MitoTracker™ Red, mCherry, Cy™3.5
Cy5	Cy™5, Alexa Fluor™ 647, Alexa Fluor™ 660, DRAQ5™
Cy5.5	Cy™5.5, Alexa Fluor™ 660, Alexa Fluor™ 680, Alexa Fluor™ 700
Cy7	Cy™7, IRDye 800CW
CFP-YFP em	CFP/YFP (for FRET applications)
A0	Acridine orange + RNA, simultaneous green/red with FL color
White	Refracted light applications

## Image capture and save formats

### Raw vs. Displayed images

**Raw images** contain minimally processed data from the image sensor. The purpose of raw image formats is to save, with minimum loss of information, data obtained from the sensor, and the conditions surrounding the capturing of the image (the metadata). As such, it is the recommended format for image analysis and quantitation. EVOS™ M7000 Imaging System can save images captured in different channels individually as 16-bit Raw images.

Available **File format** for viewing Raw image outputs in EVOS™ M7000 Imaging System are **TIFF, PNG, C01, and DIB**. The changes made on a Raw image file to produce the viewable output are non-destructive; that is, only the metadata that controls the rendering is changed to make different output versions, leaving the original data unchanged.

**Displayed images** are captured images that are saved in a format that can be viewed in most image display applications. Displayed images give the best (“prettiest”) results, especially when producing tiled and stitched images, but result in loss of information when the data from the image sensor is rendered to produce the viewable image.

We recommend saving captured images as both Raw and Displayed images to preserve the option of using the Raw images in downstream image analysis and quantitation, and the Displayed images for instances where “prettier” images are required, such as publications, presentations, etc.

### Tiled, Stitched, and Merged images

If an object extends into multiple fields, a set of multiple images from the fields into which the object extends may be required to show the object of interest in full.

**Tiled images** are images captured from multiple fields in an area and lined-up close together into a tiled format, thus giving you a single image that includes images from all the fields in the selected area.

When you use the **Tiled image** option without enabling **Stitching**, the images are simply placed very close together with a barely noticeable seam to create an image of all fields in that area. Tiling is quicker than stitching and is often sufficient.

If you notice that images from adjacent fields are not lining up correctly, you will want to ensure that your instrument is fully calibrated and the camera is aligned.

**Stitched images** are images captured from multiple fields in an area and lined up with a slight overlap into a tiled format. **Stitching** uses an algorithm to apply the overlap, then removes the seam so you can visualize objects that cross fields. Stitching option is available under Scan Area of Automate tab.

If you are analyzing images that cross fields (such as images of neurites), and the images are slightly misaligned, you might want to consider **Stitching** the images.

**Merged image** is an image generated by combining the images captured in different channels into a multicolor overlay. It is also referred to as a composite image.

## Appendix C: Graphical user interface (GUI)

The EVOS™ M7000 Imaging System is controlled by the integrated Invitrogen™ EVOS™ M7000 Software through a graphical user interface (GUI), which is accessed by the touchscreen monitor or the computer mouse and keyboard.

### GUI layout

The GUI of the EVOS™ M7000 Imaging System consists of the Viewing area on the left and a series of tabs representing the main functions of the software (Capture, Automate, Review, and Settings) on the right. Each tab contains the controls necessary to execute the selected function. The Locations button, Area View/Field View toggle, and the Zoom slider are located above the Viewing area, which can contain additional controls depending on the view mode and the tab selected.

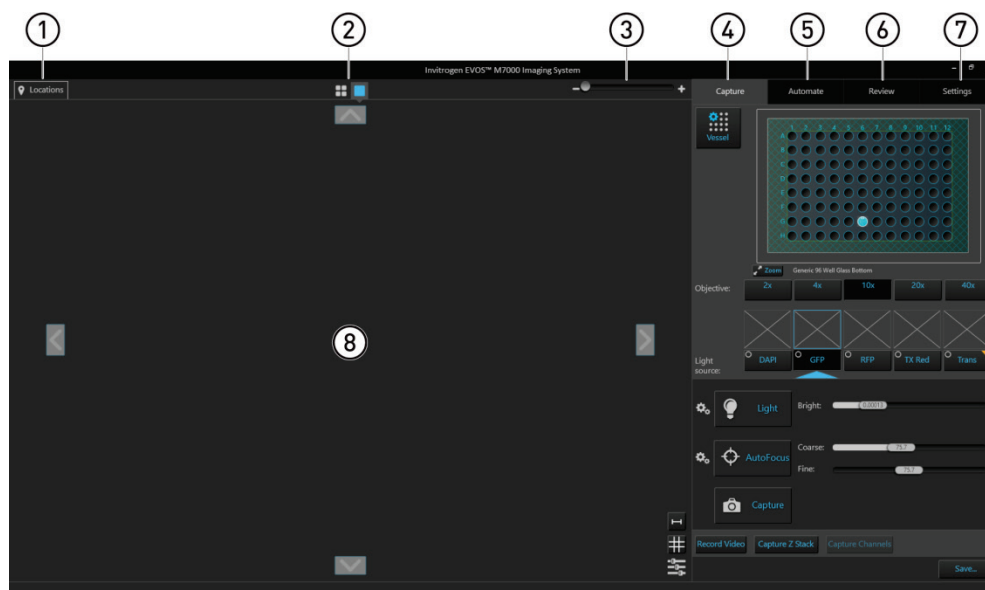

- ① **Locations:** Opens the Location tools, which allow you to select locations or designate capture fields for automated scan protocols (page 134).
- ② **Area View/Field View toggle:** Switches between Area View and Field View.
- ③ **Zoom slider:** Zooms in and out of the Viewing area.
- ④ **Capture tab:** Contains the controls for the manual capture of images (page 139).
- ⑤ **Automate tab:** Used to create and run automated scan protocols (page 157).
- ⑥ **Review tab:** Allows you to review captured images (page 192).
- ⑦ **Settings tab:** Contains controls to select and adjust basic and advanced system options and instrument functions (page 196).
- ⑧ **Viewing area:** Displays the sample in Area View or Field View mode (page 127).

**Note:** Click on the **View Help Content** icon to open the Help window, which provides EVOS™ M7000 Imaging System Help.

Position your pointer over the **Tooltip** icon without clicking it to view a small Position box with additional information.



## Viewing area

**Overview** Viewing area displays the sample in **Area View** or **Field View**. The Area View/Field View toggle and the Zoom slider are located above the Viewing area.

**Area View** In Area View, the Viewing area displays a graphical representation (i.e., map) of the selected target area in its entirety. Depending on the vessel in use, the target area may represent a single well of a multiwell plate, a chamber of chamber slide, or an entire culture dish.

Area View allows you to select individual fields of view for manual image capture.

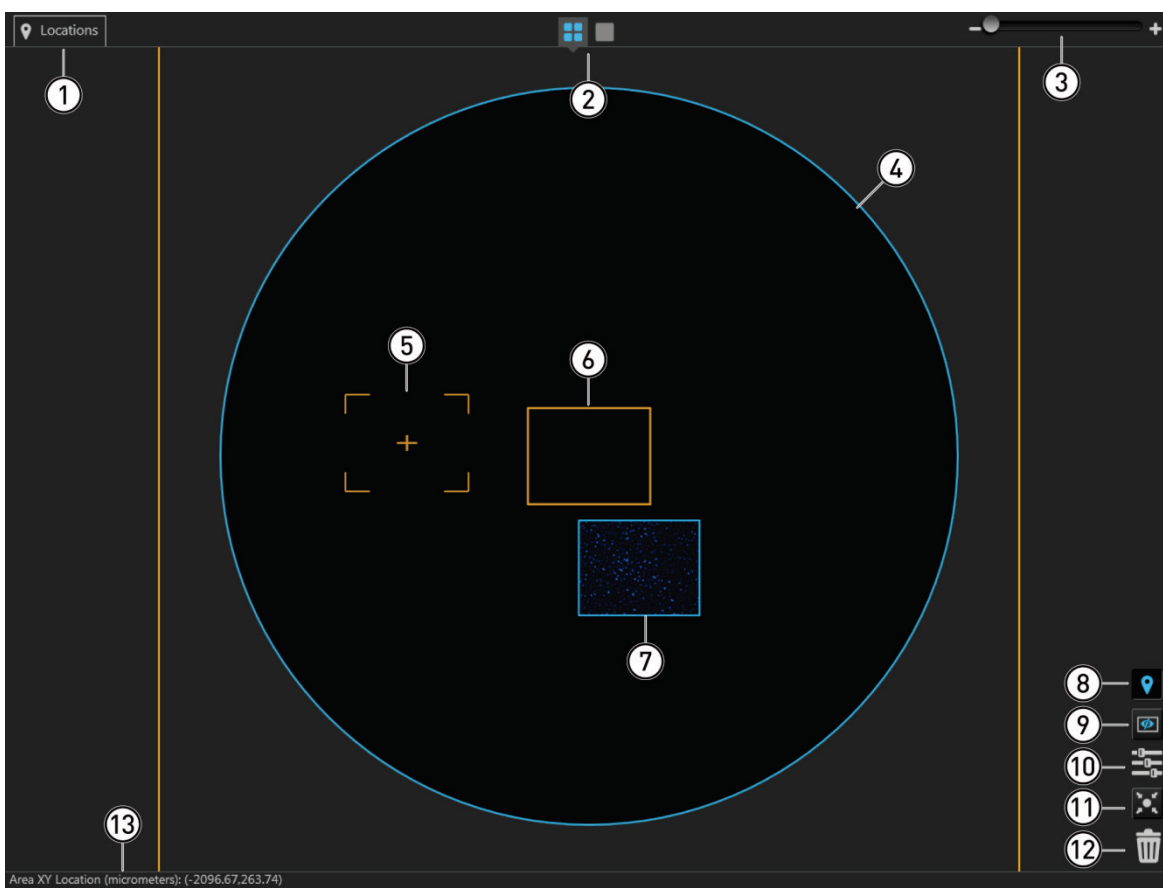

- |   |  |
|---|--|
| ① <b>Locations</b> (page 134)                   | ⑧ <b>Toggle locations display</b> (page 129)   |
| ② <b>Area View/Field View toggle</b> (page 128) | ⑨ <b>Toggle field borders</b> (page 129)       |
| ③ <b>Zoom slider</b> (page 128)                 | ⑩ <b>Image display settings</b> (page 129)     |
| ④ <b>Area map</b> (page 128)                    | ⑪ <b>Center on selected field</b> (page 130)   |
| ⑤ <b>Field selection tool</b> (page 128)        | ⑫ <b>Delete image options</b> (page 130)       |
| ⑥ <b>Selected field</b> (page 129)              | ⑬ <b>Area and pixel information</b> (page 130) |
| ⑦ <b>Captured field</b> (page 129)              |  |



## Area View controls

- ① **Locations button:** Opens the Locations tools, which allow you to mark (“pin”) specific points or draw fields of interest in the Viewing area, which can be revisited for further examination or captured during automated scan protocols.



Note that the Location tools accessed from the Area View differ from those that are accessed through the Field View.

For detailed description of the Locations function, see page 134.

- ② **Area View/Field View toggle:** Switches between Area View and Field View.



- ③ **Zoom slider:** Zooms in and out of the Viewing area.



The minimum and maximum zoom for Area View are 1X and 2X, respectively.

- ④ **Area map:** Represents the current sample area selected for view or capture (i.e., target area). The target area is selected using the **Vessel map** (page 141).

**Note:** If using a single culture dish, flask, or slide, the scan area corresponds to the entire dish, flask, or slide. As such, the scan area displayed in Area View represents the entire dish or flask selected.

In a multi-well plate, multi-chamber slide, or multiple dishes on multi-dish holders, each scan area corresponds to a single well, chamber, or dish.

The following examples show the area map of a single well of a 96-well plate (left) and a sample slide on a double-slide holder (right). The orange square in each example corresponds to a single field view at 4X magnification and illustrate the relative size of a single well in a 96-well plate and a sample slide.

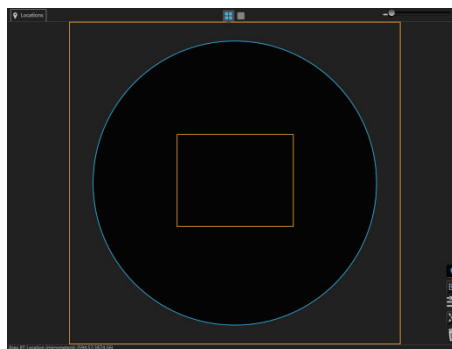

Area map – Single well of a 96-well plate

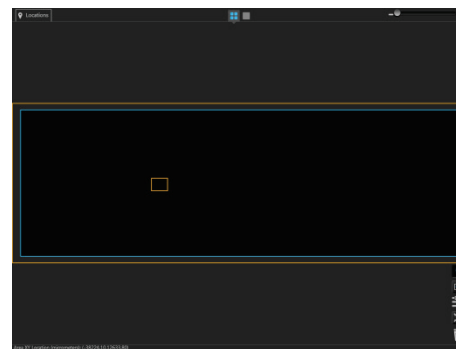

Area map – Sample slide

- ⑤ **Field selection tool:** Selects the target field you want to capture.
- The selection tool consists of an orange crosshair within a broken orange rectangle. The crosshair indicates the position of the objective lens over the target and the rectangle represents the actual imaging area.



- The relative size of the field selection tool depends on the zoom level and the selected objective.

- ⑥ **Selected field:** Field that has been selected. Selected field corresponds to the field of view displayed in the **Field View**.
- Selected field, whether captured or not, is indicated by orange borders around it, which cannot be turned off.
  - Clicking the **Capture** button (page 148) captures an image of the selected field and stores it in the memory buffer.



- ⑦ **Captured field:** Field that has been captured. A thumbnail of the captured image is displayed within the field borders.
- If multiple images are captured for the same field in different channels, the captured images are displayed as an overlay.

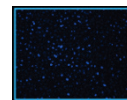

- ⑧ **Toggle locations display:** Switches the display of locations (defined with the Location tools) in Area View on and off.



Locations display is on



Locations display is off

- ⑨ **Toggle field borders:** Switches the display of the borders around captured fields in Area View on and off. This option is not available in Field View.



Field borders are on



Field borders are off

- When field borders are turned on, all captured fields in Area View are displayed with blue borders around them.
- Currently selected field, whether captured or not, is displayed with an orange border, which cannot be hidden.

- ⑩ **Image display settings:** Opens the Image display settings window, which allows you to adjust image display parameters (brightness, contrast, gamma) for the Viewing Area. Clicking the button again closes the window.

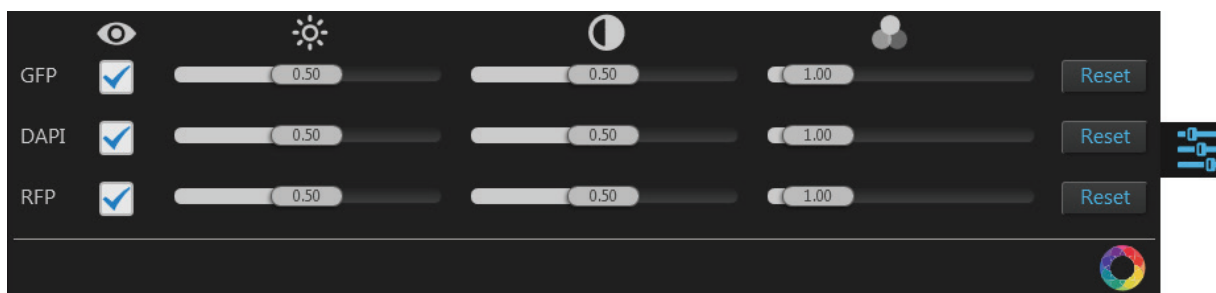





**Note:** Adjustments made to Image display settings only affect how the image is displayed in the Viewing Area; they do not affect how the image is captured.

- Visible Channels:** Visible channels  are the channels selected for display in the Viewing area. They are selected using the **Toggle channel display** checkbox located on the top left corner of the corresponding **Light source** button (page 143).

**Note:** The controls for image display settings are contextual; only the controls for the visible channels will be available. In the example above, only the controls for the GFP, DAPI, and RFP channels are displayed.

- To remove a channel from display, uncheck the corresponding **Visible Channel**  checkbox. To display it again, recheck the checkbox.

- **Brightness** , **Contrast** , and **Gamma**  parameters for each of the selected channels are adjusted using the corresponding sliders.
- **Toggle image color display:** Option to display images in pseudocolor or in grayscale in the Viewing area. By default, color display is on. 

When on, images are displayed in default pseudocolor corresponding to the channel in which they were captured. You can change the default pseudocolor using in the **Settings ▶ Filter Cubes** tab (page 192).

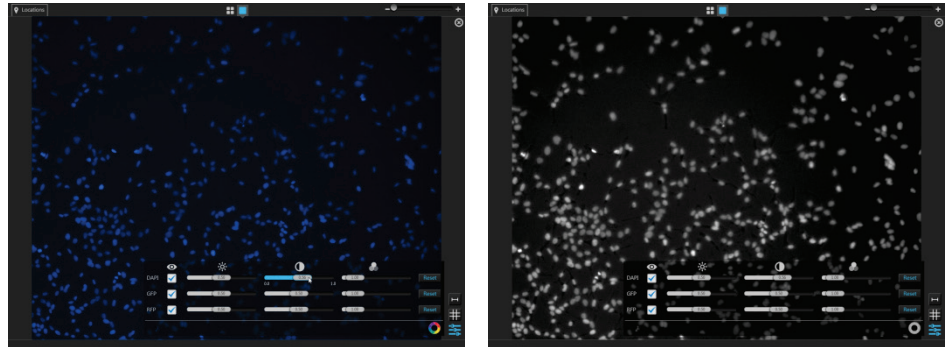

When off, images are displayed in grayscale.



Color display is on



Color display is off

- ⑪ **Center on selected field:** Centers the Viewing area on the selected field. 
- ⑫ **Delete image options:** Opens the Delete image options window, which contains the controls listed below. Clicking the button again closes the window. 

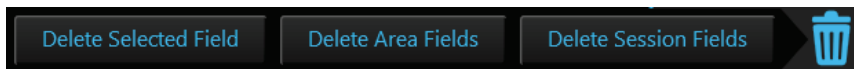

- **Delete Selected Field:** Deletes only the selected field, if the selected field contains a captured image. If the selected field is empty, this option is not available.
- **Delete Area Fields:** Deletes only the fields that were captured in the current scan area. Images captured in other areas are not deleted.
- **Delete Session Fields:** Deletes all fields in all areas that were captured in the current session.
- ⑬ **Area and pixel information:** Displays the coordinates of the pointer and pixel intensity at the pointer location.

Area XY Location (Microns): (-389.57,475.19) Pixel XY Offset: (80, 80) Z Locations: (N/A, -3538.33, N/A, N/A, N/A) Pixel Intensities: (N/A, 341, N/A, N/A, N/A)

- **Area XY Location (Microns):** Location of your pointer in relation to the center of the selected well along the x-y axis, expressed in  $\mu\text{m}$ .
- **Pixel XY Offset:** Location of your pointer in relation to the top left corner of the captured field, expressed in pixels along the x-y axis.
- **Z Locations:** Location of the captured plane along the z-axis, in  $\mu\text{m}$ .
- **Pixel Intensities:** Pixel intensity at the pointer location as reported by the camera. It represents the number of photons detected by the camera sensor.
- Area XY Location at the pointer location is displayed for the entire scan area. Pixel XY Offsets, Z Locations, and Pixel Intensities are displayed only for captured fields.

## Field View

Field View displays the currently selected field in the Viewing area. It allows you to preview the sample and to adjust imaging parameters (e.g., brightness, focus) in the Live mode before capture.

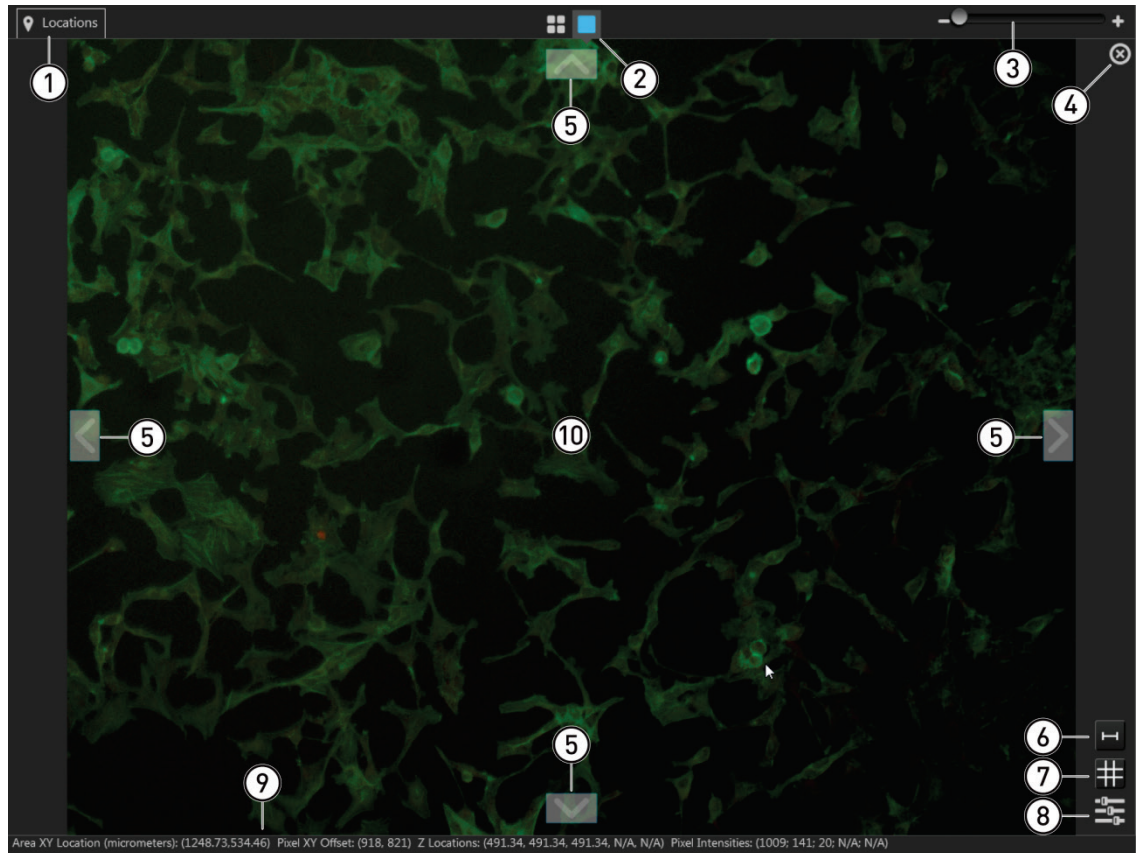

- If the selected field contains a captured image and the display is turned on for the channel in which the image was captured, Field View displays the captured image, allowing you to preview it before saving.
- If the field was captured in multiple channels, Field View displays an overlay of the captured images.





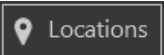

- |  |   |
|--|---|
| ① Locations (page 134)                   | ⑥ Toggle scale bar (page 132)           |
| ② Area View/Field View toggle (page 132) | ⑦ Toggle sample grid (page 132)         |
| ③ Zoom slider (page 132)                 | ⑧ Image display settings (page 132)     |
| ④ Delete field (page 132)                | ⑨ Area and pixel information (page 133) |
| ⑤ Navigation arrows (page 132)           | ⑩ Selected field of view (page 133)     |



## Field View controls

- ① **Locations button:** Opens the Locations tool, which allows you to mark (“pin”) specific points in Field View. 

The pinned points can be revisited later or used in a automated scan protocol. Note that the Location tools accessed from the Field View differ from those that are available through the Area View. For detailed description of the Locations function, see page 134.
- ② **Area View/Field View toggle:** Switches between Area View and Field View. 
- ③ **Zoom slider:** Zooms in and out of the Viewing area. 

The minimum and maximum zoom for Field View are 1X and 4X, respectively.
- ④ **Delete field:** Deletes the image captured in the current field on view. This button is available only if there is an image captured in the current field on view. 
- ⑤ **Navigation arrows:** Moves the stage exactly one field of view in the corresponding direction (**up, down, left, right**). 
- ⑥ **Toggle scale bar:** Switches the display of the scale bar in the Viewing area on and off.

 Scale bar display is on       Scale bar display is off
- ⑦ **Toggle sample grid:** Switches the display of the sample grid in the Viewing area on and off.

 Sample grid display is on       Sample grid display is off
- ⑧ **Image display settings:** Opens the Image display settings window, which allows you to adjust image display parameters (brightness, contrast, gamma) for the Viewing Area. Clicking the button again closes the window. 

For more information on Image display settings window, see page 129.

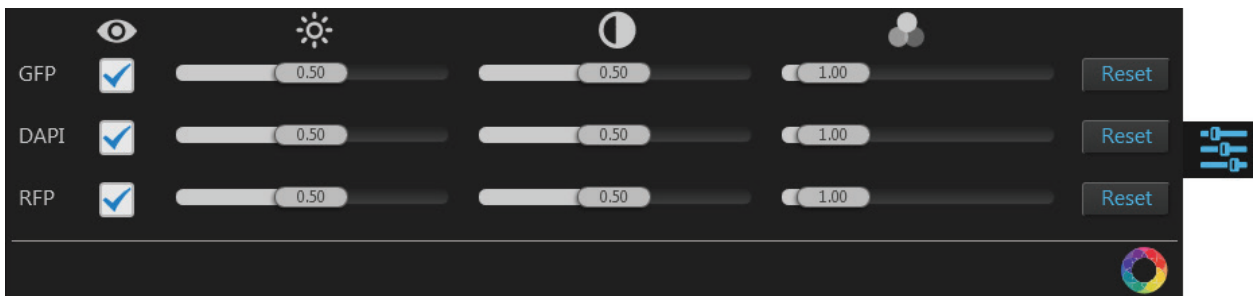



- ⑨ **Area and pixel information:** Displays the coordinates of the pointer and pixel intensity at the pointer location.

Area XY Location (Microns): (96.34,1215.38) Pixel XY Offset: (638, 930) Pixel Intensity: (424)

This information is displayed only if the Light is on for the selected channel, or if the current field of view contains a captured image and image display is on for the channel in which the image was captured.

- **Area XY Location (Microns):** Location of your pointer in relation to the center of the selected well along the x-y axis, expressed in  $\mu\text{m}$ .
- **Pixel XY Offset:** Location of your pointer in relation to the top left corner of the captured field, expressed in pixels along the x-y axis.
- **Z Locations:** Location of the captured plane along the z-axis, in  $\mu\text{m}$ .
- **Pixel Intensities:** Pixel intensity at the pointer location as reported by the camera. This represents the number of photons detected by the camera sensor.

- ⑩ **Selected field of view:** Displays the entire selected field of view.

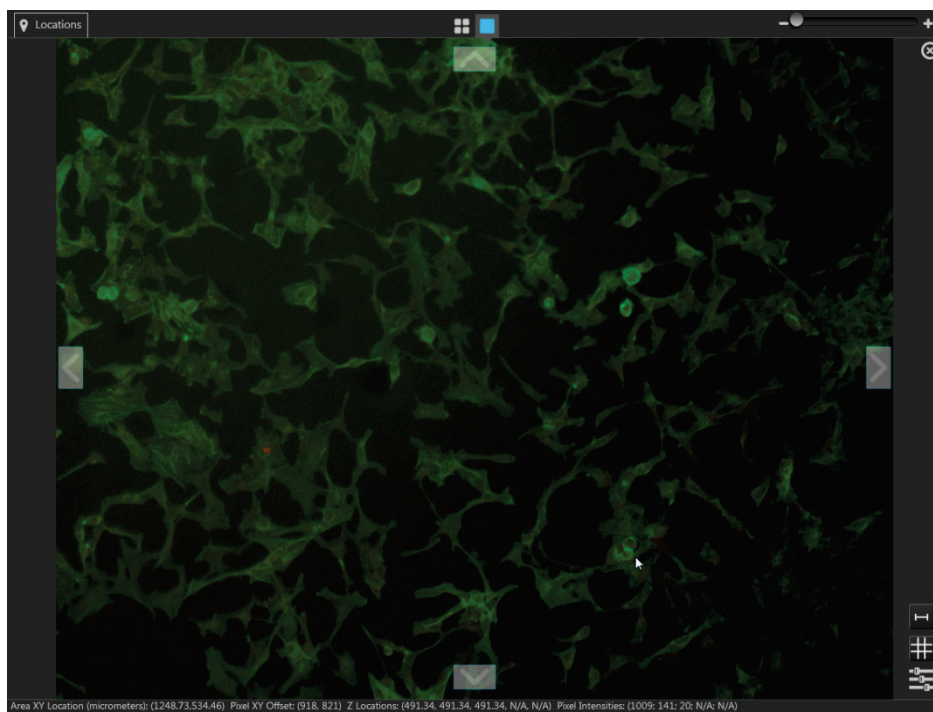

- If a previously captured field is selected in Area View, Field View displays the image captured in the selected field.
- If the selected field is captured in multiple channels, Field View displays an overlay of the captured images.
- Switching the Field View to **Live mode** (i.e., **Light** button on) displays the live image of the selected field in the current channel, whether the field contains a captured image or not.
- Switching the **Live mode** off (i.e., **Light** button off) returns the Field View to its previous state (blank or displaying the previously captured image).

## Locations

Locations function allows you to mark (“pin”) specific points or draw fields of interest in the Viewing area. These locations of interest can then be revisited for further examination or captured during automated scan protocols.

Note that the Location tools are contextual; the tools available depend on whether the instrument is in Field View or Area View.

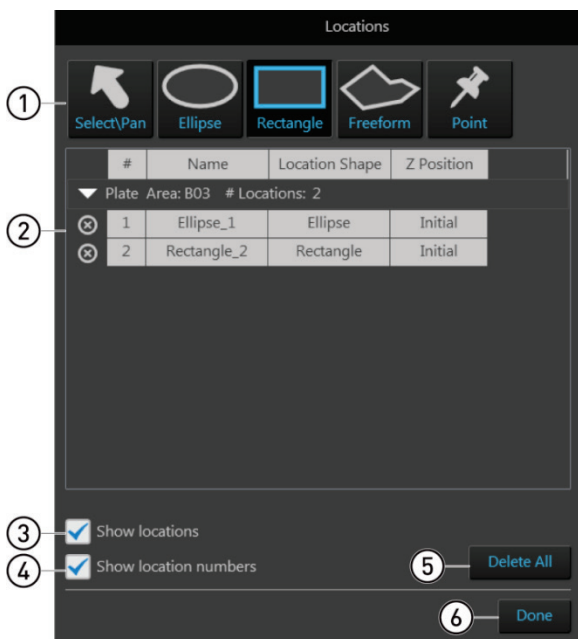

Locations – Area View

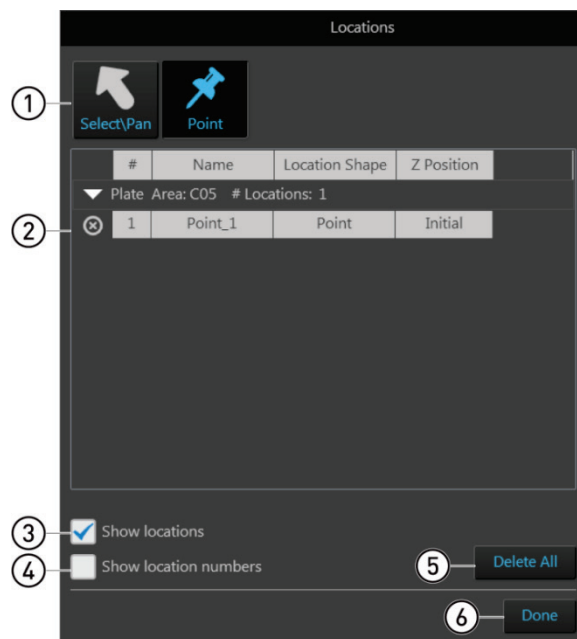

Locations – Field View

- ① Location tools (page 135)
- ② Locations directory (page 137)
- ③ Show locations (page 138)
- ④ Show location numbers (page 138)
- ⑤ Delete all (page 138)
- ⑥ Done (page 138)

## Locations controls

① **Location tools:** Used to define points and fields of interest.



Location tools – Area View

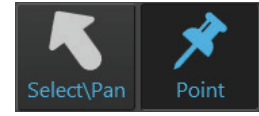

Location tools – Field View

- **Select\Pan:** Allows you to explore different regions of the sample vessel in the Viewing area when the Locations controls are active.

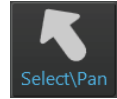

To navigate to a different region in the Viewing area, select **Select\Pan**, then click-drag the Viewing area in the desired direction.

- **Ellipse:** Allows you to define a field group that best fits an ellipse drawn in Area View.



To define the capture region, select **Ellipse**, then click-drag an ellipse shape in Area View.

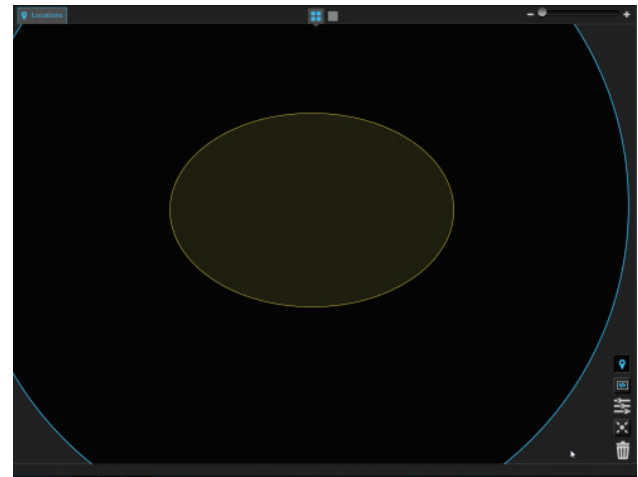
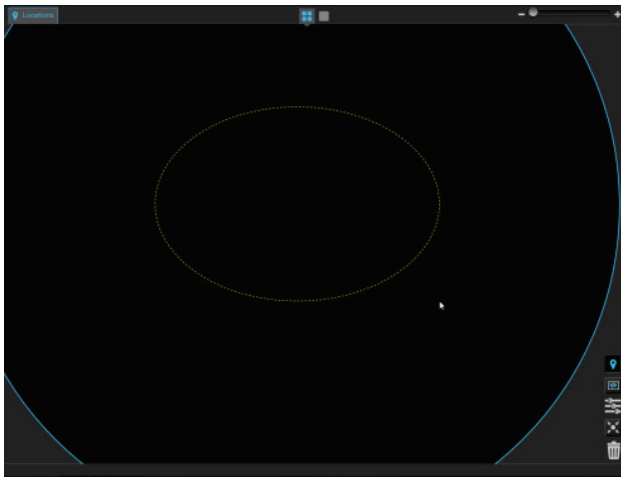

- **Rectangle:** Allows you to define a field group that best fits a rectangle drawn in Area View.



To define the capture region, select **Rectangle**, then click-drag a rectangle shape in Area View.

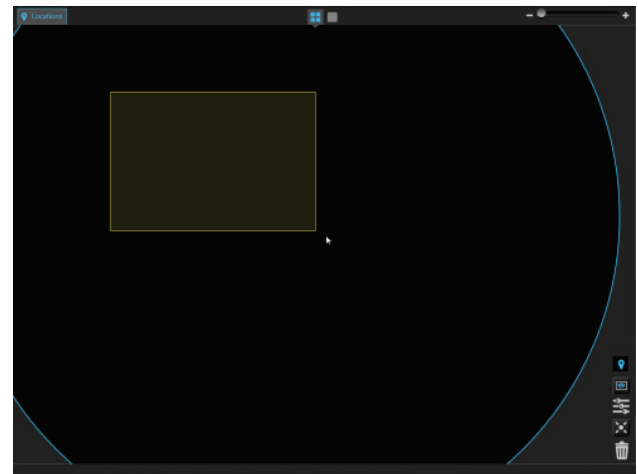
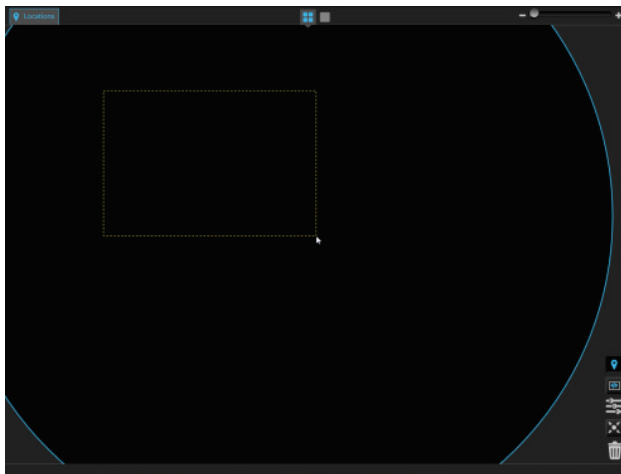



- **Freeform:** Allows you to draw a freeform shape based on straight-sided polygonal shapes in Area View that will encompass the capture fields.



To define the freeform region, select **Freeform**, then click on the desired location in Area View to add your first anchor point.

At the next location, click again to add your second anchor point. When you release the mouse button, both points will be joined by a straight line.

Continue moving around the Area View, clicking to add new anchor points and fastening the end of the line to each new point as you go.

To close your freeform shape, double-click on your initial anchor point. Alternatively, double-click anywhere on Area View to close your freeform shape with a straight line from this point to your initial starting point.

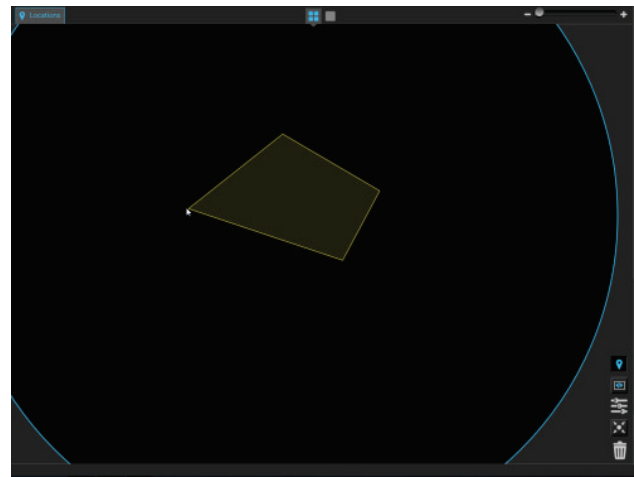
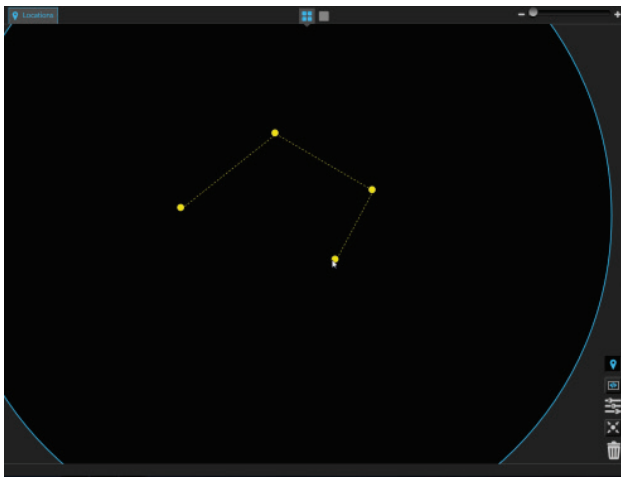

- **Point:** Allows you to mark (“pin”) specific points in Area and Field Views as locations of interest.

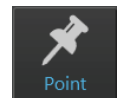

To mark a point in Area or Field View, select **Point**, then click on the desired location.

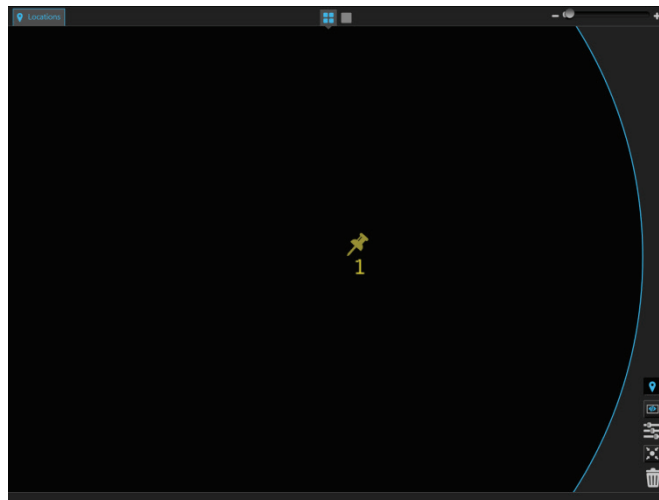

- ② **Locations directory:** Lists the locations (points or shapes) created with the Location tools in a table format. You can select a location from the directory to view the sample and/or set the z-focus at that location.

In the following example, the directory lists three locations created in the first well (Area: A01) of a 96-well plate: an ellipse, a rectangle, and a point.

#	Name	Location Shape	Z Position
▼ Plate Area: A01 # Locations: 3			
1	Ellipse_1	Ellipse	Initial
2	Rectangle_2	Rectangle	Initial
3	Point_3	Point	Initial

- To select a location, click the desired location from the list. The X-Y axis stage moves to align the objective with the selected (“current”) location. In the example below, location number 3 (“Point\_3”) is selected in the Locations directory and the objective is centered on that location (as indicated by the orange rectangle showing the field of view).

#	Name	Location Shape	Z Position
▼ Plate Area: A01 # Locations: 3			
1	Ellipse_1	Ellipse	Initial
2	Rectangle_2	Rectangle	Initial
3	Point_3	Point	Initial

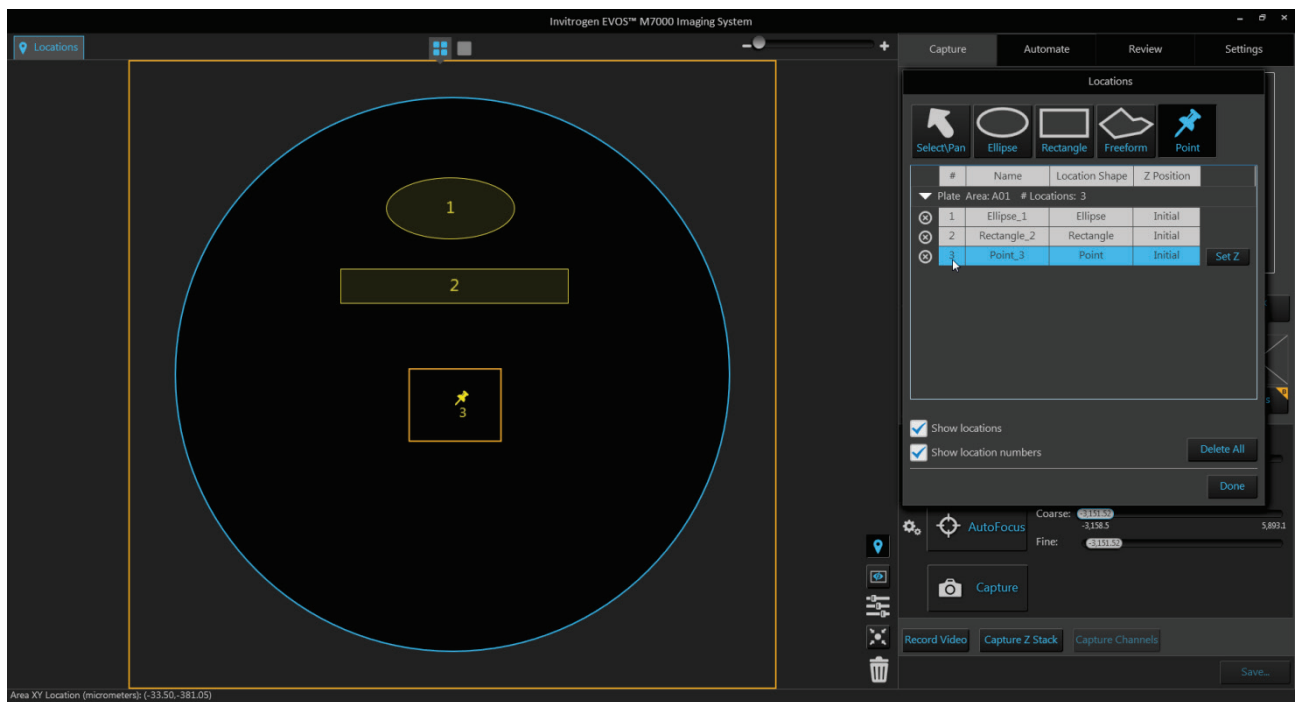

- To set the z-focus for a location, select the location from the list, then click **Set Z**. The z-focus will be set at the current z-position for that location.

#	Name	Location Shape	Z Position	
▼ Plate Area: A01 # Locations: 3				
⊗ 1	Ellipse_1	Ellipse	Initial	Set Z
⊗ 2	Rectangle_2	Rectangle	Initial	
⊗ 3	Point_3	Point	Initial	

- To change the z-position at a selected location, exit the Locations tool and adjust the focus using the **focus sliders** in the Capture tab, then **Set Z** for that location as described.
- To remove a location from the list, select the location, then click the **Delete Location** button. 

#	Name	Location Shape	Z Position	
▼ Plate Area: A01 # Locations: 4				
⊗ 1	Ellipse_1	Ellipse	Initial	Set Z
⊗ 2	Rectangle_2	Rectangle	Initial	
⊗ 3	Point_3	Point	Initial	
⊗ 4	Point_4	Point	Initial	

Delete Location

- ③ **Show locations:** Toggles the display of existing locations in the Viewing area.

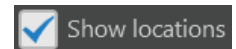

- ④ **Show location numbers:** Toggles the display of location numbers for the existing locations in the Viewing area.

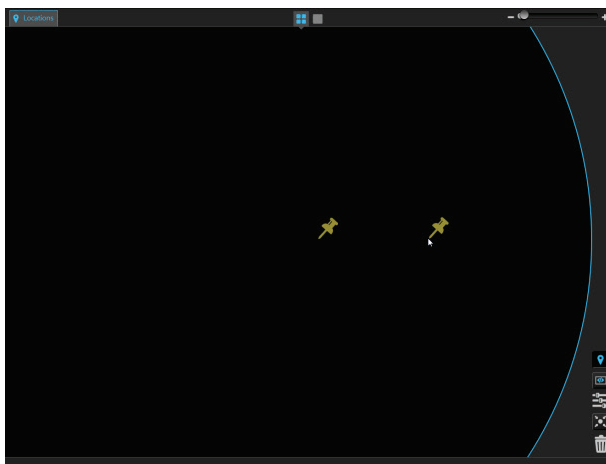
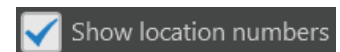

- ⑤ **Delete all:** Deletes all locations in the Locations directory and removes them from the Viewing area..
- ⑥ **Done:** Finalizes the location creation procedure and returns to the Capture tab.

# Capture tab

## Overview

Capture tab contains the controls for the manual capture of images. You can access the **Automate**, **Review**, and **Settings** at any time by selecting the corresponding tab. All current selections and settings within the Capture tab are preserved if you navigate away from the Capture tab.

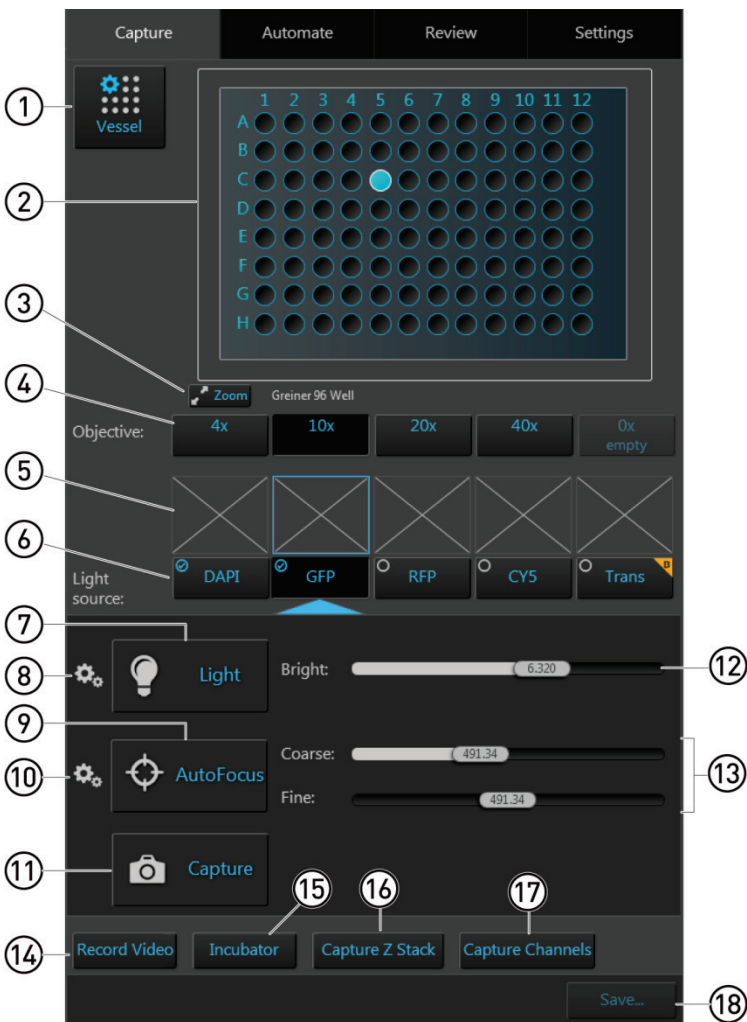

- ① Vessel (page 140)
- ② Vessel map (page 141)
- ③ Zoom (page 142)
- ④ Objective (page 142)
- ⑤ Thumbnail images (page 142)
- ⑥ Light source (Channel) (page 143)
- ⑦ Light (Live mode) (page 143)
- ⑧ Brightness and camera settings (page 144)
- ⑨ AutoFocus (page 145)
- ⑩ Advanced focus settings (page 146)
- ⑪ Capture (page 148)
- ⑫ Brightness controls (page 149)
- ⑬ Focus sliders (page 150)
- ⑭ Record Video (page 150)
- ⑮ Incubator (page 151)
- ⑯ Capture Z Stack (page 152)
- ⑰ Capture Channels (page 154)
- ⑱ Save (page 154)

## Capture tab controls

- 1 **Vessel:** Opens the Vessel Selection dialog, which allows you to specify the vessel and vessel holder in use. You **MUST** select a vessel prior to imaging.

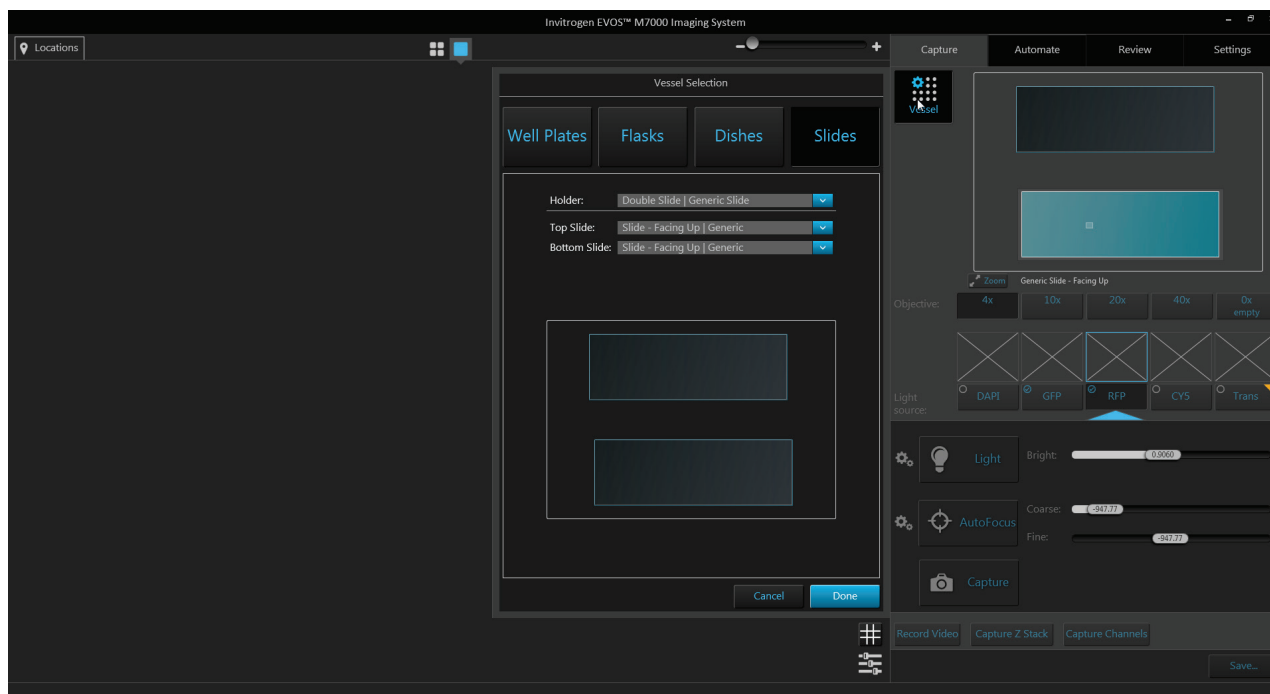
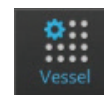

- Select the **Vessel category** that corresponds to your sample vessel to display the holder and vessel type selections available for that category. Available vessel categories are **Well Plates**, **Flasks**, **Dishes**, and **Slides**.

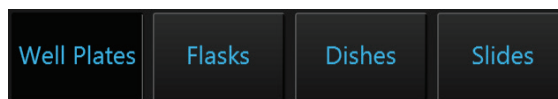

The following images are example screens from the Vessel Selection dialog for each of the vessel categories.

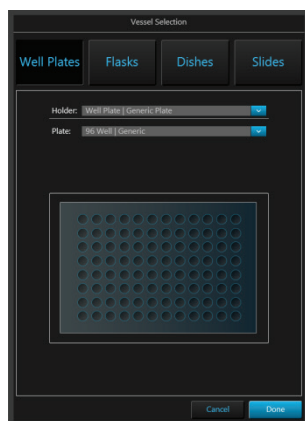

Well Plates

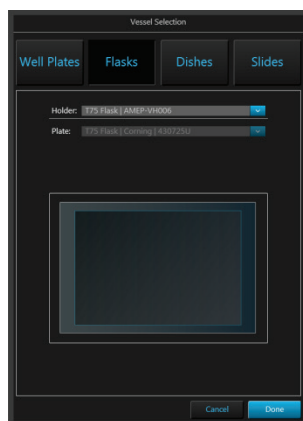

Flasks

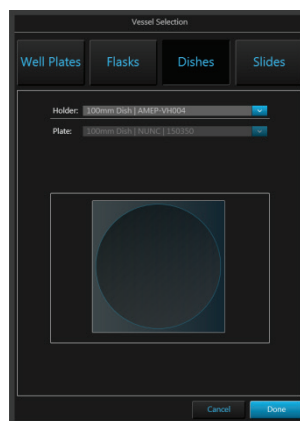

Dishes

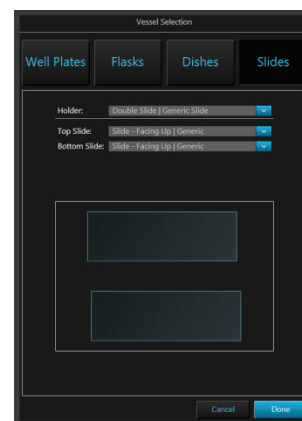

Slides

**Note:** The controls available in the Vessel Selection dialog are contextual; the dropdown menus display only the options available for the selected vessel category.

- Select the appropriate **Holder** and **Vessel type** from the dropdown menus available for your vessel category.

The following images are example screens from the Vessel Selection dialog for vessel holder and vessel type selection for each of the vessel categories.

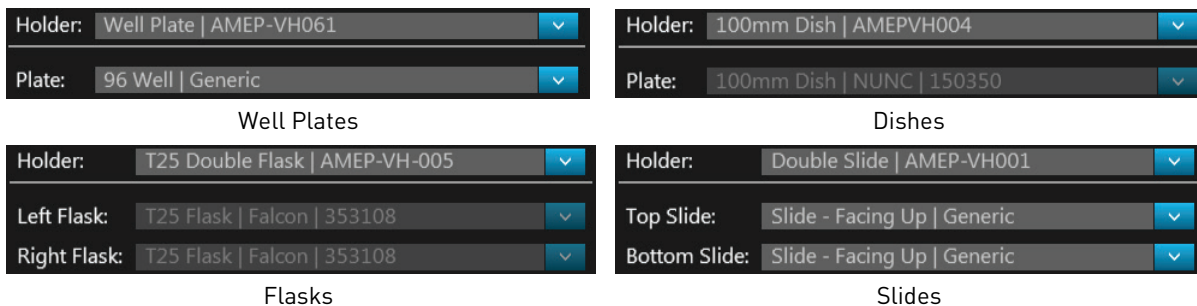

- ② **Vessel map:** Represents the vessel container (vessel + vessel holder) in use, as determined by the selection made in the Vessel selection dropdown. The well selected for imaging is indicated in blue on the Vessel map.

- To select a well to display in the Viewing area, click on the desired well, flask, dish, or slide.

In the following examples, the first well of a 96-well plate and the first dish on a 35-mm quad dish holder have been selected.

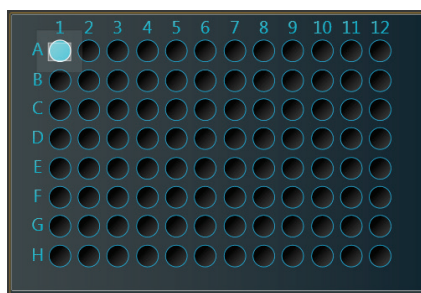

96-well plate

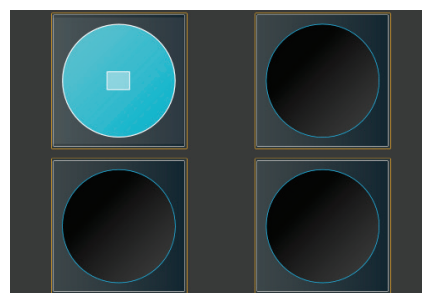

35-mm dishes on a quad dish holder

- When in the **Live mode** (page 143), the Vessel map displays crosshair that aid in navigation around the vessel or well, as shown below.

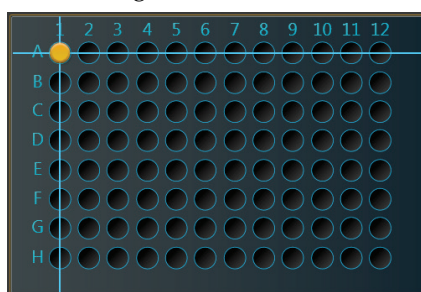

96-well plate

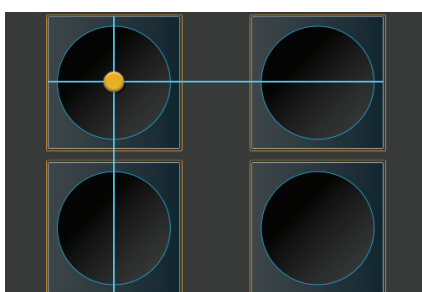

35-mm dishes on a quad dish holder

- To move the stage to another location on the sample vessel to display a different field, click and drag the **crosshair** to the corresponding location on the virtual vessel.
- When the Light is off (i.e, not in the Live mode), click on a different well on the Vessel map to move the **crosshair** to the same relative position as the previous well.

③ **Zoom:** Opens a larger view of the Vessel map.



- This view shows the same content as the smaller Vessel map and behaves the same way.
- Clicking the button again closes the zoom window.

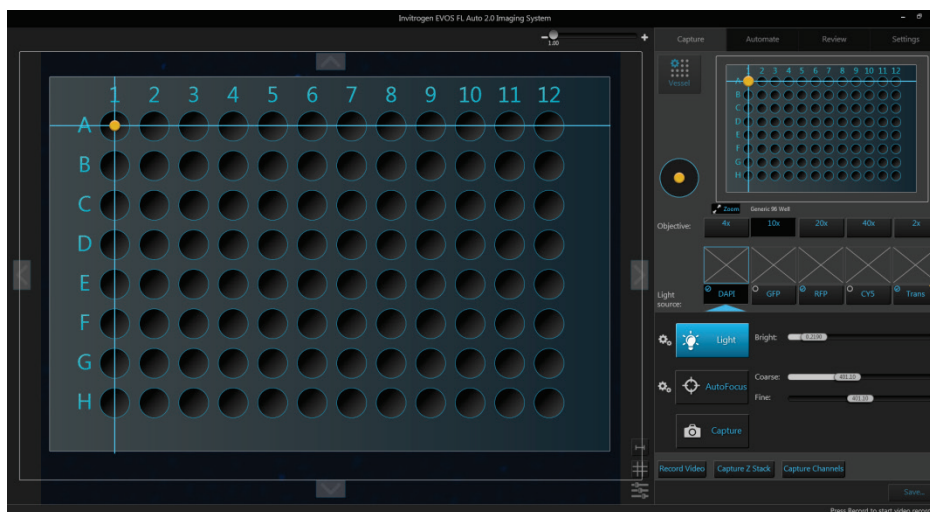

④ **Objective:** Used to select from the currently installed objectives.

- The magnification displayed on the objective button reflects the profile specified in Objective setup on the Settings tab.
- You can select only one objective at a time. In the example below, the 10X objective is selected.



⑤ **Thumbnail images:** Display the most recently captured image stored in the memory buffer for the specific channel.

- If unsaved, newly captured images will overwrite the previously captured image in the channel.
- If no image has been captured for the channel, the corresponding thumbnail will be blank.
- If z-stack was captured in the channel, the **z-stack** icon on the top left corner of the thumbnail image for that channel identifies the image as a z-stack projection.
- You can delete an image captured in a channel by clicking the **Delete channel image** icon on the top right corner of the thumbnail image for that channel.



In the example below, GFP channel displays the thumbnail for a z-stack projection while the RFP channel displays the thumbnail for a field captured at single focal plane. The rest of the channels do not have any images captured.

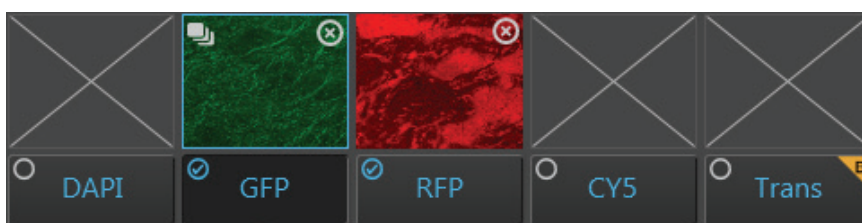



⑥ **Light source:** Selects the desired light source from the installed LED light cubes (fluorescent channels) or transmitted light from the condenser (brightfield).

- Click a **Light source** button to select the corresponding channel for capture. The selected channel is indicated by the blue arrow underneath the corresponding light source button. You can select only one light source at a time for capture.
- Check the **Toggle channel display** option located on the top left corner of the Light source button to select the corresponding channel for display in the Viewing area. You can select multiple channels for display.

In the example below, the GFP channel is selected for capture and both GFP and RFP channels are selected for display.



⑦ **Light (Live mode):** Turns on the excitation light for the currently selected light cube and enters the instrument in the **Live mode**. The Live mode allows rapid visualization of a large sample area illuminated with the selected light source before image capture.

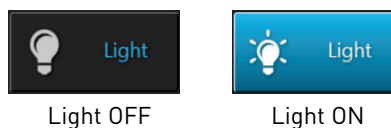

- Clicking the **Light button** a second time or capturing an image turns the light off and exits the instrument from the Live mode.
- In the Live mode, the Viewing area shows the sample illuminated under the selected light source in pseudo-color with the default emission color.

In the example below, the sample is illuminated in the GFP channel.

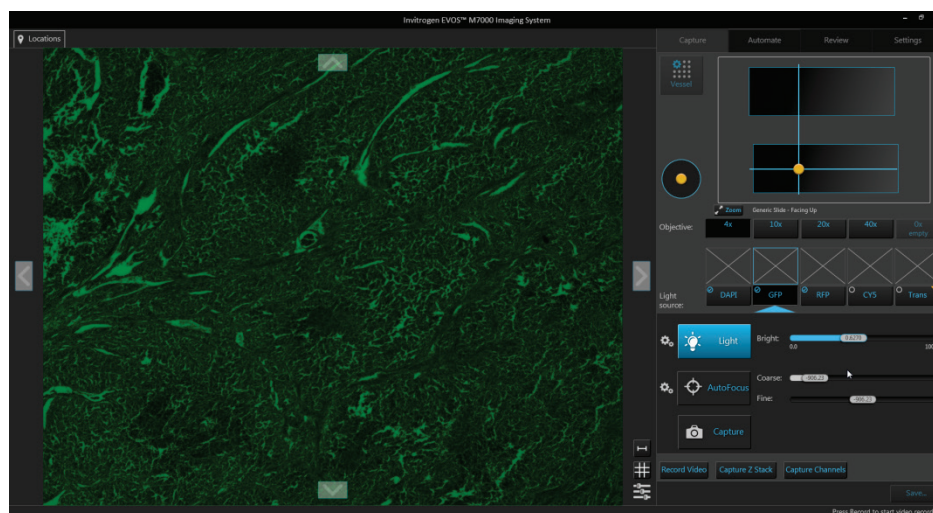

- The Vessel map displays the navigation crosshair, and the **Jog Control** button appears next to the Vessel map.
- **Jog Control** moves the stage at an intermediate pace, allowing the quick scanning of the sample in different parts of the sample vessel.





- ⑧ **Brightness and camera settings:** Opens the Brightness and camera settings window, which allows you to set Mode, Camera, and Phase options for the selected light source. Clicking the button again closes the window.

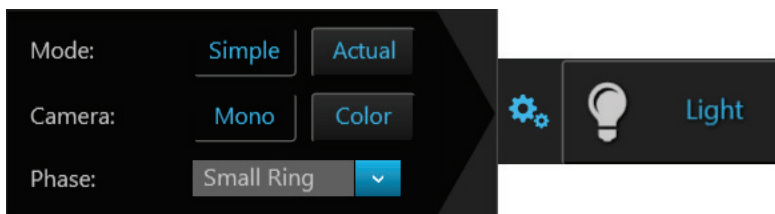

- **Mode:** Toggles between **Simple** and **Actual** modes for brightness controls.
  - **Simple mode** allows you to control light intensity as a single **Brightness** parameter (page 149).
  - **Actual mode** allows you to adjust **Light** (i.e., LED intensity), **Exposure**, and **Gain** parameters individually.
- **Camera:** Toggles between the **Mono** (monochrome) and **Color** cameras.
  - **Mono** is used for image capture in fluorescence and transmitted light (brightfield) channels. It uses a high-sensitivity 3.2 MP CMOS monochrome camera with 2048 × 1536 pixel resolution.
  - **Color** is used for image capture in the brightfield channel only. It uses a high-sensitivity 3.2 MP CMOS color camera with 2048 × 1536 pixel resolution.
- **Phase:** Selects between **Phase** options and **Brightfield** in the transmitted light channel only. Phase contrast options change the phase annuli being used to match the objective with a specific magnification. Available options are:
  - **Small Ring:** Used for objectives with low magnification (i.e., Olympus™ 4× PH)
  - **Medium Ring:** Used for objectives with medium magnification (i.e., EVOS™ 4×/10× PH)
  - **Large Ring:** Used for objectives with high magnification (i.e., EVOS™ 20×/40× PH)
  - **Brightfield** (phase contrast off)

---

**Note:** Phase options are available only for the transmitted light (brightfield) channel; they are not available for fluorescence channels. The phase contrast option does not require phase contrast objectives. However, to obtain a phase image, you must first install a phase contrast objective.

---

- ⑨ **Autofocus:** Runs the autofocus algorithm in the currently selected channel to find the best focus position for the sample. This button is available on both Capture and Automate tabs.

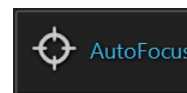

- The Autofocus window displays the image from the selected channel in real time as the instrument searches for the optimal focus.

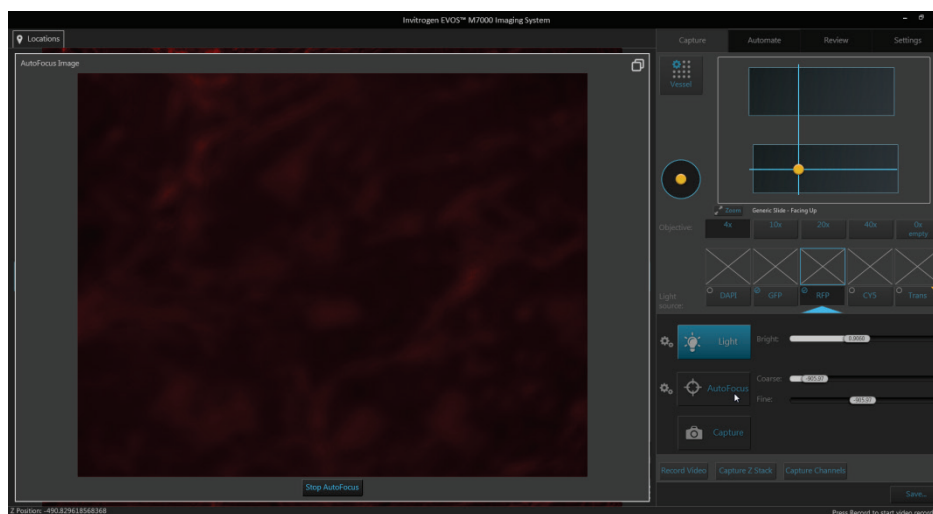

- To minimize the Autofocus window, click the **minimize** button.

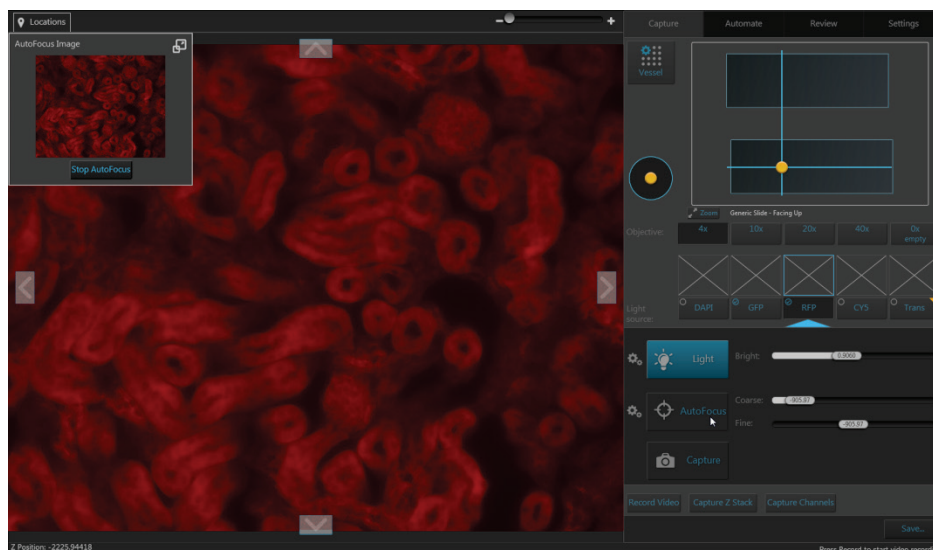

Once minimized, the Autofocus window can be moved around the Viewing area.

To expand the Autofocus window, click the **expand** button.



- Click **Stop AutoFocus** in the Autofocus window to abort the autofocus procedure.

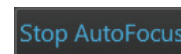

- ⑩ **Advanced focus settings:** Opens the Advanced focus settings window, which contains the controls listed below. Clicking the button again closes the window.

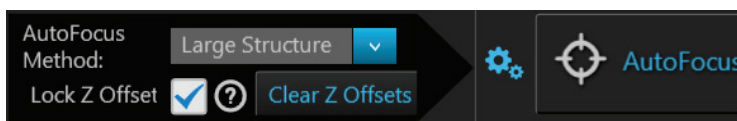

- **Autofocus method:** Allows you to select the autofocus method best suited for your experimental needs. Available options are:
  - **Fluorescence Optimized:** The focal plane is derived from the highest ratio between detailed, high-contrast objects against the background. This option is recommended for fluorescence imaging.
  - **Transmitted Optimized:** The optimal focal plane is derived through statistics-based edge detection over 9 different regions to determine the highest ratio of edge-to-background. This option is recommended for transmitted-light imaging.
  - **Small Structure:** This method computes the energy according to the size of image features and can measure the presence or absence of small image features.  
Choose this method when capturing images of samples that have many fine, hair-like structures (e.g., filaments or structural stains).
  - **Large Structure:** This method is statistics-based and looks for large changes in image content as parts of the image go in and out of focus. Choose this method when your sample contains large structures (e.g., whole cell stains).
  - **Small Bright Objects:** This method looks for changes in brightness at the center of the cell and optimizes focus on cells that have a bright center with a dark surround area.  
Choose this method when capturing samples with localized staining (e.g., nuclei).

---

**Note:** The effectiveness of the autofocus method depends on the plate type, sample type, biomarker intensity, magnification, and channel. It may be necessary to use different algorithms for different channels. This ensures the best autofocus is used for your sample.

---

- **Lock Z-Offsets:** Allows you to lock the Z-Offsets, which specify the optimal focus position in each channel relative to the focus position in other channels.
  - When locked, adjusting the Z-position in one channel changes the Z-position in all channels, preserving the relative Z-positions of the channels.
  - When unlocked, adjusting the Z-position in one channel does not affect the Z-position set for the other channels.

For an example, see “Note” on page 147.

For more information on configuring the autofocus settings for an automated scan protocol, see page 176.

---

**Note:** Consider a scenario where the initial Z-positions of the DAPI and RFP channels are 50  $\mu\text{m}$  and 80  $\mu\text{m}$ , respectively. The autofocus is run from the DAPI channel and finds the best focal plane at a Z-position of 60  $\mu\text{m}$ .

If the autofocus is selected to run from a single channel, then the Z-Offsets will be locked, and the RFP channel will be focused to a Z-position of 90  $\mu\text{m}$ .

If the autofocus is run from all channels, then the Z-Offsets will not be locked, and the autofocus algorithm will find the best focal plane for the RFP channel independently of the DAPI channel.

---

- **Clear Z-Offsets:** Clears the Z-Offsets.

- ⑪ **Capture:** Captures an image of the selected field using the current capture settings and stores it in the image cache of the channel in which it was captured.
- Field View displays the captured image. If multiple images are captured in the same field of view using different channels, the captured images are displayed as an overlay.
  - The captured image is also be displayed above the Light source button for the specific channel in which the image is captured.
  - A thumbnail of the captured image is displayed in Area View at the location of its capture when the zoom level is greater than one field of view.

The examples below show the Field View (top) and the Area View (bottom) after the same field has been captured in DAPI and GFP channels.

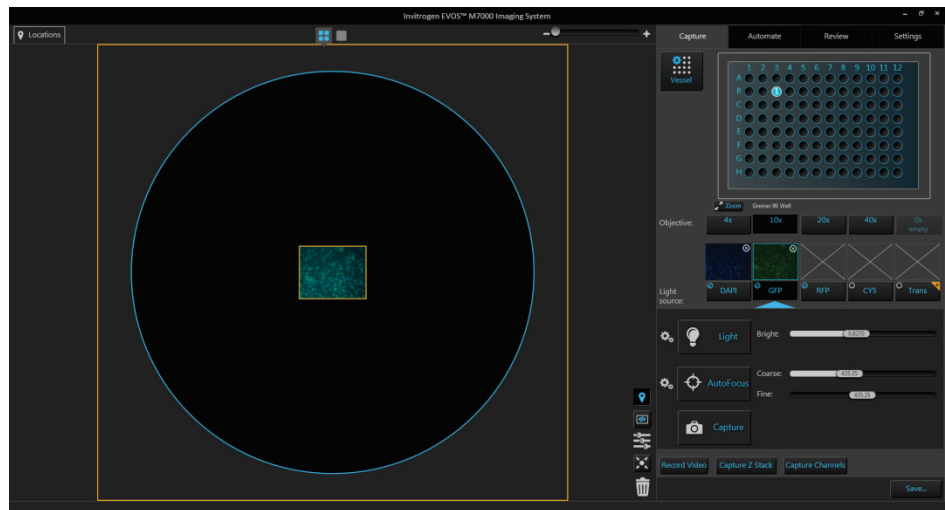
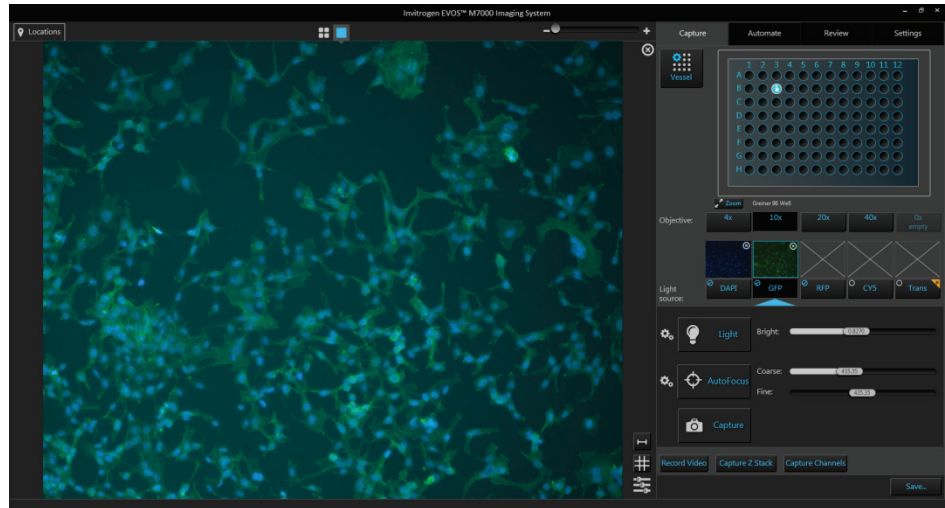

**Note:** Captured images are stored in the image cache for the selected channel. If unsaved, newly captured images of the same field will overwrite the previously captured image in that channel.

- ⑫ **Brightness controls:** Control the brightness settings for the selected channel. You can adjust the brightness settings for each channel independently without affecting the settings for other channels.

To adjust the settings for a given parameter, move the corresponding slider in the desired direction or enter the desired value in the **text box**.

- In the **Simple mode**, light intensity is controlled as a single **Brightness** parameter and expressed as a percentage between 0% and 100%.



Brightness slider (Simple mode)

- In the **Actual mode**, brightness is controlled as individual **Light** (LED intensity), **Exposure**, and **Gain** parameters.



Light Exposure, and Gain sliders (Actual mode)

Brightness parameters in the Actual mode have the following ranges:

**Light:** 0–100%

**Exposure:** 0–4 seconds

**Gain:** 1–8

---

**Note:** For best results, optimize the brightness parameters as follows:

- **When searching for sample:** Increase **Gain** for a brighter signal and decrease **Exposure** for faster frame rate during navigation around the vessel.
- **When capturing image:** Decrease **Gain** to reduce background noise and increase **Exposure** to regain signal intensity, as needed.
- **For brighter signal:** Increase **Light** intensity for brighter illumination. If needed, follow by increasing **Gain**.
- **For time lapse imaging:** Increase **Gain** and **Exposure**, and decrease **Light** intensity to reduce photobleaching and phototoxicity.

For example, for overnight time lapse experiments, capture one image every 30 minutes or less, limit the use of autofocus, and use a channel other than DAPI for autofocus.

---

- ⑬ **Focus sliders:** Used for the manual adjustment of focus for the current channel. The focus position is expressed in  $\mu\text{m}$  along the z-axis.

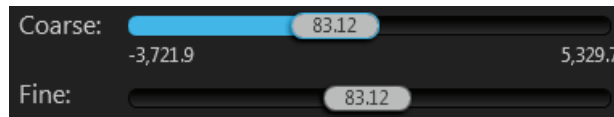

- The coarse focus slider bar represents the full focal range of the instrument while the fine focus slider bar represents only a small fraction of the full focal range.
- **Coarse focus slider handle** can be placed at any point within the focal range of the instrument.
- **Fine focus slider handle** can be dragged as far as either end of the slider bar, but it will snap back to the center position upon release.
- You can adjust the focus by moving the **focus sliders** in the desired direction.

Alternatively, you can double-click on the handle of the focus slider to activate the text box and enter the desired value for the focus position.

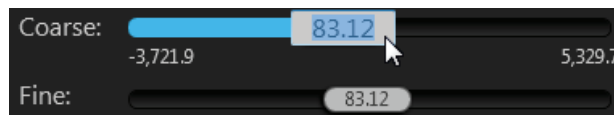

- If the instrument is in the **Live mode**, the live image changes in effective real-time to reflect the changes made to the focus.

- ⑭ **Record Video:** Opens the Record Video controls, which allow you to record capture a series of live images and compile them into a video.

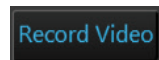





- Record Video controls are available only in the **Live mode**.

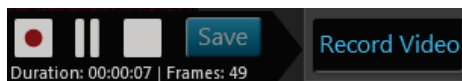

- Click **Record**  to start recording live images.

Duration and frames recorded are displayed under the Record Video controls.



- Click **Pause**  to pause recording live images.
- Click **Stop**  to finish recording.
- Click **Save**  to open the Save Video window.

The Save Video window follows the standard Windows™ file navigation system and allows you to save the captured video in the desired location.

You can choose to record your video in **AVI** or **WMV** formats.



- ⑮ **Incubator:** Opens Incubator tab, which allows you to control the EVOS™ Onstage Incubator and monitor its status during your experiments.

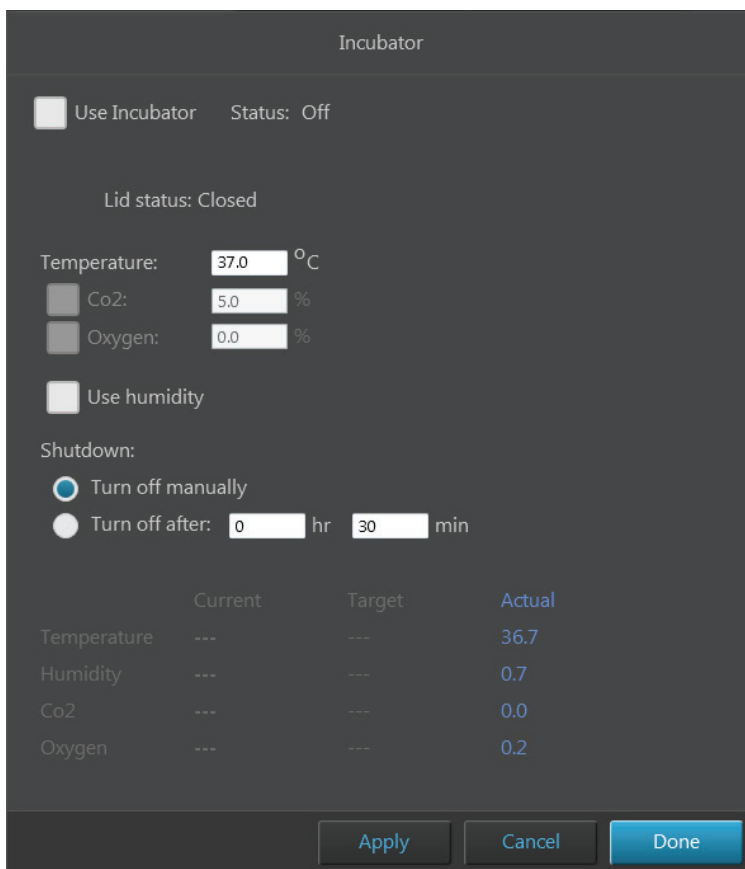

- **Use Incubator:** Enables the use of the EVOS™ Onstage Incubator.
- **Temperature:** Sets the incubator temperature (ambient to 40°C).
- **CO<sub>2</sub>:** Sets the CO<sub>2</sub> level (0% to 20%).
- **Oxygen:** Sets the oxygen level (0% to 20%).
- **Use humidity:** Enables the use of humidified atmosphere in the incubation chamber.
- **Shutdown:** Allows you select between manual shutdown or automatic shutdown after a specified time period.
- **Incubator status:** Displays the current temperature, humidity, CO<sub>2</sub>, and oxygen values against the target values.

	Current	Target	Actual
Temperature	OK	37.0	37.4
Humidity	OK	Off	0.7
Co2	---	---	0.0
Oxygen	---	---	0.2

**Note:** The EVOS™ Onstage Incubator (Cat. No. AMC1000) is an optional accessory that enables the incubation of cells directly on the automatic X-Y stage, allowing the capture of images from the same sample over long periods of time and recording of time lapse movies.

- ⑩ **Capture Z Stack:** Opens Z-Stack Settings window, which allows you to capture multiple images along the z-axis based on your specifications.

Capture Z Stack

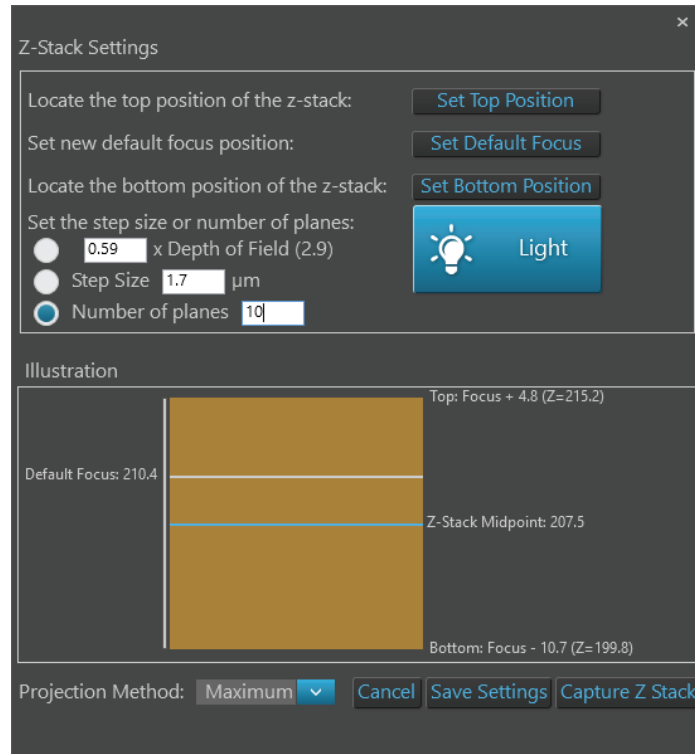

- **Light:** Turns on the light source in the selected channel to illuminate the sample as you locate the top and bottom boundaries of the z-stack using the focus sliders. Click the button again turns off the light.
- **Set Top Position:** Sets the current focal plane reached using the focus sliders as the top position of the z-stack.
- **Set Default Focus:** Specifies the new default focus position for the z-stack.
- **Set Bottom Position:** Sets the current focal plane reached using the focus sliders as the bottom position of the z-stack.
- **Step Size:** Describes the z-distance in  $\mu\text{m}$  between the successive focal planes that are captured for the z-stack. Available methods to specify the step size are:
  - **Multiple of Depth of Field:** Enter the step size as multiple of depth of field.
  - **Step Size:** Enter the step size in  $\mu\text{m}$  in the corresponding text box.
- **Number of planes:** Specifies the number of focal planes that are captured to generate the z-stack. Each captured image along z-axis represents a single “optical section” of the sample.

- **Illustration:** Graphically demonstrates the z-stack parameters. As you enter the z-stack parameters, **Illustration** is automatically updated to reflect the new settings.

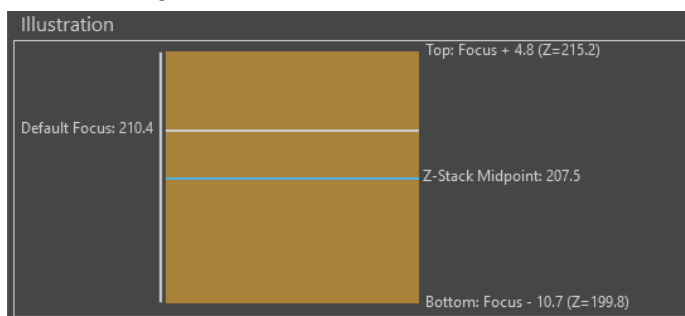

- The Z-Stack Midpoint is represented by a blue line. Half of the images captured for the z-stack are above this position and half are below it.
- The default focus position is represented by a white line.
- The orange rectangle represents the z-stack depth. It is the product of step size and number of planes.
- The positions of the bottom and the top focus positions and the position of the Z-Stack Focus are indicated in  $\mu\text{m}$  next to the orange rectangle representing the z-stack depth.
- **Projection Method:** Determines the mathematical algorithm that will be used to extract the most in-focus pixels from the images captured at different focal planes to generate the z-stack projection.
  - **Maximum:** For fluorescent images that are bright on dark background.
  - **Standard deviation (StDev):** For unstained transmitted images where the objects are identified by the contrast instead of the intensity.
  - **Average:** For fluorescent or histochemically-stained transmitted images when assessing concentration of the stain/marker.
- **Capture Z Stack:** Captures the z-stack images based on your specifications.
- **Save:** Saves the z-stack settings for future use in the current or another selected channel.
 

Clicking **Save** closes the Z-Stack Settings window. To capture z-stack images, click **Capture Z-Stack** to re-open the Z-Stack Settings window.
- **Cancel:** Closes the Z-Stack Settings window without capturing z-stack images or saving z-stack settings.

---

**Note:** You can capture z-stack images in only one channel at a time; however, you can save z-stack images of a field captured in different channels as a single merged video.

---

- ⑰ **Capture Channels:** Captures a selected field in multiple channels simultaneously.

Capture Channels

Before capture, each channel to be acquired must be selected by clicking on the small circular checkbox located on the upper left corner of the corresponding light source button.

In the example below, DAPI, RFP, and transmitted light (brightfield) channels have been selected for simultaneous capture.

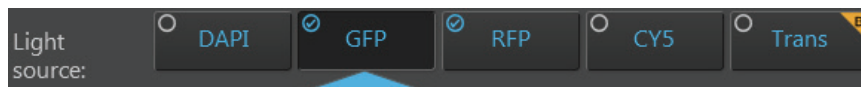

- ⑱ **Save:** Opens the Save options window, which allows you to select a save location and to set save options.

Save...

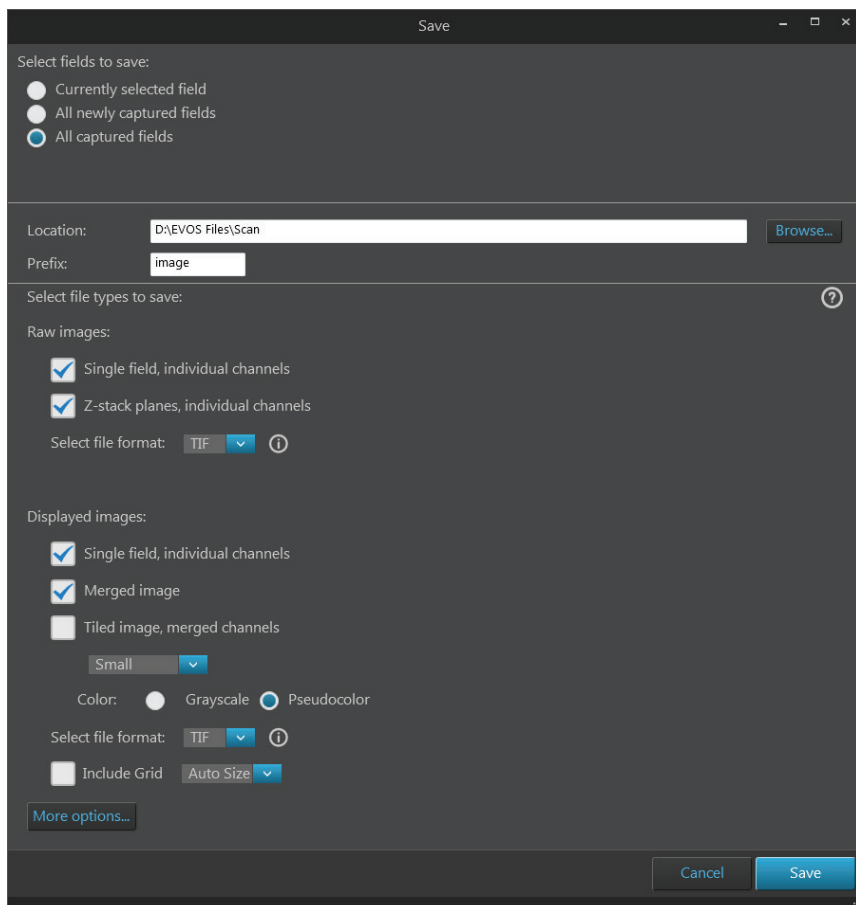

- **Select fields to save:** Allows you to select the captured fields you want to save. You can choose from the following options:
  - **Currently selected field:** Saves images only from the current field.
  - **All newly captured fields:** Saves images that have been captured and stored in the image cache, but not yet saved. This option is available only if you have previously saved images from the same session.
  - **All captured fields:** Saves images from all captured fields that are held in the image cache. This is typically all of the images that you have captured during an imaging session.
- **Location:** Describes the location of the current folder or file.

Location: C:\Users\ali.ozgenc\Documents\EVOS\_Files

- **File name prefix:** Allows you assign a prefix to your saved images.

File name prefix:

The default prefix for images captured in the Capture tab is “image”.

- **Browse:** Opens the Select Folder window, which allows you to assign a destination folder for your saved images.

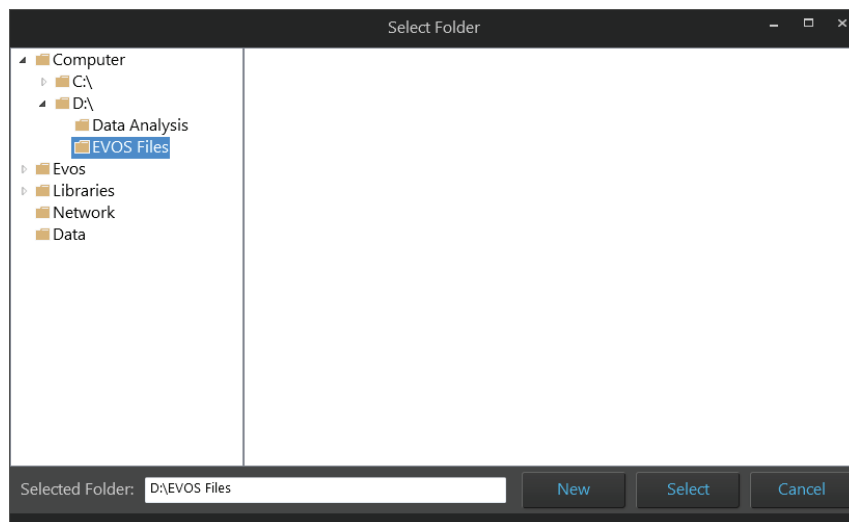

- **Select file types to save:** Allows you to set image save options. You can select one or more of the following options:

- **Raw images:** Saves images from individual channels as 16-bit raw images. This is the recommended format for image analysis and quantitation (see “Raw vs. Displayed images”, page 125).

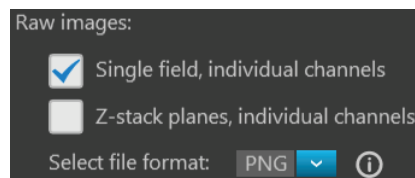

Available save options for raw images are:

- **Single field, individual channels:** Saves images captured in each field and each channel individually.
- **Z-stack planes, individual channels:** Saves individual z-stack images as well as the z-stack projection for each field and channel.

Available file formats for Raw images are:

- **TIFF:** No or low image compression with no loss in image quality.
- **PNG:** High image compression with no loss in image quality.
- **C01:** Thermo Fisher™ proprietary format. Only images captured by monochrome cameras may be saved in this format.
- **DIB:** Color corrects across devices for true viewing. Only images captured by monochrome cameras may be saved in this format.

---

**Note:** When viewing 16-bit images on most standard image viewers, they will appear very dark or almost totally black, especially if a low exposure setting was used. These images either need to be converted for display or opened in a software application that allows viewing of 16-bit images such as the Thermo Scientific™ Celleste™ Image Analysis Software (Cat. No. AMEP4816).

---

- **Displayed images:** Allows you to save images in a format that can be viewed in most image display applications. This is the recommended format for “prettiest” images (see “Raw vs. Displayed images”, page 125).

Displayed images from individual channels can be saved separately or as a merged or tiled image, using either 24-bit pseudocolor (8-bit per RGB channel) or grayscale (16-bit).

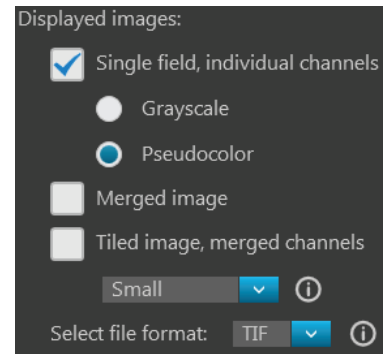

---

**Note:** While pseudocolors help differentiate the channels used in multi-channel overlays, grayscale images usually show more detail.

---

**Note:** 24-bit images (8-bit per RGB channel) are NOT recommended for image analysis as not all channels will display in many image analysis applications.

---

Available save options for raw images are:

- **Single field, individual channels:** Saves images captured in each field and each channel individually. You can select **Grayscale** (16-bit) or **Pseudocolor** (24-bit RGB; 8-bit per RGB channel).
- **Merged image:** Combines the images captured in different channels into a multicolor overlay and saves the merged image in 24-bit Pseudocolor (8-bit per RGB channel). It is also referred to as a composite image.
- **Tiled image:** Merges the images captured in each channel and places them very close together into a tiled format without applying an algorithm. The resulting image is not seamless, but the process is quicker than stitching and is often sufficient for most applications.

You can create tiled images with the following dimensions:

- **Small** (2000 × 2000 pixels)
- **Medium** (4000 × 4000 pixels)
- **Large** (10,000 × 10,000 pixels)
- **Maximum** (26,000 × 26,000 pixels)

---

**Note:** For more information about when to use tiled or stitched images, see “Tiled, Stitched, and Merged images”, page 125.

---

Available file formats for raw images are:

- **TIFF:** No image compression with either no loss in image quality (16-bit Raw) or reduced (8-bit) dynamic range (Microsoft-compatible TIFF).
- **PNG:** Medium image compression with no loss in image quality.
- **JPEG:** High image compression with little loss in image quality; good for sharing.
- **BMP:** No image compression with no loss in image quality.

---

**Note:** If you plan to analyze your images, save them in 16-bit TIFF Raw format. The 16-bit dynamic range is required for analysis and there is additional information in the file headers, including OME data, that can be useful.

---

# Automate tab

## Automate tab overview

Automate tab consists of a series of panels, which are organized by functionality and contain the controls necessary to create and recall automated scan protocols.

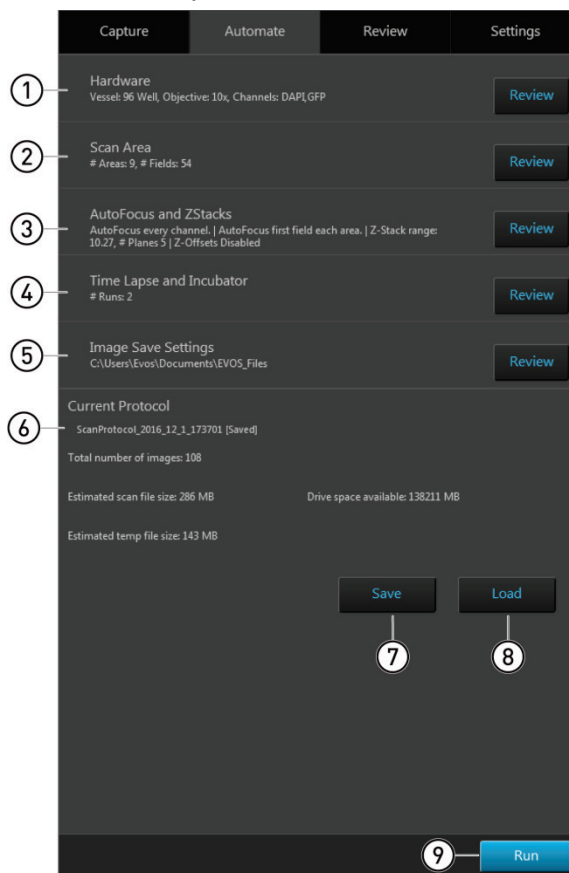

- ① **Hardware:** Allows you to configure hardware options (such as sample vessel, objective, light source etc.) for the scan protocol (page 158).
- ② **Scan Area:** Allows you to specify the scan areas and fields to capture for the scan protocol (page 159).
- ③ **AutoFocus and Z Stacks:** Allows you to configure AutoFocus options and Z-Stack settings for the scan protocol (page 172).
- ④ **Time Lapse and Incubator:** Allows you to specify time lapse options (duration, capture frequency etc.) and incubator settings (temperature, oxygen etc.) for the scan protocol (page 180).
- ⑤ **Image Save Settings:** Allows you to select a save location for captured images and to set image save options (page 186).
- ⑥ **Current Protocol:** Displays the name of the currently selected scan protocol and provides additional information (total number of images, estimated scan file size, estimated temporary file size, and drive space available).
- ⑦ **Save:** Saves the automated scan protocol for future experiments.
- ⑧ **Load:** Opens the Load dialog, which allows you to recall a previously saved scan protocol to run with new samples.
- ⑨ **Run:** Runs the automated scan protocol (newly created or recalled).



## Hardware

Hardware panel allows you to select and edit hardware options (such as sample vessel, objective, light source etc.) and adjust settings for the current scan protocol.

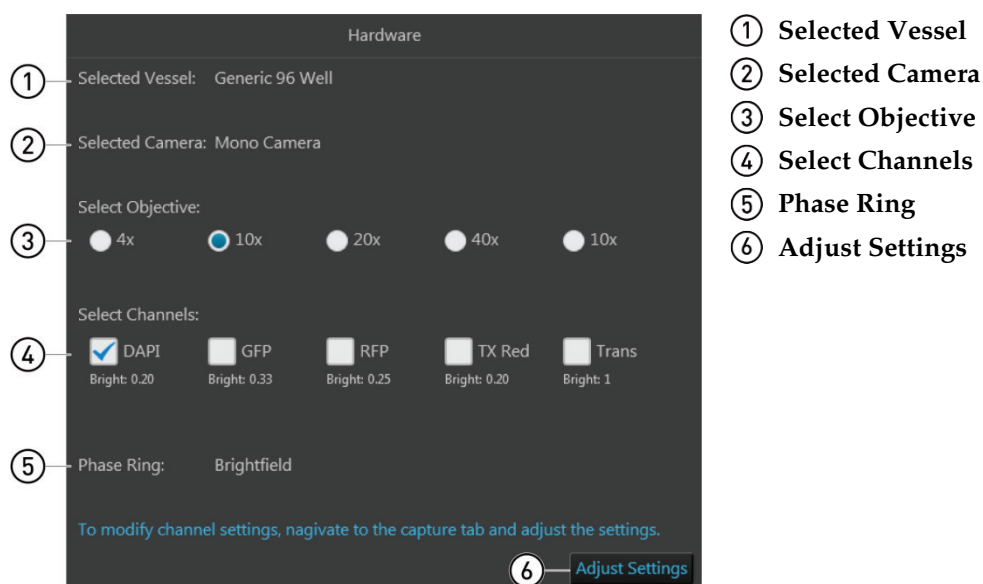

## Hardware controls

- ① **Selected Vessel:** Displays the selected vessel type. For more information, see “Vessel” in “Capture tab controls”, page 140.
- ② **Selected Camera:** Displays the selected camera. For more information, see “Brightness and camera settings” in “Capture tab controls”, page 144.
- ③ **Select Objective:** Allows you select the objective for the scan protocol from the currently installed objectives.  
You can select only one objective at a time. In the example below, the 10X objective is selected.

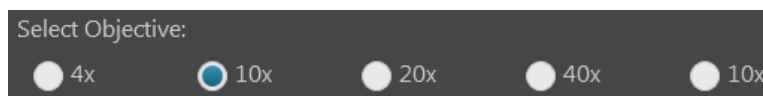

- ④ **Select Channels:** Allows you to select the channels you want to capture in the scan protocol. The brightness value set in the Capture tab for each channel is displayed below the corresponding checkbox.  
You can select multiple channels by checking the corresponding channel boxes. In the example below, the DAPI and GFP channels have been selected.

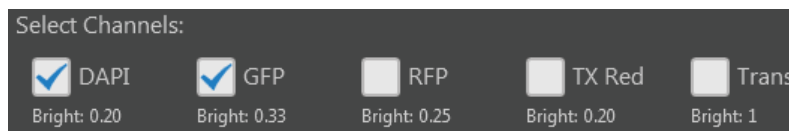

- ⑤ **Phase Ring:** Displays the phase option selected for the transmitted light (brightfield) channel. For more information, see “Phase” in “Capture tab controls”, page 144.
- ⑥ **Adjust settings:** Allows you to modify channel settings for the scan protocol in the Capture tab (page 134).

[Adjust Settings](#)

In the capture tab, you can change **Brightness and camera settings** (page 144), adjust **Brightness** parameters (page 149), and select a different **Vessel** (page 140) and **Objective** (page 142).

## Scan Area

Scan Area panel allows you to define the areas and fields you want to scan in the automated scan protocol and specify the order in which they are captured.

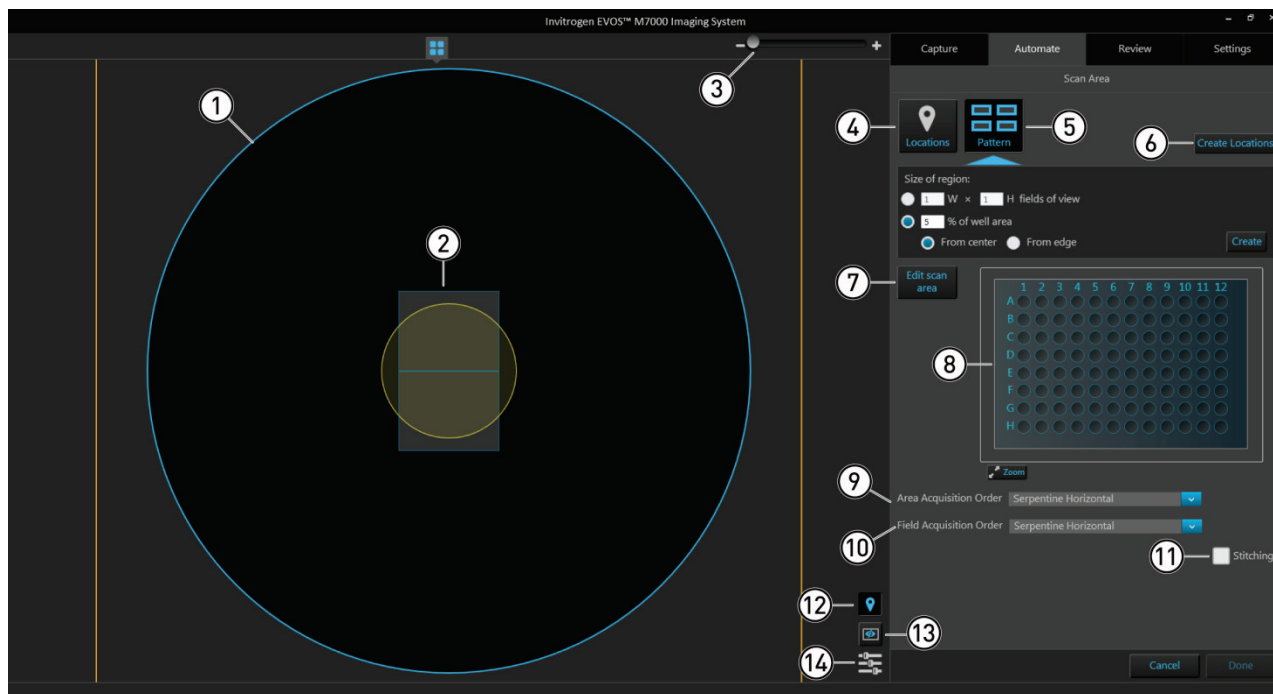

- |                               |                                       |
|-------------------------------|---------------------------------------|
| ① Area View (page 160)        | ⑧ Vessel map (page 169)               |
| ② Capture region (page 161)   | ⑨ Area acquisition order (page 169)   |
| ③ Zoom slider (page 161)      | ⑩ Field acquisition order (page 169)  |
| ④ Scan Locations (page 161)   | ⑪ Stitching (page 170)                |
| ⑤ Scan Pattern (page 166)     | ⑫ Toggle locations display (page 170) |
| ⑥ Create Locations (page 167) | ⑬ Toggle field borders (page 170)     |
| ⑦ Edit scan area (page 168)   | ⑭ Image display settings (page 171)   |

**Note:** If using a single culture dish, flask, or slide, the scan area corresponds to the entire dish, flask, or slide. As such, the scan area displayed in Area View represents the entire dish or flask selected.

In a multi-well plate, multi-chamber slide, or multiple dishes on multi-dish holders, each scan area corresponds to a single well, chamber, or dish.

You can specify multiple areas to scan, but the Area View displays only the current (i.e., active) scan area.

## Scan Area controls

① **Area View:** Represents the target scan area from which specific fields are selected for the scan protocol.

- In a single culture dish or flask, the scan area corresponds to the entire dish or flask. As such, the scan area displayed in Area View represents the entire dish or flask selected.

In the example below, the sample vessel is a single 60-mm culture plate, and the Area View corresponds to the entire plate.

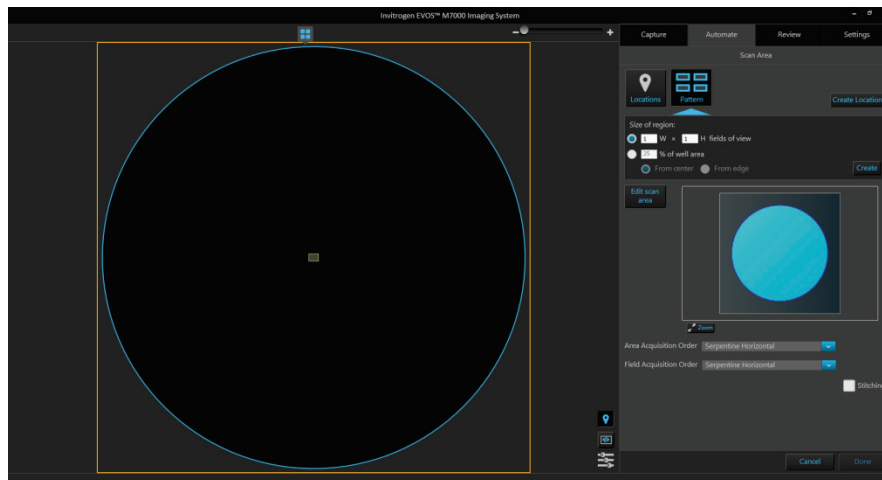

- In a multi-well plate or a multi-chamber slide, each scan area corresponds to a single well or chamber. You can specify multiple areas to scan, but the Area View displays only the current (i.e., active) scan area.

In the example below, the sample vessel is a 6-well plate. Although the first three wells have been selected for capture, the Area View displays only the active first well.

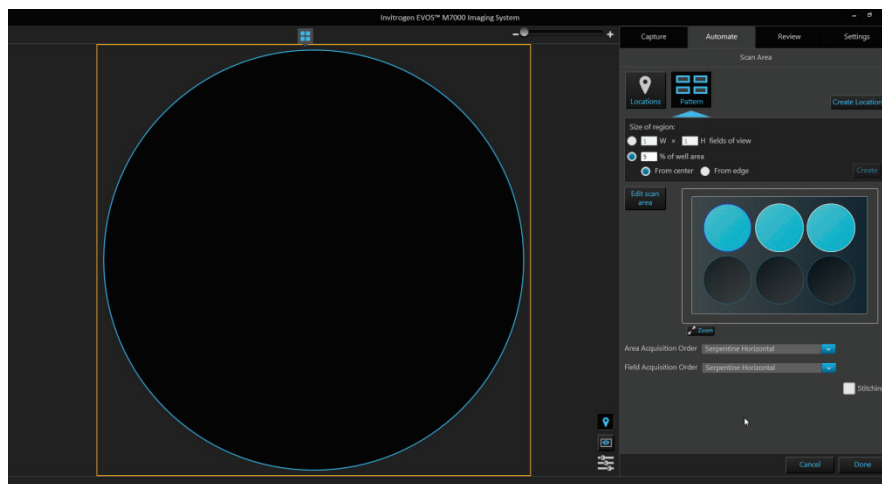

- When using the **Scan Locations** tool (page 161), the scan areas are selected using the **Assign scan area** button (page 164).

When using the **Scan Pattern** tool (page 166), the scan areas are selected from the **Vessel map** using the **Edit scan area** button (page 168).

- When multiple scan areas have been defined, you can specify the order in which they are captured using the **Area Acquisition Order** (page 169).
- You can specify the order in which the selected fields are captured using the **Field Acquisition Order** (page 169).

② **Capture region:** Represent the regions to be captured in a scan protocol.

The regions to be captured consist of fields of view that are defined using the **Scan Locations** or **Scan Pattern** tools. You can select multiple regions for automated capture.

In the following example, the capture region was defined as 15 fields of view (5 W × 3 H) using the Scan Pattern tool.

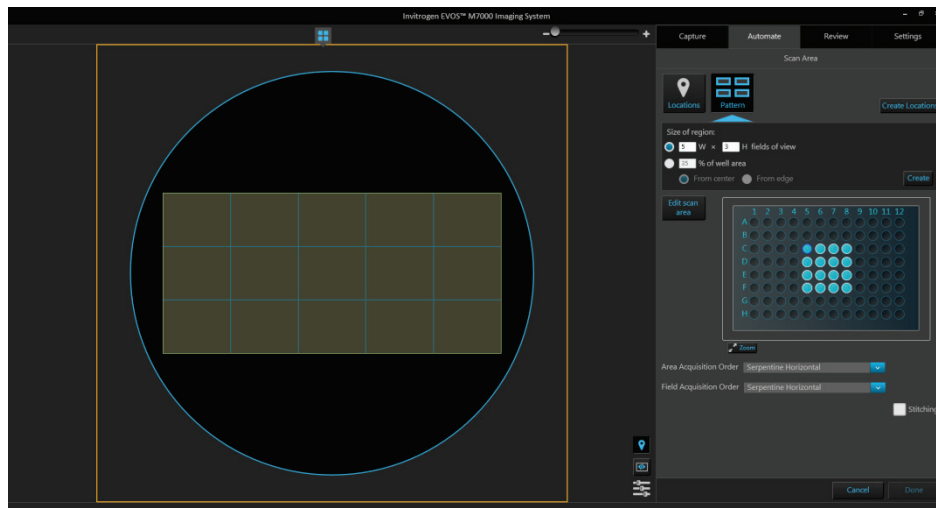

③ **Zoom slider:** Zooms in and out of the Viewing area.



④ **Scan Locations:** Opens the **Locations** tool, which allows you to define the capture regions and assign scan areas for the scan protocol.

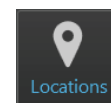

- Locations are defined using the **Locations** tool (page 134).
- Locations that have already been defined with the Locations tool are listed in the **Available Locations** table.

The Available Locations table also provides information about the name and shape of each location, and the number of fields it contains.

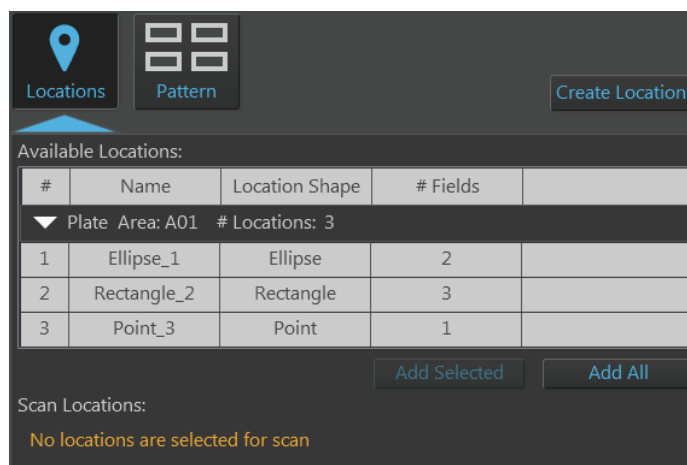

- If there are no previously defined locations, the **Available Locations** table displays the message “No locations are available for selection”.

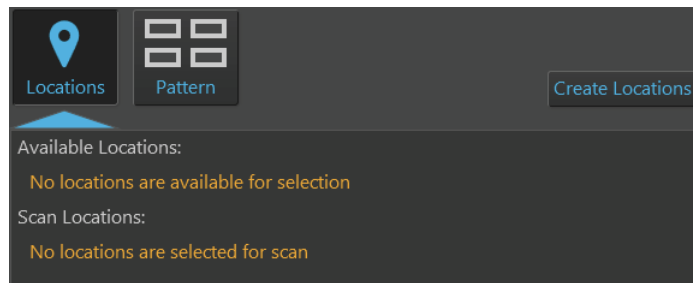

- To create new locations for the scan protocol, click **Create Locations** to open the **Locations** tool (page 134).



Using the Locations tool, define the locations as described (page 135), then navigate back to the **Automate** tab ► **Scan Locations**.

Newly created locations will be listed in the Available Locations table.

- To select a location listed in the Available Locations table, click the desired location. The selected location will be highlighted in blue and the Viewing area will display the selected location and shape (if the **Toggle locations display** is on).

Available Locations:

#	Name	Location Shape	# Fields	
▼ Plate Area: A01 # Locations: 4				
1	Ellipse_1	Ellipse	1	
2	Rectangle_2	Rectangle	0	
3	Point_3	Point	1	
4	Freeform_4	Polygon	2	

In the following example, the first location in the list (an ellipse) is selected. The Viewing area displays the selected location and the field group that best fits the shape of the location.

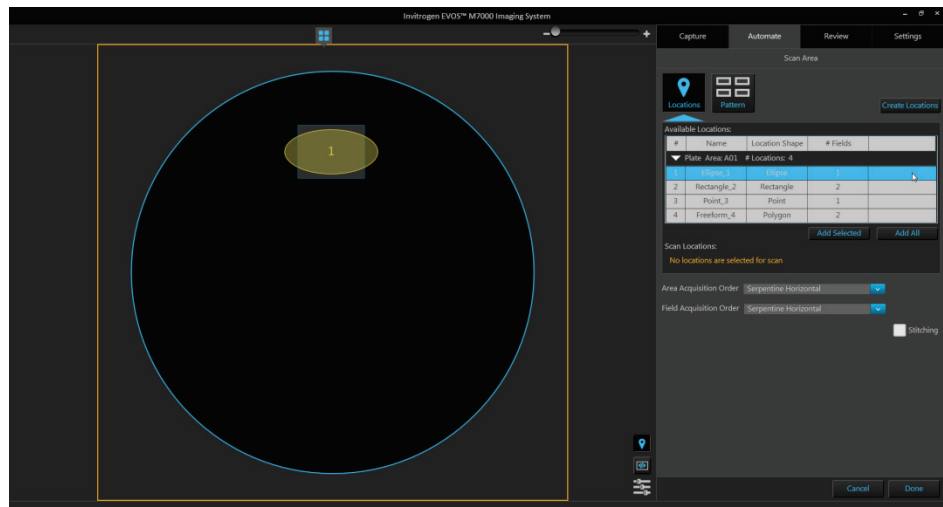

- To add a location to the scan protocol, click the desired location in the Available Locations table to select, then click **Add Selected**.

Available Locations:

#	Name	Location Shape	# Fields	
▼ Plate Area: A01 # Locations: 4				
1	Ellipse_1	Ellipse	1	
2	Rectangle_2	Rectangle	2	
3	Point_3	Point	1	
4	Freeform_4	Polygon	2	

Add Selected    Add All

- To add multiple locations to the scan protocol simultaneously, Shift-click the desired locations in the Available Locations table to select them, then click **Add Selected**.

Available Locations:

#	Name	Location Shape	# Fields	
▼ Plate Area: A01 # Locations: 4				
1	Ellipse_1	Ellipse	1	
2	Rectangle_2	Rectangle	2	
3	Point_3	Point	1	
4	Freeform_4	Polygon	2	

Add Selected    Add All

- To add all of the locations listed in the Available Locations table, click **Add All**.
- The locations added to the scan protocol are displayed in the **Scan Locations** table and removed from the Available Locations table.

The Scan Locations table also provides information about the name and shape of each location, and the number of fields it contains.

In the example below, two locations have been added to the Scan locations list, and one location remains in the Available Locations table.

Available Locations:

#	Name	Location Shape	# Fields	
▼ Plate Area: A01 # Locations: 1				
1	Ellipse_1	Ellipse	2	

Add Selected    Add All

Scan Locations:

#	Name	Location Shape	# Fields	
▼ Plate Area: A01 # Locations: 2				
2	Rectangle_2	Rectangle	3	
3	Point_3	Point	1	

Assign scan area    Remove Selected    Remove All

- To remove a location from the Scan Locations table, click the desired location in the table to select, then click **Remove Selected**.

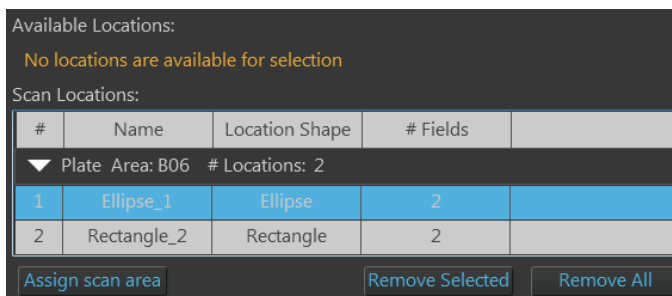

- To remove multiple locations from the Scan Locations table simultaneously, Shift-click the desired locations in the table to select them, then click **Remove Selected**.
- To remove all of the locations listed in the Scan Locations table, click **Remove All**.
- The locations removed from the Scan Locations table appear in the Available Locations table.
- To assign a scan area for the selected scan locations, click **Assign scan area** to open the **Vessel map**, then select the desired areas from the Vessel map to define the scan area (page 165).

Assign scan area

Depending on the vessel in use, scan areas can consist of wells in multi-well plates, chambers in multi-chamber slide, or entire culture flasks or dishes.

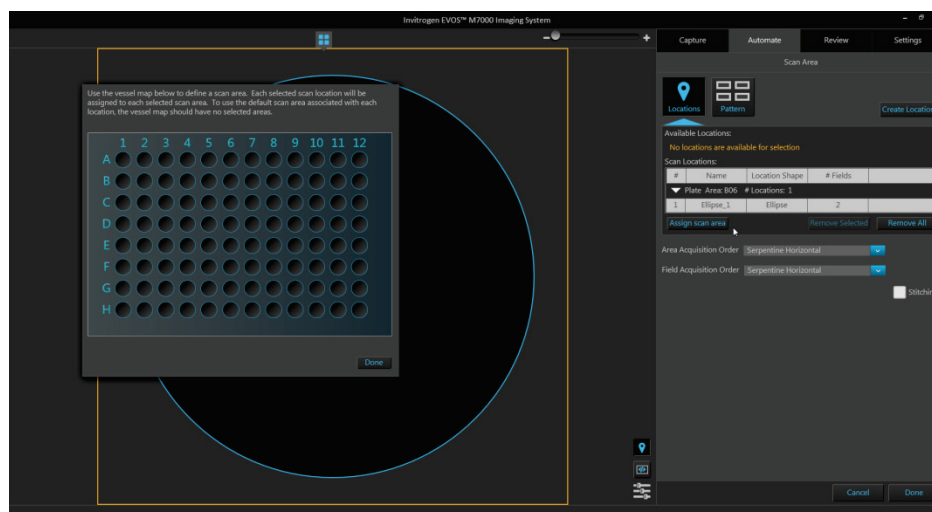

- When assigning scan areas, each selected scan location (i.e., highlighted in Scan Locations table) is assigned to each selected scan area.  
If no location is selected in the Scan Locations table, all scan locations listed in the table are assigned to each selected scan area.  
If the Vessel map contains no selected scan areas, the scan protocol uses the default scan area associated with each scan location.



- To define scan areas in the Vessel map:

- **Click** on a single area (well, chamber, or dish) to select it. Selected area will be displayed in blue.

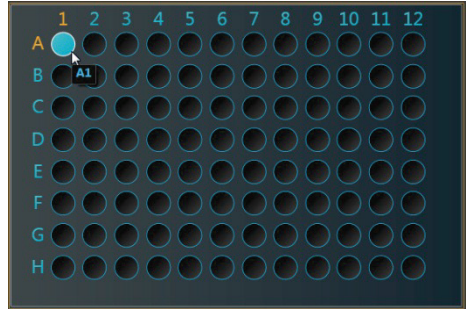

- **Ctrl-click** to select multiple areas individually. Selected areas will be displayed in blue.

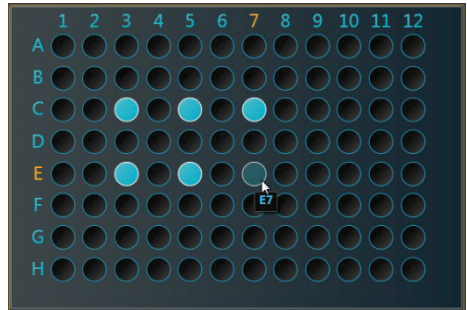

- **Click-drag** to select multiple areas as a single block on the Vessel map.

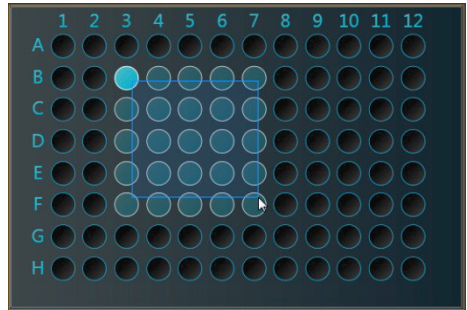

- **Ctrl-click-drag** to select multiple blocks on the Vessel map.

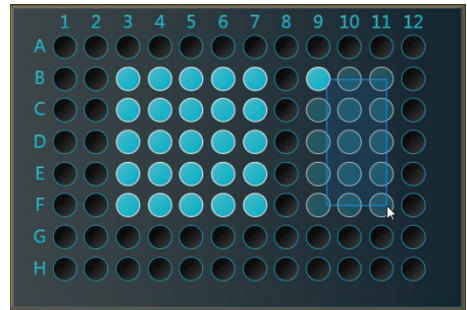

- To unselect scan areas:
  - To unselect a single area, Ctrl-click the area you want to unselect.
  - To unselect all areas, click on any region on the Vessel map that is not selectable (i.e., not a well, chamber, or dish).
- Click **Done** to close the Vessel map and exit the area selection mode.



- ⑤ **Scan Pattern:** Opens the **Scan Pattern** tool, which allows you to define the capture regions for the scan protocol as a pattern based on defined parameters.



- You can define the scan pattern as a matrix (X fields wide × Y fields high) or as a percentage of area covered by scan fields, counted either from the center or from the edges.

In the following example, the capture region has been defined as a matrix of 5 fields wide × 3 fields high.

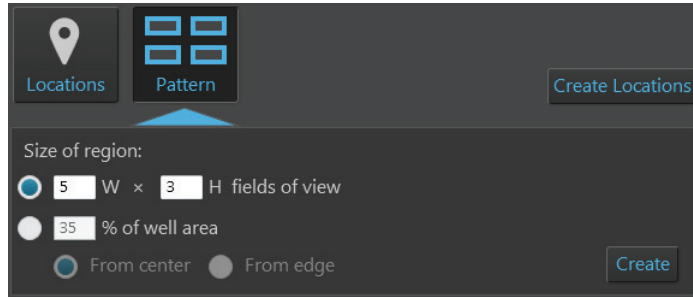

- As you define the parameters, the Area View displays a preview of the selected fields.

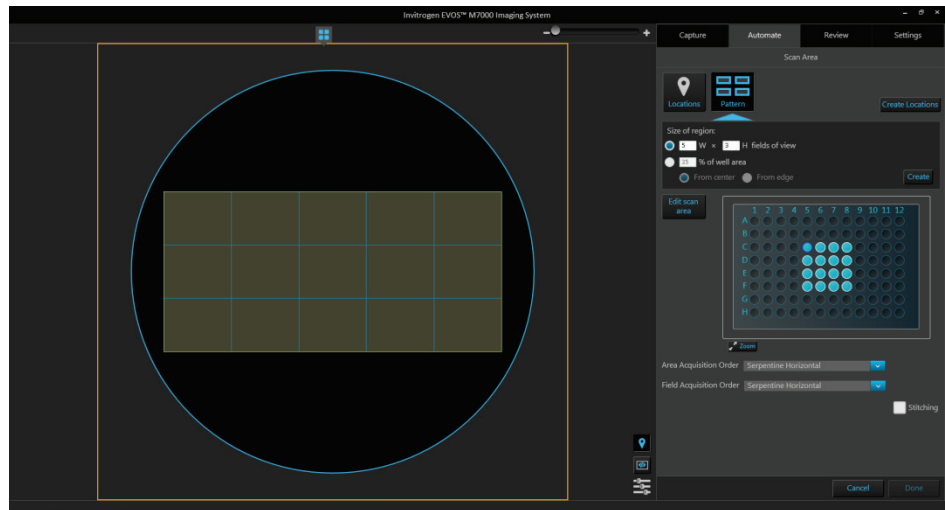

- To define the capture region as a matrix, select **W × H fields of view**, then enter the desired dimensions into the corresponding text boxes. You can only enter integers.

In this example, the capture region is defined as a pattern of 5 fields wide × 3 fields high.

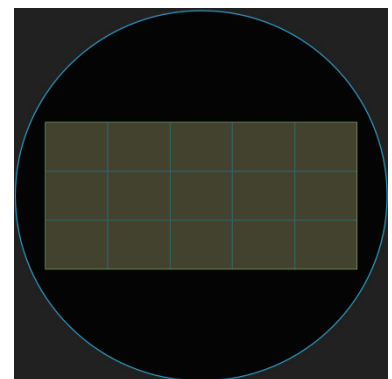

- To define the capture region as a percentage of area covered by scan fields, select **% of well area**, enter the desired value (an integer between 1 and 100) into the text box, then select **From center** or **From edge**.

In this example, the capture region is defined as 50% of well area covered by the scan fields, counted from the edge.

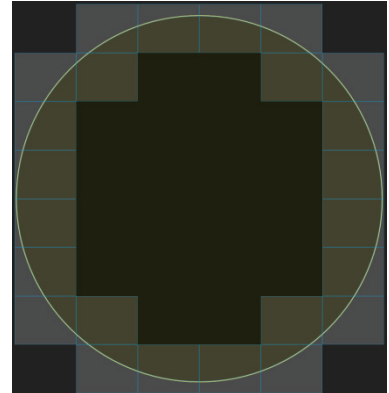

In this example, the capture region is defined as 50% of well area, counted from the center.

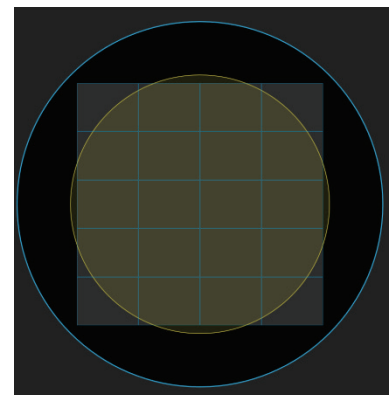

- When you are finished defining the parameters for the capture pattern, click **Create**.

- ⑥ **Create Locations:** Open the **Locations** tool (page 134), which allows you to create new locations for the scan protocol.

**Create Locations**

Using the **Locations** tool, define the locations as described (page 135), then navigate back to the **Automate tab ▶ Scan Locations**.

Newly created locations will be listed in the Available Locations table.

- ⑦ **Edit scan area:** When using the Scan Pattern tool, it allows you to specify the areas you want to capture by selecting the corresponding areas on the **Vessel map**.

Edit scan area

- Click **Edit scan area** to enable area selection on the Vessel map. Edit scan area button changes to **Done** button and the Vessel map becomes active.

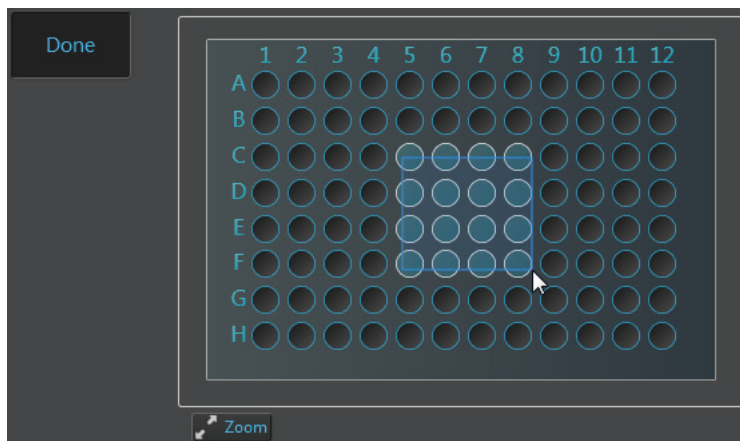

- To define scan areas in the Vessel map, follow the same procedure as described for the Assign scan area (page 165).
- If you want to view a larger version of the Vessel map, click the **Zoom button**. The larger map displays the same content as the smaller vessel map and behaves the same way.

Zoom

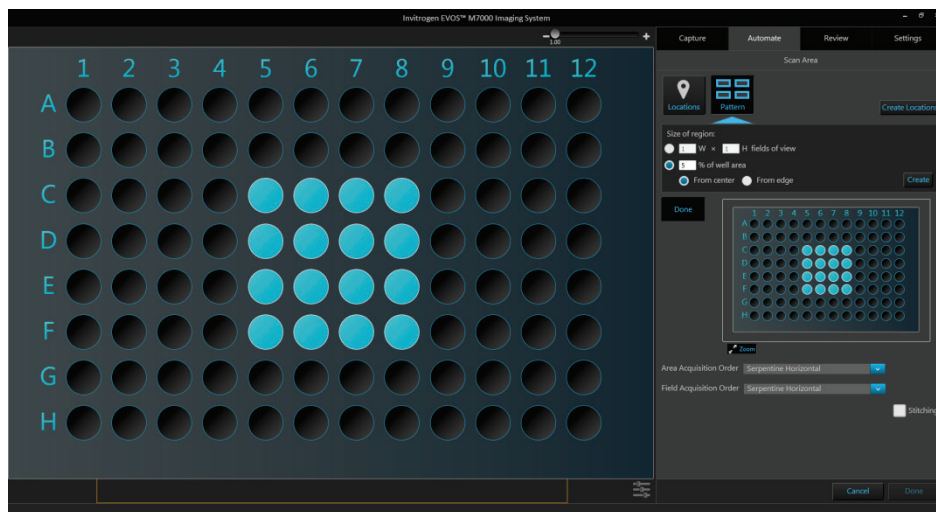

- When in the **edit mode** (i.e., **Edit scan area** button is clicked), clicking on an area in the larger map selects the corresponding area in the smaller map and marks it for the scan protocol.
- Clicking the zoom button again closes the zoom window.
- When finished defining the scan areas, click **Done** to exit the selection mode.

- ⑧ **Vessel map:** Represents the vessel container (vessel + vessel holder) in use. In the **Automate tab ► Scan Area** panel, the Vessel map is used to select specific areas for the automated scan protocol.
- To select an area (well, chamber, or dish) for the scan protocol, click **Edit scan area**, then click on the corresponding area on the Vessel map (page 168). A blue fill indicates that the area has been selected for the scan protocol.
  - The scan area shown in the Viewing area is indicated with a dark blue circle on the Vessel map. Areas that are not active have white circles.
  - In the example below, A1, A2, B1, and B2 wells have been selected for the scan protocol. A1 is the active scan area (with dark blue frame), while the inactive wells (A2, B1, B2) display white frames. The Area View shows the active well A1.

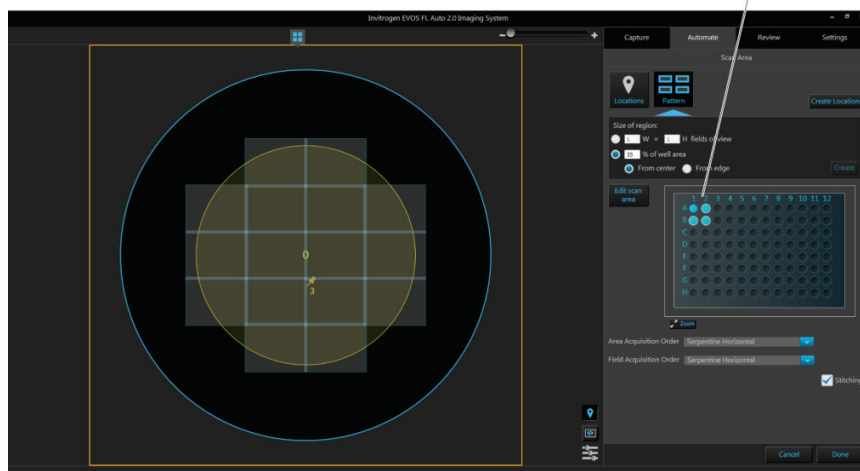
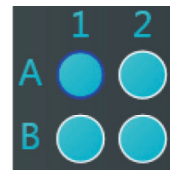

- ⑨ **Area Acquisition Order:** Allows you specify the order in which the selected areas are captured in the scan protocol. Available options are:

- **Serpentine Horizontal**
- **Serpentine Vertical**
- **Random Selection**

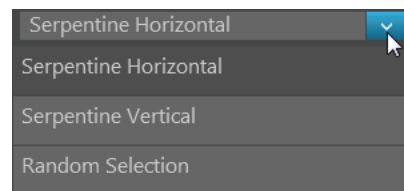

- ⑩ **Field Acquisition Order:** Allows you specify the order in which the fields are captured in each area selected for the scan protocol. Available options are:

- **Spiral Outward Counterclockwise**
- **Spiral inward Clockwise**
- **Serpentine Horizontal**
- **Serpentine Vertical**
- **Random Selection**

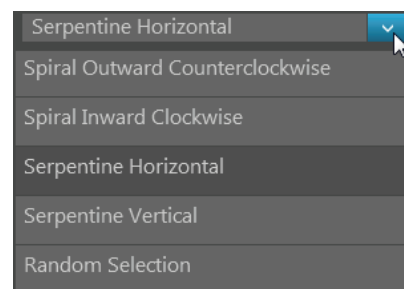

- ⑪ **Stitching:** Applies an overlap when assembling captured images into a mosaic image of the scan area, which allows you to visualize objects in the sample that cross fields.

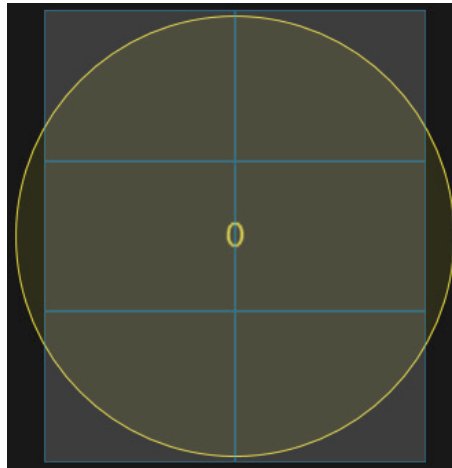

Stitching off

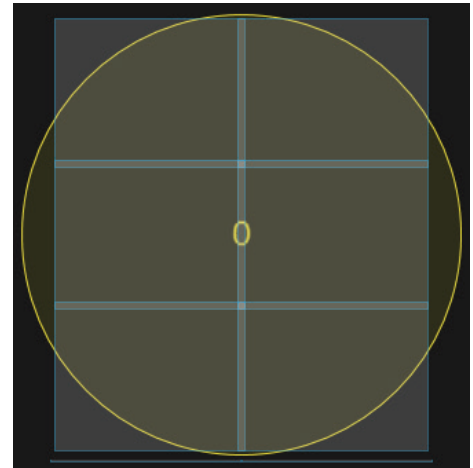

Stitching on

- ⑫ **Toggle locations display:** Switches the display of locations (defined with the Location tool) in Area View on and off.



Field borders are on



Field borders are off

- ⑬ **Toggle field borders:** Switches the borders around captured fields in Area View on and off. This option is not available in Field View.



Field borders are on



Field borders are off

- When field borders are turned on, all captured fields in Area View are displayed with blue borders around them.
- Currently selected field, whether captured or not, is displayed with an orange border, which cannot be hidden.



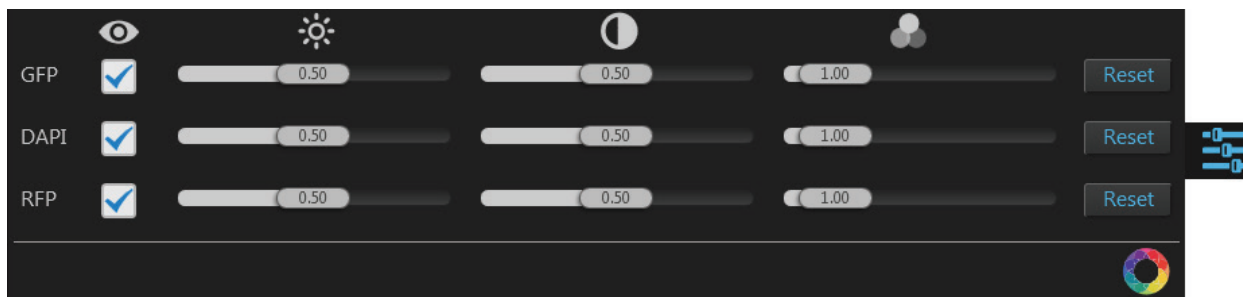

- ⑭ **Image display settings:** Opens the Image display settings window, which allows you to adjust image display parameters (brightness, contrast, gamma) for the Viewing Area. Clicking the button again closes the window.



**Note:** Adjustments made to Image display settings only affect how the image is displayed in the Viewing Area; they do not change how the image is captured.

- **Visible Channels** : Visible channels are the channels selected for display in the Viewing area. They are selected using the **Toggle channel display** checkbox located on the top left corner of the corresponding **Light source** button (page 143).

**Note:** The controls for image display settings are contextual; only the controls for the visible channels will be available. In the example above, only the controls for the GFP, DAPI, and RFP channels are displayed.

- **Brightness** , **Contrast** , and **Gamma**  parameters for each of the selected channels are adjusted using the corresponding sliders.
- **Reset** button resets the **Brightness**, **Contrast**, and **Gamma** parameters to their default values.
- **Toggle image color display:** Option to display images in pseudocolor or in grayscale in the Viewing area. By default, color display is on. 

When on, images are displayed in default pseudocolor corresponding to the channel in which they were captured. You can change the default pseudocolor in the Settings tab (page 192).

When off, images are displayed in grayscale.

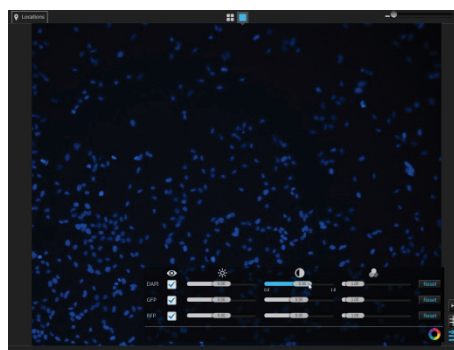

Color display is on

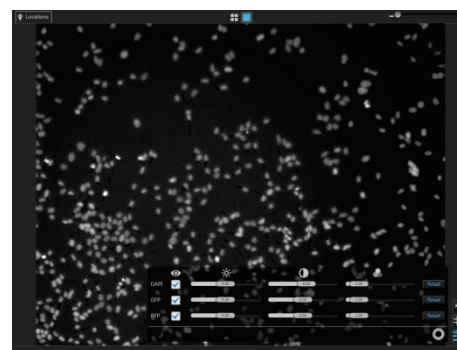

Color display is off

## AutoFocus and Z Stacks

AutoFocus and Z Stacks panel allows you to configure the autofocus options and determine the Z-Stack settings for the scan protocol.

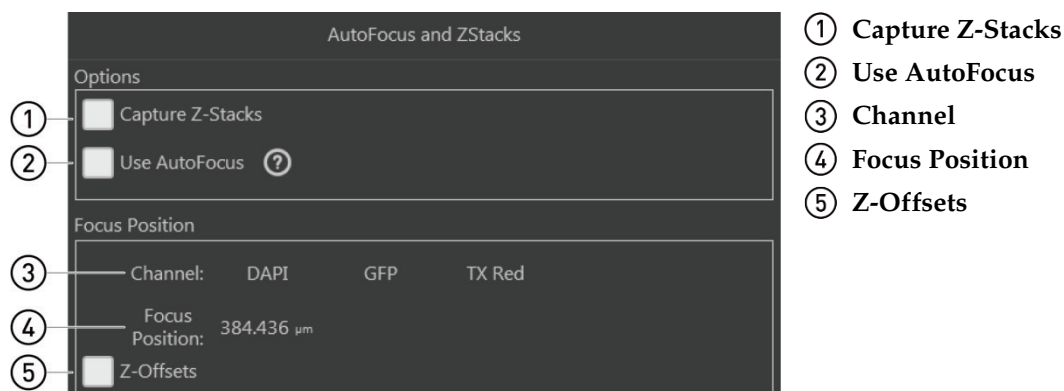

---

**Note:** The options available on this panel are contextual; the controls that are displayed depend on the selections made in this panel or elsewhere in the Automate tab. Objects and controls that are not available as a function in a particular context are not shown in the panel.

---

**Note:** Click on the **View Help Content** icon to open the Help window, which provides EVOS™ M7000 Imaging System Help. 

---

## AutoFocus and Z Stacks controls

- ① **Capture Z-Stacks:** Allows you to capture a series of images at various focal planes along the z-axis within the sample.  
Checking this option reveals the controls for **Z-Stack Settings** (page 173).
- ② **Use AutoFocus:** Allows you configure the autofocus method and set the autofocus frequency to use during automated scan.  
Checking this option reveals the controls for **AutoFocus Settings** (page 176).
- ③ **Channel:** Indicates the channels selected for capture in scan protocol, and allows you set the default focus position.  
Depending on the context, **Channel** displays channel selection buttons for the Default Focus Position and the Z-Offsets.
- ④ **Focus Position:** Indicates the active z-stage position (i.e., the position of the focal plane along the z-axis) for the selected channel (page 178).
- ⑤ **Z-Offsets:** Allows you to specify the focus position in each channel relative to the focus position in other channels when the fluorescent markers in different channels are in different focal planes (page 178).  
This option is not available when the scan protocol is set to capture images in a single channel.

## Z-Stack Settings

Z-Stacking allows you to capture multiple images along the z-axis based on your specifications during the automated scan protocol.

Images captured for the z-stack can be used to create a Z-Stack Projection. Z-Stack Projection is a digital image processing technique that combines multiple images taken at different focal planes to generate an image with a greater depth of field than any of the individual source images.

The settings for the Z-Stack procedure are configured in the Z-Stack Settings window in the Capture tab (**Capture tab ► Capture Z-Stack**, page 152).

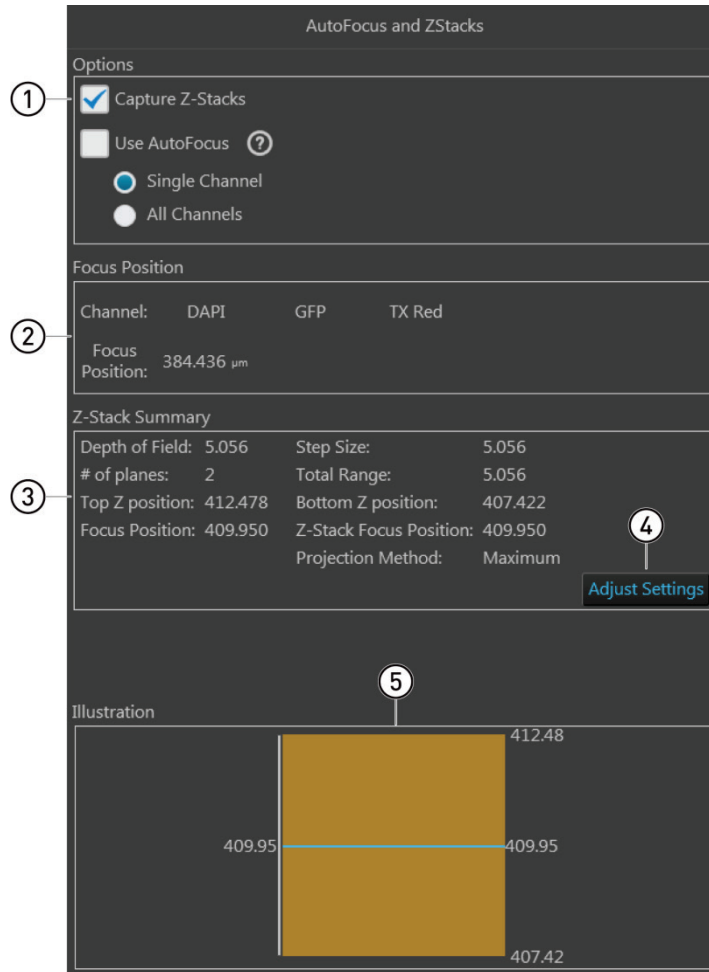

① **Capture Z-Stacks** (page 174)

④ **Adjust Settings** (page 174)

② **Focus Position** (page 174)

⑤ **Illustration** (page 175)

③ **Z-Stack Summary** (page 174)

---

**Note:** When the **Capture Z-Stacks** option is checked, the Z-Offsets option is not available as one of the Focus Position controls and the Z-Offsets that have been previously set are not preserved.

---

**Note:** Click on the **View Help Content** icon to open the Help window, which provides EVOS™ M7000 Imaging System Help.





## Z-Stack Settings controls

- ① **Capture Z-Stacks:** Allows you to capture z-stack images based on your specifications during your automated scan protocol.

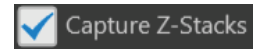

When the **Capture Z-Stacks** option is checked, the AutoFocus and Z Stacks panel displays the Z-Stack Summary, the Adjust Settings button, and Illustration.

- ② **Focus Position:** Indicates the position of the current focal plane along the z-axis for the selected channel, which is used as a reference point when defining the different focal planes captured for the Z-Stacks.

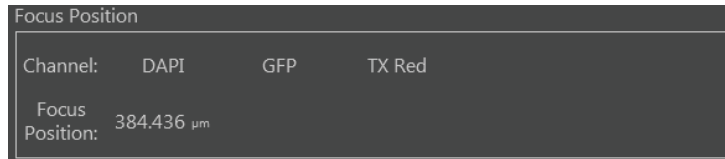

- ③ **Z-Stack Summary:** Provides a summary of the Z-Stack Settings that were set up in the Capture tab (**Capture tab ► Capture Z-Stack**, page 152).

The summary includes information on depth of field, step size, number of planes, total range of the z-stack, top and bottom z-positions, default focus position of the selected channel, and the z-stack focus position.

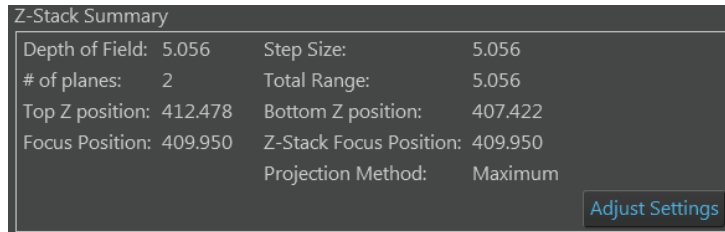

- ④ **Adjust Settings:** Opens the Z-Stack Settings window in the Capture tab, which allows you to modify the z-stack settings for the scan protocol (see "Capture Z-Stack", page 152).

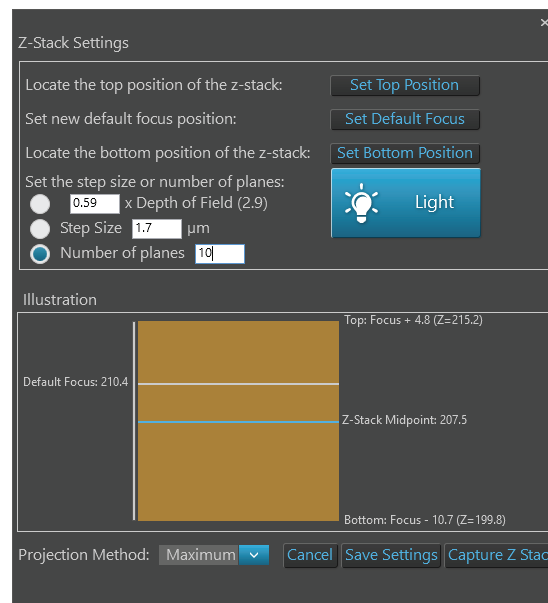

- ⑤ **Illustration:** Graphically demonstrates the Z-Stack Settings. Illustration is available only if Capture Z-Stacks option is selected (page 172).

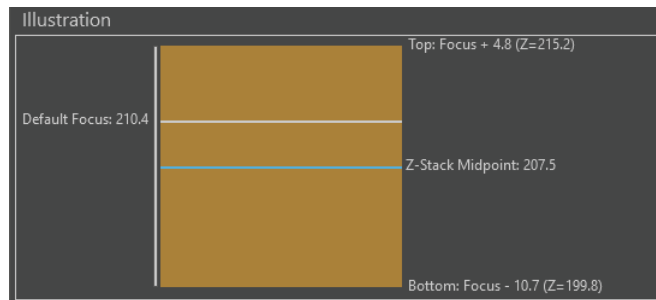

- The Z-Stack Midpoint is represented by a blue line. Half of the images captured for the z-stack are above this position and half are below it.
- The default focus position is represented by a white line.
- The orange rectangle represents the z-stack depth. It is the product of step size and number of planes.
- The positions of the bottom and the top focus positions and the position of the Z-Stack Focus are indicated in  $\mu\text{m}$  next to the orange rectangle representing the z-stack depth.

## AutoFocus Settings

Autofocus performance depends on the z-information contained within a vessel and vessel holder combination. When the system is properly calibrated for the selected vessel, autofocus is able to use the dimensions used during the vessel creation to find the optimal focal plane.

During automated scan, if the autofocus is unable to find the focal plane using a small range, it extends the range within which it searches for focal plane.

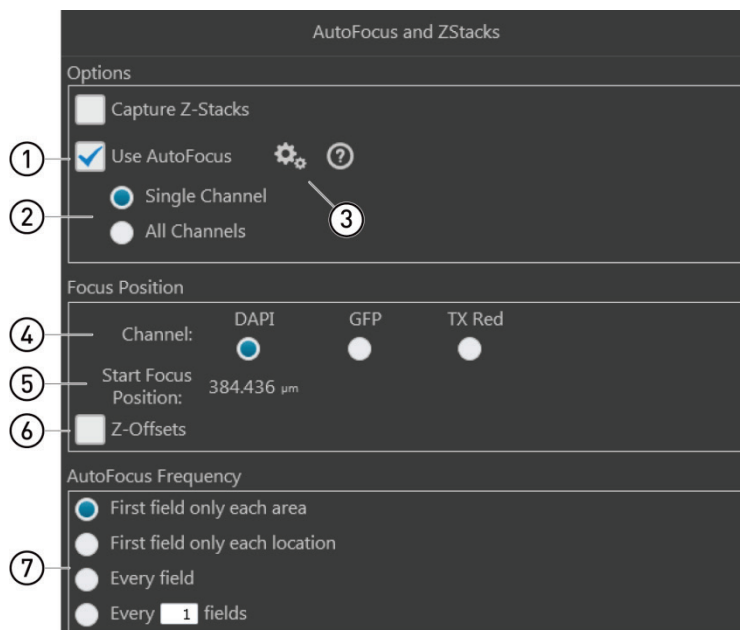

- ① Use AutoFocus (page 177)
- ② Single Channel/All Channels (page 177)
- ③ Configure AutoFocus Method (page 177)
- ④ Channel (page 178)
- ⑤ Start Focus Position (page 178)
- ⑥ Z-Offsets (page 178)
- ⑦ AutoFocus Frequency (page 179)

**Note:** Click on the **View Help Content** icon to open the Help window, which provides EVOS™ M7000 Imaging System Help.



## AutoFocus Settings controls

① **Use AutoFocus:** Reveals the controls for setting autofocus options for the scan protocol.

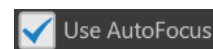

② **Single Channel/All Channels:** Option to run the autofocus in a single channel or in all channels selected for the scan.

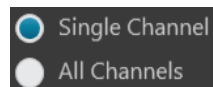

- When **Single Channel** is selected, autofocus is run in a single channel. This option preserves the Z-Offsets between the channels.
- By default, the last channel used for imaging or viewing a live image is selected for single channel autofocus. You can change the autofocus channel using the **Channel** radio buttons (page 178).
- When **All Channels** is selected, autofocus is run separately in all channels that were selected in the Hardware panel (page 158). This option does not preserve the Z-Offsets between channels.

③ **Configure AutoFocus Method:** Reveals the controls to configure the autofocus method for each channel selected for the scan protocol.

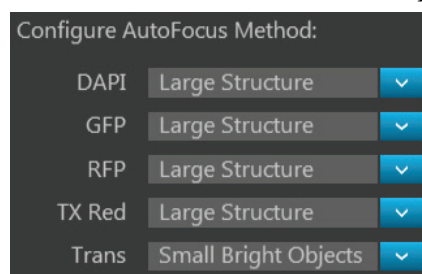

Available options are:

- **Fluorescence Optimized:** The focal plane is derived from the highest ratio between detailed, high-contrast objects against the background. This option is recommended for fluorescence imaging.
- **Transmitted Optimized:** The optimal focal plane is derived through statistics-based edge detection over 9 different regions to determine the highest ratio of edge-to-background. This option is recommended for transmitted-light imaging.
- **Small Structure:** This method computes the energy according to the size of image features and can measure the presence/absence of small image features. Choose this option when capturing samples that have many fine, hair-like structures (e.g., filaments or structural stains).
- **Large Structure:** This method is statistics-based and looks for large changes in image content as parts of the image go in and out of focus. Choose this option when your sample contains large structures (e.g., whole cell stains).
- **Small Bright Objects:** This method looks for changes in brightness at the center of the cell and optimizes focus on cells that have a bright center with a dark surround area. Choose this option to capture samples with localized staining (e.g., nuclei).

After selecting the autofocus method, click **Close** to return to the AutoFocus and Z Stacks panel.

---

**Note:** The effectiveness of the autofocus method depends on the plate type, sample type, biomarker intensity, magnification, and channel. It may be necessary to use different autofocus methods for different channels. This ensures that the best autofocus method is used for the relevant biology.

---

- ④ **Channel:** Allows you to select the channel in which to run the autofocus during the automated scan when the **Single Channel** option is selected.
  - Only the channels that have been selected for the automated scan protocol in the Hardware panel will be available for selection.
  - In the example below, DAPI channel has been selected for the autofocus procedure during the scan protocol.

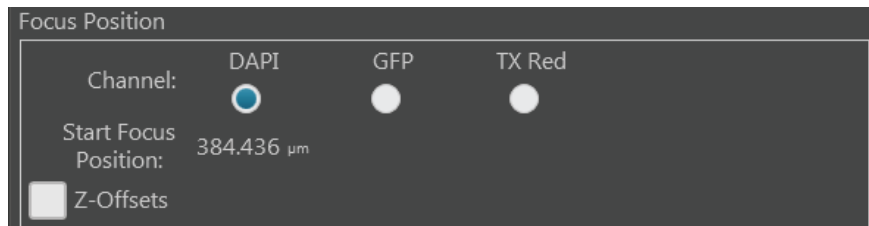

- ⑤ **Start Focus Position:** Indicates the currently active z-stage position (i.e., position of the current focal plane along the z-axis) for the selected channel.
  - The Start Focus Position is used as starting point around which the autofocus algorithm searches for optimal focus.
  - You can only select a single channel for the Start Focus Position.
  - When Z-Offsets option is checked, Start Focus Position is used as reference point against which the focus position in other channels is set.
- ⑥ **Z-Offsets:** Allows you to specify the focus position in each channel relative to the focus position in other channels. Setting the correct Z-Offsets is especially important when the fluorescent markers in different channels are in different focal planes.

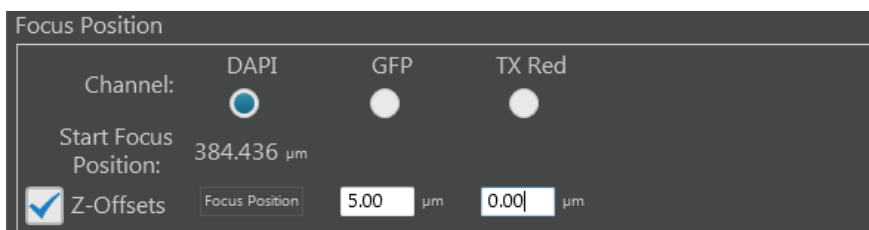

- The Z-distance difference between channels is expressed as an offset from the Start Focus Position in the reference channel.
- You can enter both positive and negative values in  $\mu\text{m}$  for the Z-Offsets. In the example above, the reference start focus position is set to 384.44  $\mu\text{m}$  in the DAPI channel, while the Z-Offset for the GFP channel is 5.00  $\mu\text{m}$ . Therefore, the autofocus algorithm will use 389.44  $\mu\text{m}$  as the default focus position for the GFP channel.
- If the autofocus algorithm is configured to run on a single channel (page 177), the current Z-distance differences between channels will be preserved as if the Z-Offsets have been locked (page 146).
- If the autofocus algorithm is configured to run on all channels (page 177), then the autofocus run in one channel will not affect the Z-distances of the other channels as if the Z-Offsets have been unlocked (page 146).
- The **Z-Offsets** option is not available when the **Capture Z-Stacks** option has been selected (page 173).

---

**Note:** Consider a scenario where the initial Z-positions of the DAPI and GFP channels are 50  $\mu\text{m}$  and 80  $\mu\text{m}$ , respectively. The autofocus is run from the DAPI channel and finds the best focal plane at a Z-position of 60  $\mu\text{m}$ .

If the autofocus is selected to run from a single channel, then the Z-Offsets will be locked, and the GFP channel will be focused to a Z-position of 90  $\mu\text{m}$ .

If the autofocus is run from all channels, then the Z-Offsets will not be locked, and the autofocus algorithm will find the best focal plane for the GFP channel independently of the DAPI channel.

---

- ⑦ **AutoFocus Frequency:** Allows you to specify which fields in a scan area are used for autofocus during the automated scan protocol. Specifying fewer fields per scan area for autofocus reduces the overall scan times.

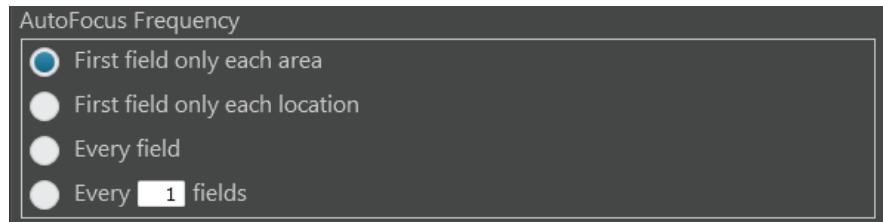

Available options for AutoFocus Frequency are:

- **First field only each area:** Performs the autofocus operation only on the first field of each scan area. No further autofocus is performed on subsequent fields in the scan area. The focus position obtained on the first field is used for the remaining fields in the scan area.
- **First field only each location:** Performs the autofocus operation only on the first field of each location in every scan area. No further autofocus is performed on subsequent fields..
- **Every field:** Performs the autofocus operation on every field of the scan area.
- **Every <X> fields:** Allows you to specify the distance between fields in each scan area before the autofocus is triggered.

The distance between fields is expressed as “unit fields” (equivalent to a field of view as determined by the objective used); it is not determined by the order in which the fields are collected.

For example, if you want to autofocus every 3 fields, autofocus will only occur when the stage is three fields away from another autofocused field. If the stage is less than three fields away, autofocus will not occur.

## Time Lapse and Incubator

Time Lapse and Incubator panel gives you the option of running your automated scan protocol over a time period, with or without the use of the EVOS™ Onstage Incubator, where the selected fields are captured at given intervals based on your specifications. The images captured in a time lapse scan protocol can then be compiled into a video sequence.

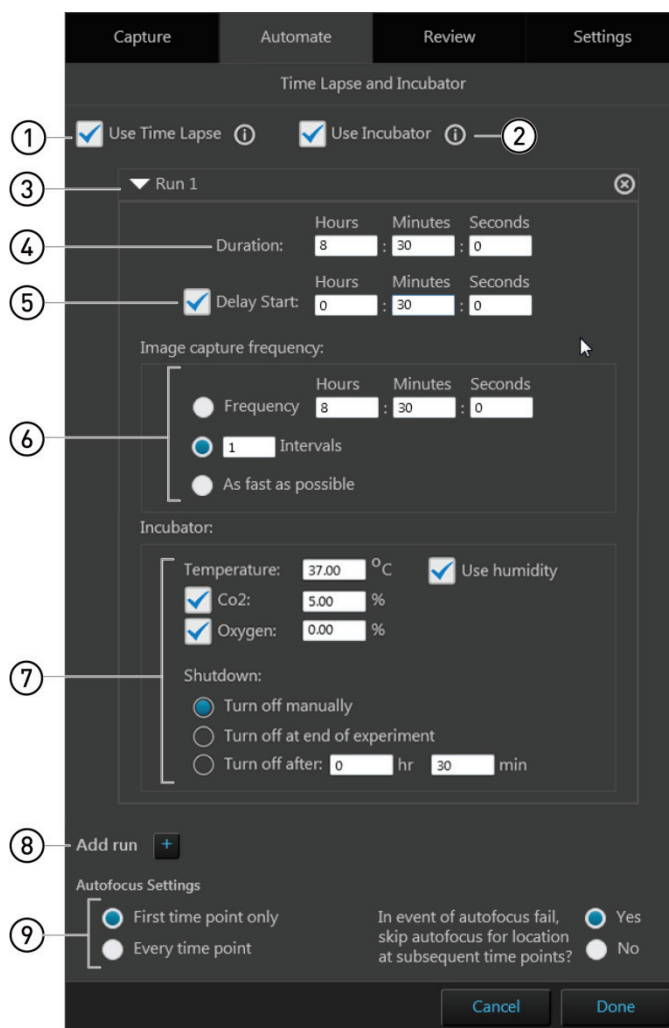

- ① Use Time Lapse (page 181)
- ② Use Incubator (page 181)
- ③ Run (page 182)
- ④ Duration (page 182)
- ⑤ Delay Start (page 182)
- ⑥ Image capture frequency (page 183)
- ⑦ Incubator (page 184)
- ⑧ Add run (page 184)
- ⑨ Autofocus Settings (page 185)

**Note:** The options on this panel are contextual. Objects and controls that are not available as a function in a specific context are not shown in the panel.

**Note:** Click on the **View Help Content** icon to open the Help window, which provides EVOS™ M7000 Imaging System Help.



## Time Lapse and Incubator controls

- ① **Use Time Lapse:** Allows you to create time lapse routines to capture individual images at given intervals over a time period based on your specifications.

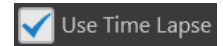

- Checking the **Use Time Lapse** box enables all other controls in this panel, allowing you to set the specific options for your time lapse routine (e.g., imaging frequency, use of the incubator etc.).

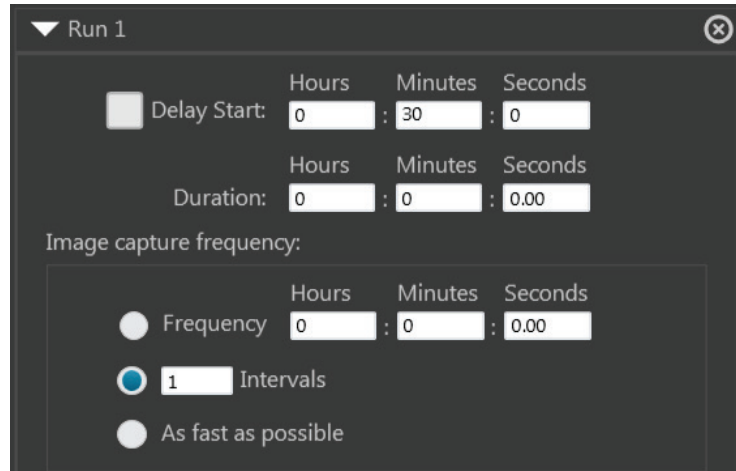

- A time lapse routine can be divided into individual “runs”, which allow for different imaging frequency, duration, and incubator settings (see “Run”, below).
  - To add additional runs to your time lapse routine, click the **Add run** button (page 184).
  - The fields and locations to be captured during a time lapse experiment are selected in the **Scan Area** panel (page 159).
  - The autofocus options for the time lapse routine are set in the **AutoFocus and Z Stacks** panel (page 172).
  - The captured images are stored with time lapse information in their headers and can be stitched together into a video.
- ② **Use Incubator:** Enables the use the EVOS™ Onstage Incubator your time lapse experiments. This option is available only when the EVOS™ Onstage Incubator is connected to the EVOS™ M7000 Imaging System.

When checked, **Use Incubator** option reveals the controls for configuring the incubator settings (see “Incubator”, page 184).

---

**Note:** The EVOS™ Onstage Incubator (Cat. No. AMC1000) is an optional accessory that enables the incubation of cells on the automatic X-Y stage, allowing the capture of images from the same sample over long periods of time and the recording of time lapse movies.

---



- ③ **Run:** Contains the controls for the corresponding run.

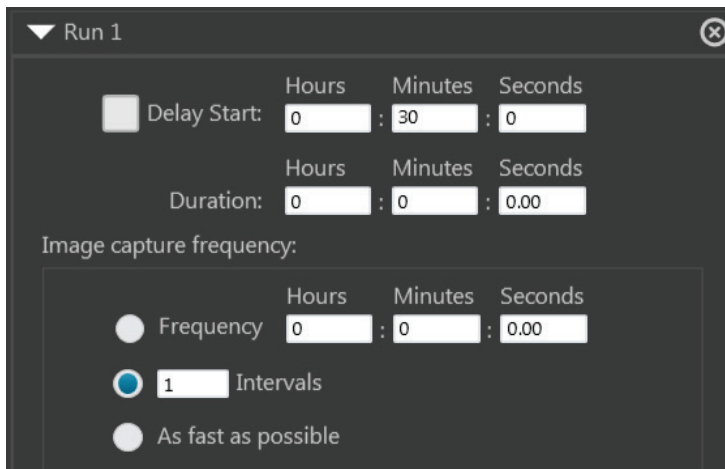

- The options available in this area are contextual and depend on the selections made for **Use Time Lapse** and **Use Incubator**.
- Click the **collapse/expand** button to hide the controls for the run. Click the button again to expand the controls.
- To add additional runs to your time lapse routine, click the **Add run** button (page 184).
- If there is more than one run in the time lapse routine, each run has its own set of controls that are similarly collapsible/expandable.
- Click the **Delete Run** button to delete a run and remove it from the panel.

- ④ **Duration:** Allows you to specify the duration of the corresponding run in the time lapse routine.

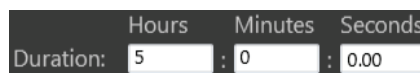

- Enter the desired values for the duration of the run into the corresponding **Hours**, **Minutes**, and **Seconds** fields.

- ⑤ **Delay Start:** Allows you to postpone image capture for the corresponding run of the time lapse routine and specify the duration of the delay.

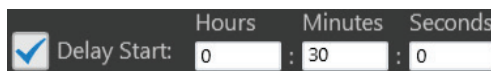

- Enter the desired values for the delay into the corresponding **Hours**, **Minutes**, and **Seconds** fields.
- When the Delay Start option is not selected, image capture starts immediately after the time lapse experiment is initiated.
- By default the Delay Start option is deselected, with 0 hours entered for the duration. After this feature has been used once, the most recent delay period entered is used as the default value.

- ⑥ **Image capture frequency:** Sets the frequency with which the image sets are captured for the corresponding run in the time lapse routine. The fields and scan areas are captured in the order specified in the **Scan Area** panel (page 169).

Image capture frequency:

Frequency    Hours: 0    Minutes: 5    Seconds: 0.00  
 12 Intervals  
 As fast as possible

Available options for image capture frequency are:

- Frequency:** Determines the time period that must elapse before a new set of images are captured. Note that the initial set of images is captured at time point 0.

For example, if your run duration is 1 hour and you have entered 12 minutes for image capture frequency, the instrument captures one set of images every 12 minutes starting at time point 0 for a total of 6 image sets (60 minutes/12 minutes per image set plus the initial image set at time point 0).
- Intervals:** Determines the total number of time intervals between captured image sets for a given run duration. Note that the initial set of images is captured at time point 0.

For example, if your run duration is 1 hour and you have specified 5 Intervals, the instrument captures a total of 6 image sets 12 minutes apart (60 minutes/5 intervals plus the initial image set at time point 0).
- As fast as possible:** Captures a new set of images immediately after completing the capture of the previous set without any delay between the image sets.

Note that the speed with which the images are captured depends on your specifications for the scan protocol such as the autofocus frequency and exposure settings.

When this option is selected, the instrument captures all selected fields in each scan area in the order specified, and then repeats the image capture process without any delay, starting with the first field in the first area for the duration of the run.

- ⑦ **Incubator:** Determines the incubation parameters (i.e., culture conditions) and the shutdown method for the EVOS™ Onstage Incubator.

Incubator:

Temperature: 37.00 °C  Use humidity

Co2: 5.00 %



Oxygen: 0.00 %

Shutdown:

Turn off manually

Turn off at end of experiment

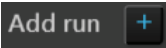
Turn off after: 0 hr 30 min

- The incubation parameters are set separately for each run in the time lapse routine.
  - **Temperature:** Sets the incubator temperature (ambient to 40°C).
  - **CO<sub>2</sub>:** Sets the CO<sub>2</sub> level (0% to 20%).
  - **Oxygen:** Sets the oxygen level (0% to 20%).
  - **Use humidity:** Enables the use of humidified atmosphere in the incubation chamber.
  - **Shutdown:** Allows you to select the shutdown method for the EVOS™ Onstage Incubator at the end of your time lapse routine.
    - **Turn off manually:** The incubator remains on until the **Use Incubator** option is manually deselected.
    - **Turn off at the end of experiment:** Heat, humidity, and the flow of gas are automatically turned off at the end of the experiment.
    - **Turn off after:** Enter the time period in **hours** and **minutes** that must elapse before the heat, humidity, and the flow of gas are automatically turned off.
- ⑧ **Add run:** Adds a new run to the time lapse routine. 
- Clicking the **Add run** button adds a new set of run controls to the panel, which are identical to the existing run controls. This allows you set the parameters for each run (delay start, duration, capture frequency, and incubator settings) independently for each run.
  - The runs are performed in chronological order, beginning with Run 1 and ending with Run N.
  - You can remove a run from the time lapse routine by clicking the corresponding **Delete Run** button .

- ⑨ **Autofocus Settings:** Allows you to set the autofocus frequency and autofocus fail options for the time lapse routine only.

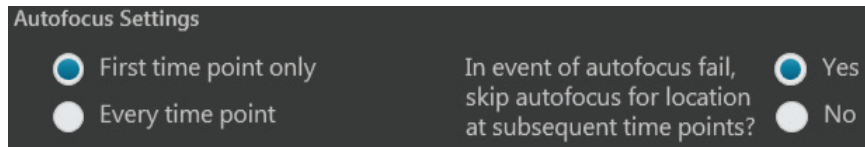

- **First time point only:** Performs the autofocus procedure only once at the first time point of the run before proceeding with image capture.
- **Every time point:** Performs the autofocus procedure at every time point of the run, ensuring that the sample is in focus for each image set captured.
- **Autofocus fail options:** Selecting **Yes** causes the instrument to skip the autofocus procedure at locations where no optimal focal plane was found at subsequent time points.

Selecting **No** ensures that the autofocus is run at each selected autofocus location every time regardless of previous autofocus failure.

---

**Note:** The Autofocus Settings options available in this panel apply only to the time lapse routine. Autofocus locations and method are determined separately in the AutoFocus and Z Stacks panel (page 176).

---

## Image Save Settings

Image Save Settings panel allows you to assign a destination directory for your saved images and to specify the file types to save.

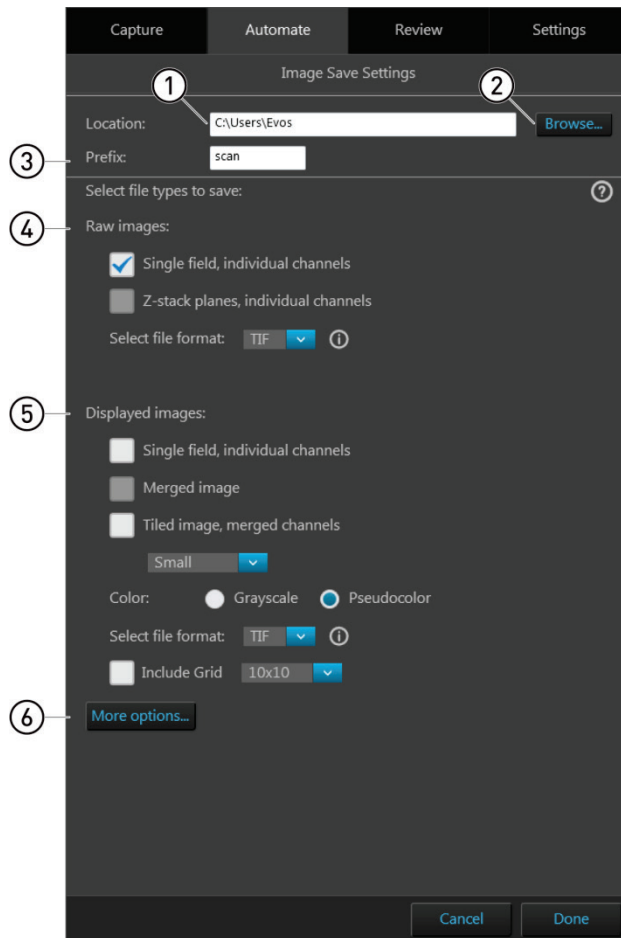

- ① **Location** (page 187)
- ② **Browse** (page 187)
- ③ **File name prefix** (page 187)
- ④ **Raw images** (page 188)
- ⑤ **Displayed images** (page 189)
- ⑥ **More options** (page 190)

**Note:** Click on the **View Help Content** icon to open the Help window, which provides EVOS™ M7000 Imaging System Help.



Position your pointer over the **Tooltip** icon without clicking it for additional information.



## Image Save Settings controls

- ① **Location:** Describes the location of the current folder or file.

Location:

- ② **Browse:** Opens the Select Folder window to assign a destination directory for your saved images.

The Select Folder window follows the standard Windows file navigation system.

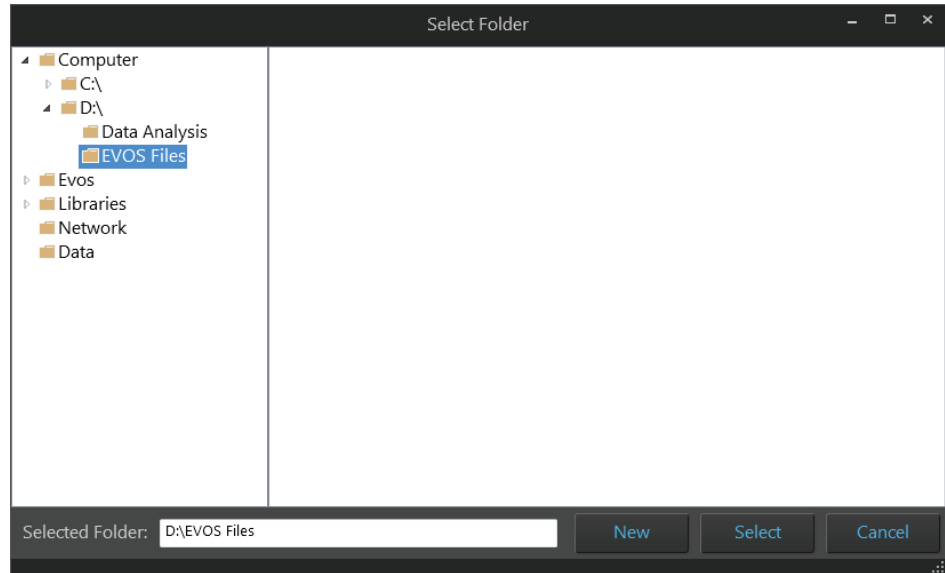

- **Selected folder:** Displays the location of the current folder.
- **New:** Creates a new folder in the current location.
- **Select:** Selects the current folder as the destination directory for your saved files. If the destination directory contains other files that could get overwritten, a warning message is displayed in the Select Folder window.

---

**Note:** We recommend that you save your captured images to an external hard drive.

---

- ③ **File name prefix:** Allows you to assign a prefix to the automatically generated file names when saving captured images.

Prefix:

The default prefix for images captured in an automated scan is “scan”.

---

**Note:** For more information on the file naming convention when saving, see “File naming convention”, page 191.

---

- ④ **Raw images:** Allows you to save images and image sets captured in individual channels as 16-bit Raw images. This is the recommended format for performing image analysis and quantitation (see “Raw vs. Displayed images”, page 125).

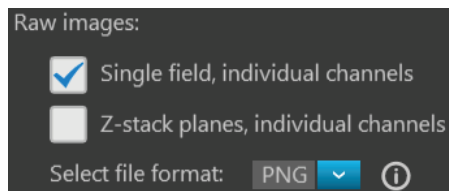

Available save options for Raw images are:

- **Single field, individual channels:** Saves images captured in each field and each channel individually.
- **Z-planes, individual channels:** Saves individual images captured along the z-axis as well as the z-stack projection for each field and channel.

Available file formats for Raw images are:

- **TIFF:** No image compression with either no loss in image quality (16-bit Raw) or reduced (8-bit) dynamic range (Microsoft-compatible TIFF).
- **PNG:** Medium image compression with no loss in image quality.
- **C01:** Thermo Fisher™ proprietary format. Only images captured by monochrome cameras may be saved in this format.
- **DIB:** Color corrects across devices for true viewing. Only images captured by monochrome cameras may be saved in this format.

---

**Note:** If you plan to analyze your images, save them in 16-bit TIFF Raw format. The 16-bit dynamic range is required for analysis, and there is additional information in the file headers, including OME data, that can be useful.

---

**Note:** When viewed on most standard image viewers, 16-bit images will appear very dark or almost totally black, especially if a low exposure setting was used. These images will either need to be converted for display or opened in a software application that allows viewing of 16-bit images.

---

- ⑤ **Displayed images:** Allows you to save images in a format that can be viewed in most image display applications. This is the recommended format for “prettiest” images (see “Raw vs. Displayed images”, page 125).

You can save displayed images in 24-bit pseudocolor (8-bit per RGB channel) or 16-bit grayscale, either individually from each channel or as a merged image.

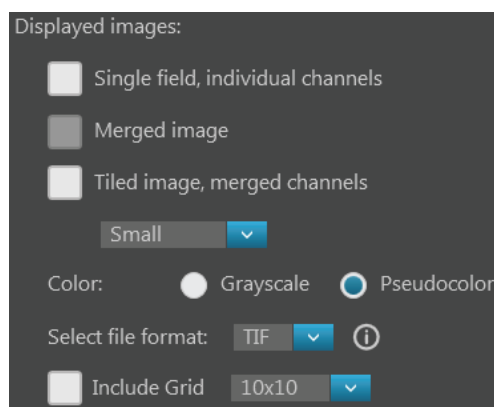

---

**Note:** While pseudocolors help differentiate the channels used in multi-channel overlays, grayscale images usually show more detail.

24-bit images (8-bit per RGB channel) are NOT recommended for image analysis as not all channels will display in many image analysis applications.

---

Available save options for displayed images are:

- **Single field, individual channels:** Saves images captured in each field and each channel individually in **Grayscale** (16-bit) or **Pseudocolor** (24-bit RGB; 8-bit per RGB channel).
- **Merged image:** Combines images of a field captured in different channels into a multicolor overlay and saves the image in 24-bit Pseudocolor (8-bit per RGB channel).
- **Tiled image, merged channels:** Merges the images captured in each channel and aligns them close together into a tiled format without applying a stitching algorithm. The resulting tiled image is not seamless, but this method is quicker than stitching and is often sufficient for most applications. You can create tiled images with the following dimensions:
  - **Small** (2000 × 2000 pixels)
  - **Medium** (4000 × 4000 pixels)
  - **Large** (10,000 × 10,000 pixels)
  - **Maximum** (26,000 × 26,000 pixels).

---

**Note:** If you are analyzing images that cross fields and the images are slightly misaligned, you might want to consider **stitching** the images (page 170). Stitching applies an algorithm to apply an overlap, and then removes the seam so you can visualize objects that cross fields. For more information about tiled and stitched images, see “Tiled, Stitched, and Merged images”, page 125.

---

Available file formats for raw images are:

- **TIFF:** No image compression with either no loss in image quality (16-bit Raw) or reduced (8-bit) dynamic range (Microsoft-compatible TIFF).
- **PNG:** Medium image compression with no loss in image quality.
- **JPEG:** High image compression with little loss in image quality; good for sharing.

**Include Grid** option superimposes a grid on the displayed images with the following options for grid size (in pixels):

**Auto, 10 × 10, 50 × 50, 100 × 100, 200 × 200, and 500 × 500.**

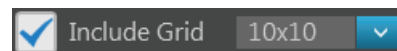



- ⑥ **More options:** Displays the full menu of save options in a convenient table format, allowing you to save your images in various formats simultaneously.

More options...

Select file types to save: ?

	Raw images (saves each channel individually)	Displayed image-individual channel	Displayed image-merged view
Single field	<input checked="" type="checkbox"/>	<input checked="" type="checkbox"/>	<input type="checkbox"/>
Z-Stack planes	<input type="checkbox"/>	<input type="checkbox"/>	<input type="checkbox"/>
Tiled images	<input type="checkbox"/>	<input type="checkbox"/> Small <span>▼</span>	<input checked="" type="checkbox"/> Small <span>▼</span>

TIF ▼ ⓘ

Color:  Grayscale  Pseudocolor

---

TIF ▼ ⓘ

---

Include Grid 10x10 ▼

Fewer options...

**Note:** We recommend saving captured images as both Raw and Displayed images to preserve the option of using the Raw images in downstream image analysis and quantitation, and the Displayed images for instances where “prettier” images are required. For more information on Raw and Displayed images, see “Raw vs. Displayed images”, page 125.

**Note:** For more information about when to use tiled or stitched images, see “Tiled, Stitched, and Merged images”, page 125.

## File naming convention

Files are saved using the following file naming convention:

**<Prefix>\_Image format\_Time point\_Z-plane\_Grid\_Row\_Column\_Field\_Channel\_File type**

where:

- **<Prefix>:** User defined prefix that is assigned to the automatically generated default file name.  
By default, the prefix is “image” for images captured manually in the Capture tab, and “scan” for images captured automatically in the Automate tab.
- **Image format:** Refers to the format in which the images was saved (R = Raw, D = Displayed, M = Merged).
- **Time point:** Describes the time point at which the image was captured and has the format p0, p1, p2... etc.  
For manually captured images, the time point is set to “p0”.
- **Z-plane:** Describes the plane in the z-axis where the image was captured and has the format z0, z1, z2...etc.
- **Grid:** Refers to vessels containing multiple grid patterns on them, such as slides with groupings of microarrays. It has the format 0, 1, 2... etc.
- **Row:** Refers to the row number in the selected culture vessel.
- **Column:** Refers to the column number in the selected culture vessel.
- **Field:** Refers to the field of view that was captured and has the form f01, f02, f03... etc. Fields are numbered based on the order in which they were captured.
- **Channel:** Refers to the channel in which the image was captured and has the form d0, d1, d2... etc. A single-channel assay will be labeled with d0 in the file name.

For example, the image with the following name was captured at time point 2 through channel 1 in a time lapse z-stack scan. It shows the field 1 in the z-plane 1 in grid 0, row B, and column 3.

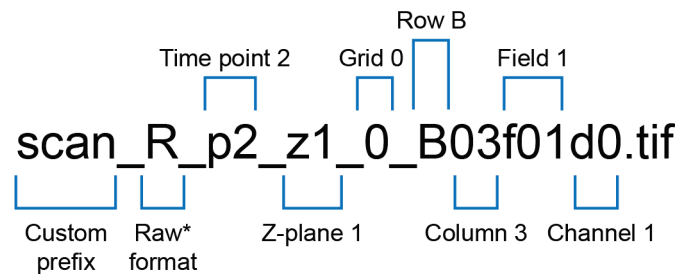

\* R = Raw  
D = Display  
M = Merged

# Review tab

## Overview

Review tab allows you to review saved images and associated metadata, and to re-save or delete saved files.

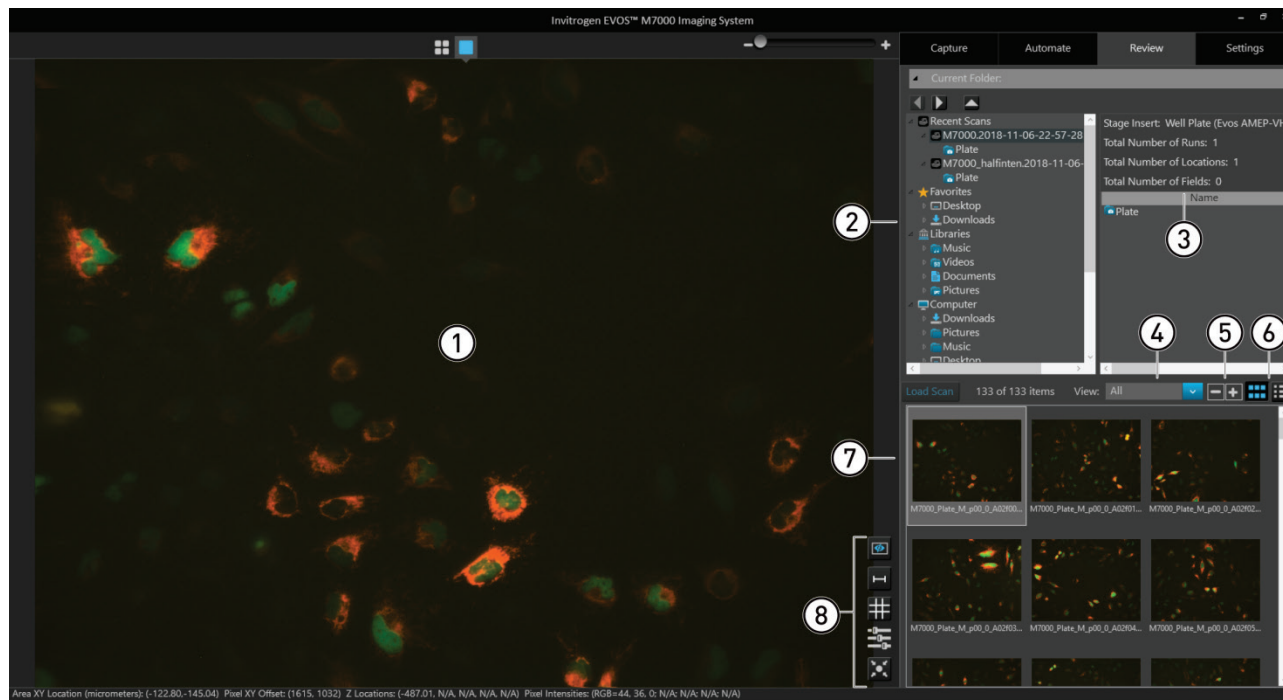

- ① Viewing area (page 192)
- ② Folders (page 194)
- ③ Images/Metadata (page 194)
- ④ View (page 195)
- ⑤ Preview size (page 195)
- ⑥ Thumbnail view/List view (page 195)
- ⑦ Image preview/Image list (page 195)
- ⑧ Display options (page 195)

### ① Viewing area: Displays the selected image.

- To display an image in the Viewing area, select the image in the Image preview/Image list area, then click **Load Scan**.
- Alternatively, double-click the image you have selected in the Image preview/Image list area to display it in the Viewing area.

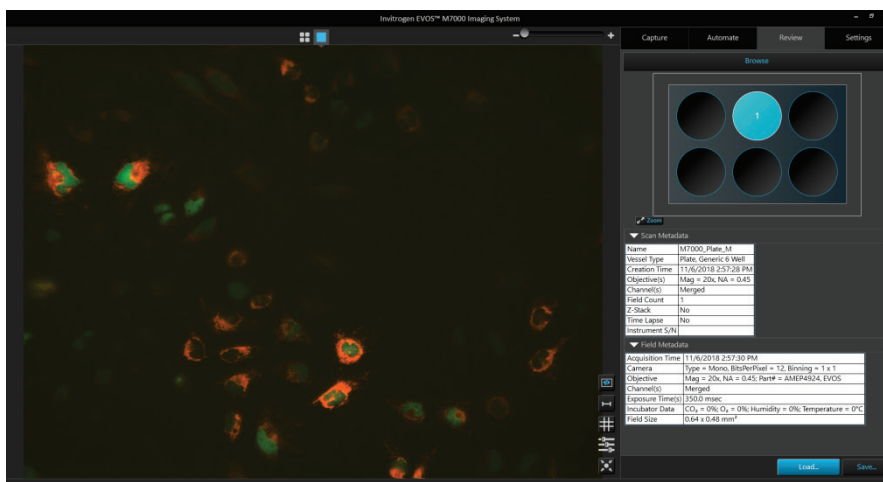

- When you open a folder containing images, the **Scan Metadata** panel shows metadata about the scan and the **Field Metadata** panel shows the metadata concerning the imaged field displayed.

▼ Scan Metadata	
Name	M7000_Plate_M
Vessel Type	Plate, Generic 6 Well
Creation Time	11/6/2018 2:57:28 PM
Objective(s)	Mag = 20x, NA = 0.45
Channel(s)	Merged
Field Count	1
Z-Stack	No
Time Lapse	No
Instrument S/N	

▼ Field Metadata	
Acquisition Time	11/6/2018 2:57:30 PM
Camera	Type = Mono, BitsPerPixel = 12, Binning = 1 x 1
Objective	Mag = 20x, NA = 0.45; Part# = AMEP4924, EVOS
Channel(s)	Merged
Exposure Time(s)	350.0 msec
Incubator Data	CO <sub>2</sub> = 0%; O <sub>2</sub> = 0%; Humidity = 0%; Temperature = 0°C
Field Size	0.64 x 0.48 mm <sup>2</sup>

- The Vessel map shows the location of the Field that is displayed in the Viewing area.

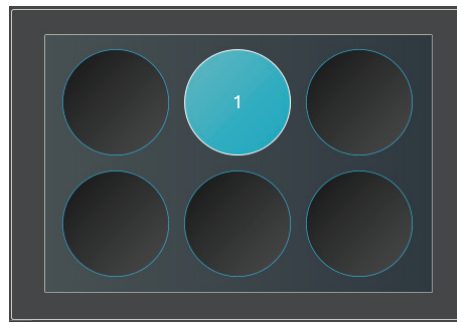

**Note:** You can also position your pointer over a scan or plate in the Browse panel or over an image in the Image preview/Image list panel without clicking to display the metadata associated with that scan, plate, or image.

Prefix: M7000 Vessel Holder: Plate Image Type: Merged, Raw, Tiled Merged Total Number of Time Points: 1 Total Number of Wells: 1 Total Number of Fields: 44	Recent Scans	Stage Insert: Well Plate (Evos AMEP-VH)	
	<ul style="list-style-type: none"> <li>M7000_halfinten.2018-11-06-23-00- Plate</li> <li>M7000.2018-11-06-22-57-28 Plate</li> </ul>	Total Number of Runs: 1	
		Total Number of Locations: 1	
		Total Number of Fields: 0	
		<table border="1"> <thead> <tr> <th>Name</th> </tr> </thead> <tbody> <tr> <td>Plate</td> </tr> </tbody> </table>	Name
Name			
Plate			

- ② **Folders:** Allows you to navigate to the folder containing your saved images, and to select saved images display in the Image preview area.

The folder containing saved images can be in an external storage device (USB flash drive), on the computer workstation running the EVOS™ M7000 Imaging System, or on the local network (if connected).

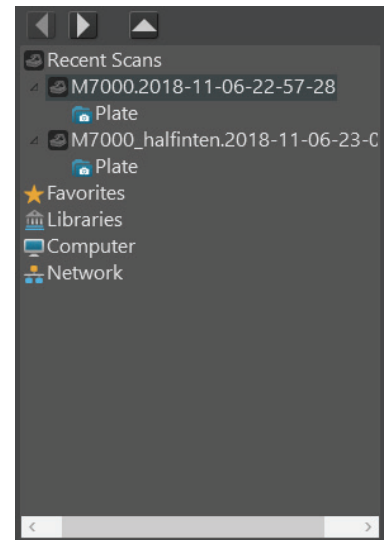

- ③ **Images/Metadata:** Lists the images or scans saved within the selected folder (if an image folder is selected in the Folders panel) or the scan metadata for the selected scan (if a scan is selected in the Folders panel).

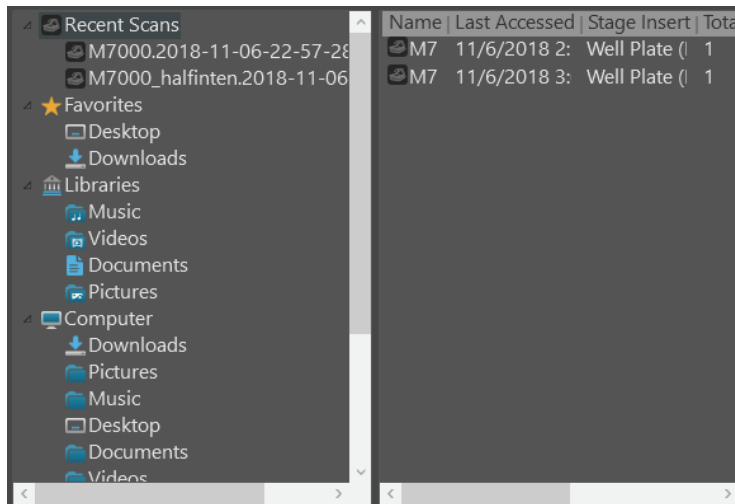

Image/Scans list (Recent Scans folder is selected in Folders panel)

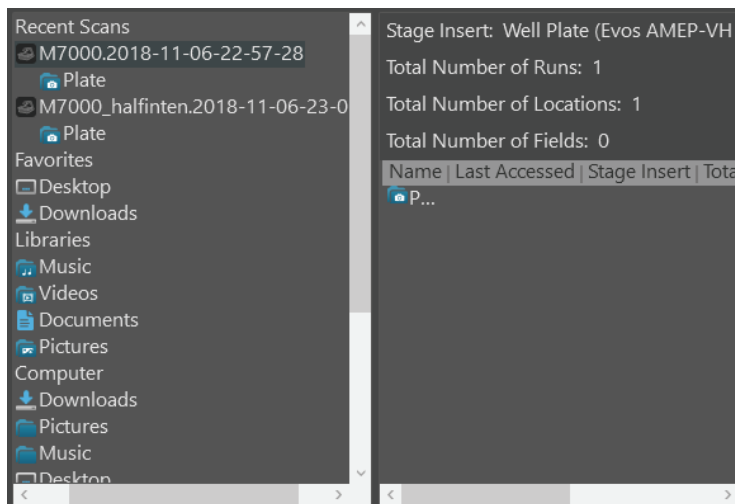

Scan metadata (A scans file is selected in Folders panel)

- ④ **View:** Allows you to filter the image files displayed in the preview area.



Available options are **All**, **Raw**, **Displayed**, **Tiled**, **Merged**, and **Other**.

- ⑤ **Preview size buttons:** Allow you to increase or decrease the display size of the image thumbnails in the Preview area.



- ⑥ **Thumbnail view/List view toggle:** Allows you to display the saved images in the Preview area as thumbnails or as a list.



- ⑦ **Image preview/Image list:** Allows you to select the image to display in the Viewing area. The selected image is indicated with a blue box around it.

Double-click the selected image to display it in the Viewing area.

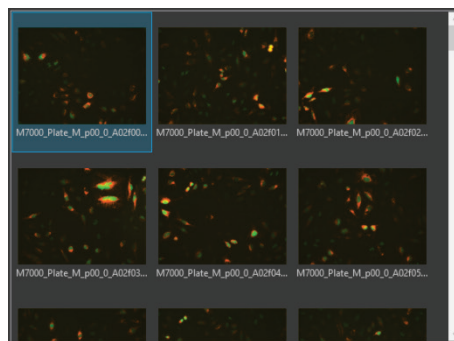

Thumbnail view

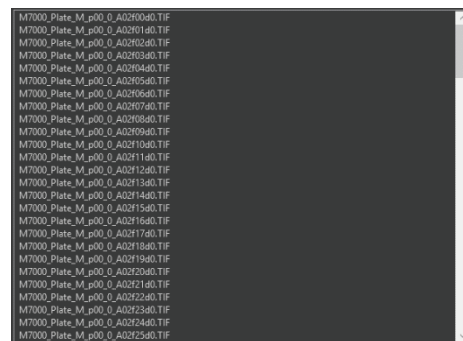

List view

- ⑧ **Display options:** Allows you to set image display options in the Viewing area.

The following display options are available in the Review tab:

1. **Toggle field borders** (page 129)
2. **Toggle scale bar** (page 132)
3. **Toggle sample grid** (page 132)
4. **Image display settings** (page 132)
5. **Center on selected field** (page 130)



**Note:** Display options in the Review tab are visible only when an image is displayed in the Viewing area.

# Settings

## Settings tab overview

Settings tab is used for selecting basic and advanced system options and for performing calibration and maintenance procedures.

To access the Settings tab, click the **Settings** tab anytime from the Capture, Automate, and Review tabs.

To close the Settings tab and return to the previous tab, click **Done**.

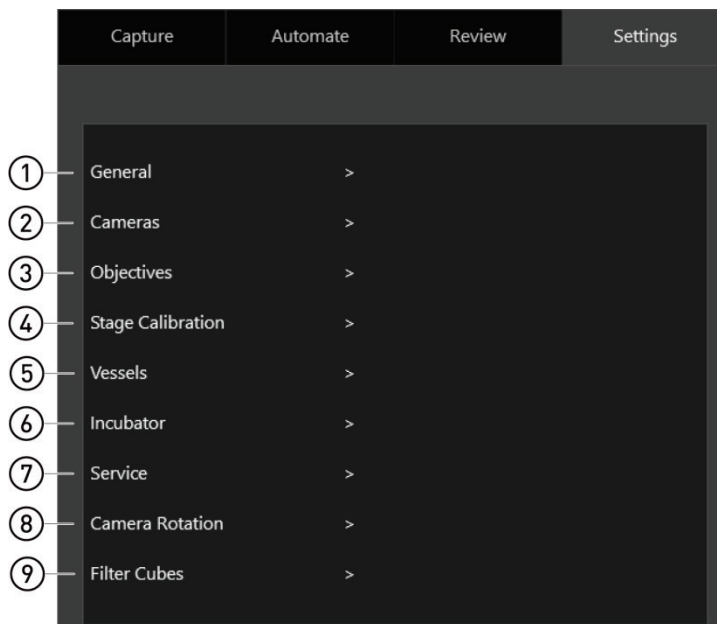

## General settings controls

- ① **General:** Allows you to set the Saturated Pixel, Jog Control, Scale Bar, Grid Settings, and AutoFocus options (page 197).
- ② **Cameras:** Allows you to perform Hot Pixel Correction for the monochrome camera and to adjust White Balance for the color camera (page 199)
- ③ **Objectives:** Allows you to set up and calibrate objectives and assign objective profiles (page 201).
- ④ **Stage Calibration:** Opens the Stage Calibration tool, which allows you to calibrate the automatic X-Y axis stage for accurate instrument function (page 204).
- ⑤ **Vessels:** Allows you to select sample vessels, calibrate the instrument for the selected vessel, to import and export vessel information, and to import stage insert information (page 205)
- ⑥ **Incubator:** Allows you to configure the gas inputs, calibrate the oxygen sensor, and set the temperature offsets for the EVOS™ Onstage Incubator (page 208). The Incubator panel is only visible when an EVOS™ Onstage Incubator is connected to your EVOS™ M7000 Imaging System.
- ⑦ **Service:** Provides version information about instrument software and firmware (page 210).
- ⑧ **Camera Rotation:** Allows you to calibrate the camera rotation for accurate instrument function (page 212).
- ⑨ **Filter Cubes:** Allows you to add or remove EVOS™ LED light cubes and to assign pseudocolors for installed light cubes (page 213).

## General

General panel in the Settings tab allows you to set the Saturated Pixel, Jog Control, Scale Bar, and Grid Settings options. To expand or collapse the controls for a setting, click the corresponding arrow.

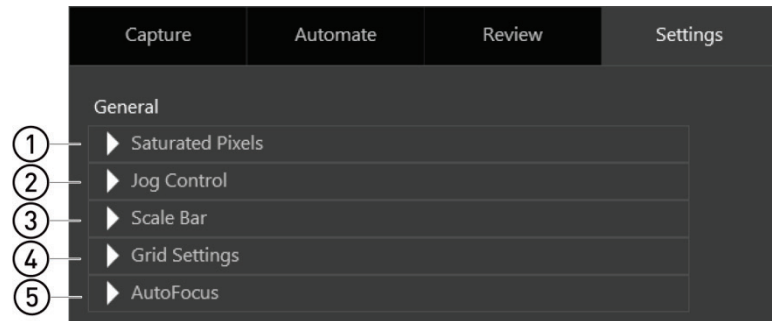

- ① Saturated Pixels (page 197)
- ② Jog Control (page 197)
- ③ Scale Bar (page 197)
- ④ Grid Settings (page 198)
- ⑤ AutoFocus (page 198)

## General settings controls

- ① **Saturated Pixels:** Displays saturated pixels on an image with the user-defined color, which provides a visual aid for optimal illumination when adjusting the brightness settings in **Live mode**.

Available colors for saturated pixels are **Blue, Red, and Green**.

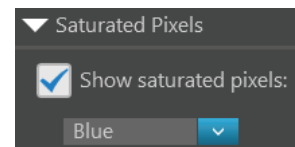

- ② **Jog Control:** Allows you to invert the direction of the stage movement as input by the Jog Control button (page 143).

Available options are **Invert Horizontally** and **Invert Vertically**.

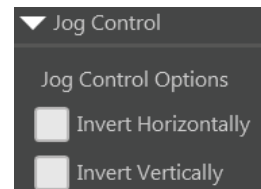

- ③ **Scale Bar:** Allows you to set the display options for the scale bar.

- Select **Move Freely** to be able to drag the scale bar anywhere in the Viewing area or select **Dock Location** to dock it in the **bottom** or **top left** or **right** corners of the Viewing area.

When set to move freely, click **Reset to Default** to place the scale bar in the bottom left corner.

- Other scale bar display options include:
  - **Display End Bars:** Adds end bars to the scale bar.
  - **Display Text:** Displays the size of the scale bar. You can select to display the scale information using **small, medium, or large** sized fonts.
  - **Select Scale Bar Width:** Allows you select the width of the scale bar (**narrow, medium, wide**).
  - **Select Color:** Allows you to select the color of the scale bar (**black or white**).

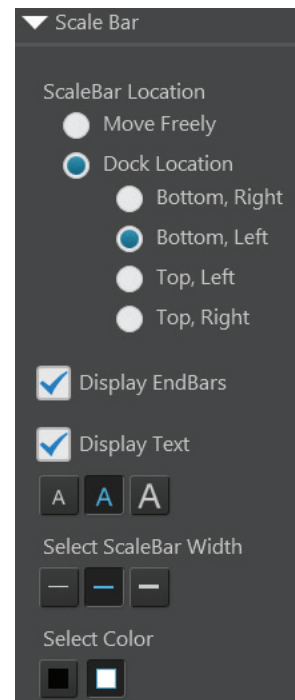



④ **Grid Settings:** Allows you to set the display options for the sample grid that is displayed in the Viewing area.

- **Select Color:** Sets the color of the grid. Available options are **white**, **light grey**, **dark grey**, and **black**.
- **Grid Alignment:** Determines how the grid is aligned to the Viewing area. Available options are:
  - **Cross-hair at center**
  - **Grid Square at the center**

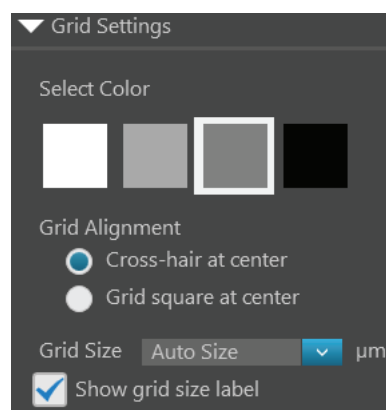

- **Grid Size:** Allow you select the grid size (i.e., the unit size of the squares that form the grid), which is expressed in µm.

You have the following options for the grid size (in pixels):

**Auto**, **10 × 10**, **50 × 50**, **100 × 100**, **200 × 200**, and **500 × 500**.

When the **Auto Size** option is selected, the software automatically adjusts the grid spacing if the chosen value results in more than 50 grid lines per image.

- **Show grid size label:** Displays the unit size of the squares that form the grid.

⑤ **AutoFocus:** Allows you set AutoFocus options.

- **Quick AutoFocus:** If checked, the software runs coarse focus until it identifies the first high-contrast object that can be found, then runs fine autofocus.

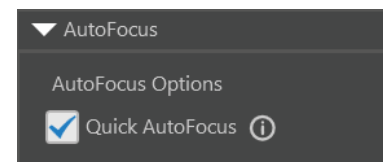

If unchecked, the software runs through the entire autofocus range, then runs fine autofocus around the highest-contrast object that can be detected.

---

**Note:** For samples that contain air bubbles or debris, we recommend that the Quick AutoFocus option is disabled.

---

## Cameras

Cameras panel in the Settings tab allows you to perform Hot Pixel Correction for the monochrome camera and to adjust White Balance for the color camera.

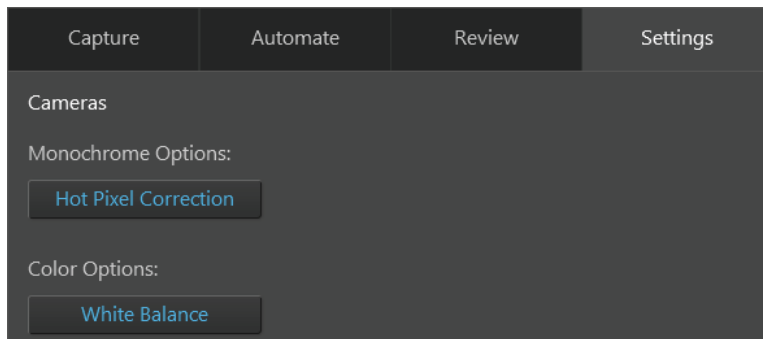

- ① **Hot Pixel Correction** (page 199)
- ② **White Balance** (page 200)

## Cameras controls

- ① **Hot Pixel Correction:** Opens the Hot Pixel Correction dialog, which allows you to search for hot pixels in the monochrome camera and reset the brightness value of all hot pixels to a base pixel intensity level.

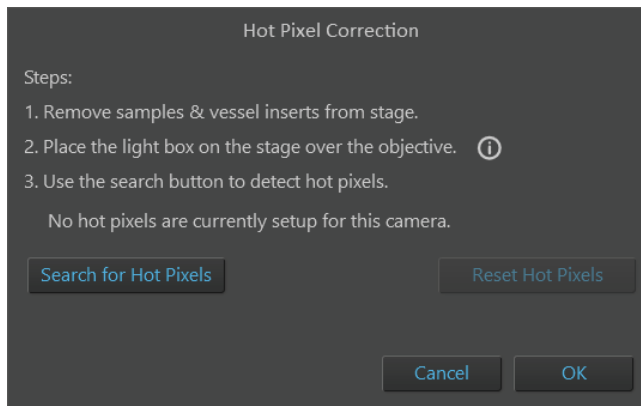

Hot pixels are caused by electrical charges that leak into the sensor wells and they appear brighter than the other pixels in the camera. Hot Pixel Correction algorithm of the EVOS™ M7000 software stores the location and value of the hot pixels in its memory for subsequent automatic hot pixel correction.

- **Search for Hot Pixels:** Prompts the software to search for hot pixels in the image.  
Click **OK** to save the location of hot pixels for subsequent correction.
- **Reset Hot Pixels:** Resets the hot pixel locations to the factory default.

- ② **White Balance:** Opens the White Balance dialog, which allows you to adjust the white balance on the color camera manually or automatically.

White Balance

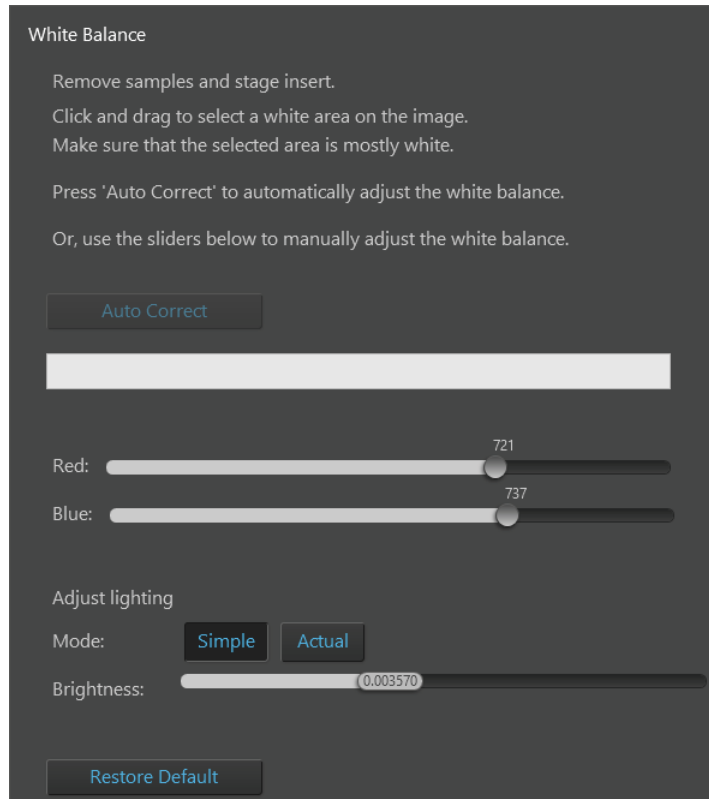

- To automatically adjust the white balance, find a white area on the image, click and drag to select that area on the field of view, then click **Auto Correct**.
- To manually adjust the white balance, find a white area on the image, then use the **Red** and **Blue sliders**.

## Objectives

Objectives panel in the Settings tab allows you to assign and unassign objectives on the objective turret, and to calibrate objective magnification.

Objectives

To assign an objective profile, drag the profile from the list on the left to the turret position on the right.

Profiles

Add Copy Edit

Manufacturer	Part Number	Working Distance
1.25x		
Olympus	AMEP4736	5.11
2x		
EVOS	AMEP4631	5.1
EVOS	AMEP4931	5.62
Olympus	AMEP4751	6.22
4x		
EVOS	AMEP4922	10.58
EVOS	AMEP4932	10.58
EVOS	AMEP4980	10.58
EVOS	AMEP4632	16.9
EVOS	AMEP4680	16.9
EVOS	AMEP4622	19.7

Active Turret pos.

- 10 x Evos 8.4 ( AMEP4623 )
- 20 x EVOS 7.1 ( AMEP4624 )
- 20 x EVOS 6.23 ( AMEP4924 )
- empty
- empty

Calibrate

Details:

Manufacturer: EVOS

Part number: AMEP4924

Display Name:

Magnification class	20x
Numerical Aperture	0.45
Working Distance	6.23 mm
Working Medium	Air
Color Correction	Fluorite
Objective Diameter	20 mm
Phase Contrast	no
Phase Position	
Flat-Field Correction	Plan

Undo Cancel Done

① Profiles (page 202)

② Active (page 202)

③ Calibrate (page 203)

④ Display name (page 203)

⑤ Details (page 203)

---

**Note:** For specific instructions on how to change and calibrate objectives, see “Change the objectives” (page 112) and “Calibrate the objectives” (page 114).

---

## Objectives controls

- ① **Profiles:** Displays the objective profiles that are available to be assigned to the active objectives in the turret.

The profiles are grouped by magnification and include manufacturer, part numbers, and working distance information.

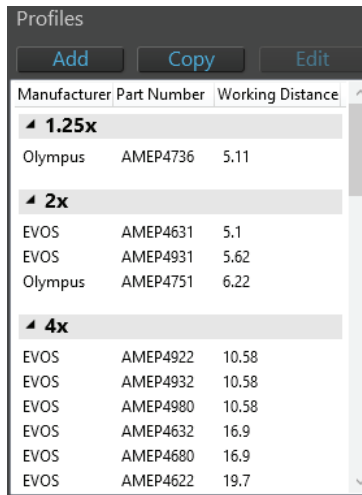

Manufacturer	Part Number	Working Distance
<b>1.25x</b>		
Olympus	AMEP4736	5.11
<b>2x</b>		
EVOS	AMEP4631	5.1
EVOS	AMEP4931	5.62
Olympus	AMEP4751	6.22
<b>4x</b>		
EVOS	AMEP4922	10.58
EVOS	AMEP4932	10.58
EVOS	AMEP4980	10.58
EVOS	AMEP4632	16.9
EVOS	AMEP4680	16.9
EVOS	AMEP4622	19.7

- To add a new profile, click **Add**.
  - To copy a profile, click **Copy**.
  - To edit a profile, click **Edit**.
- ② **Active:** Lists the objectives installed in the objective turret and allows you to assign and unassign objectives from the Profiles list.

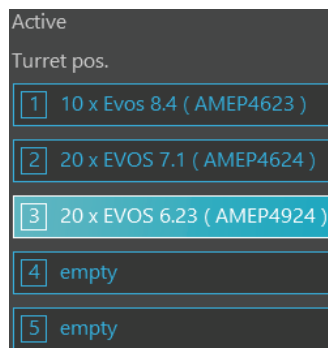

Turret pos.
1 10 x Evos 8.4 ( AMEP4623 )
2 20 x EVOS 7.1 ( AMEP4624 )
3 20 x EVOS 6.23 ( AMEP4924 )
4 empty
5 empty

- The active objective list provides information about magnification, manufacturer, working distance, and part number for the objectives assigned to each turret position.
- If there is no objective assigned to a turret position, the list displays "empty".
- Currently selected (active) objective in the turret is highlighted in blue. To select another objective, click the desired objective position.
- To assign a profile to a newly installed objective, click and drag the profile from the Profiles list to the appropriate Turret position in the Active list (see "Change the objectives", page 112).

- ③ **Calibrate:** Opens the Objective Calibration tool, which allows you to calibrate the field of view, parfocality, and parcentration parameters of the selected objective (see “Calibrate the objectives”, page 114).

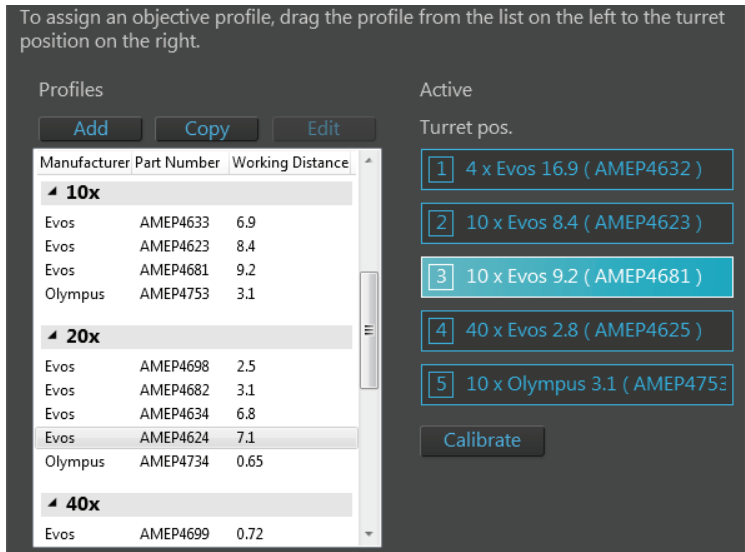

- ④ **Display name:** Allows you assign a label for the selected objective, which is displayed on the Objective button in the Capture tab.

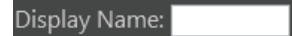

In the following example, “NoPH” is entered as the Display Name. The Objective button in the Capture tab displays the label “NoPH” below the objective magnification.

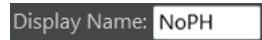

- ⑤ **Details:** Displays the detailed information about the active objective in the turret.

Details:

Manufacturer: EVOS  
 Part number: AMEP4924  
 Display Name:  ⓘ

Magnification class	20x
Numerical Aperture	0.45
Working Distance	6.23 mm
Working Medium	Air
Color Correction	Fluorite
Objective Diameter	20 mm
Phase Contrast	no
Phase Position	
Flat-Field Correction	Plan

## Stage calibration

Stage Calibration panel allows you to calibrate the position of the automatic X-Y stage for accurate instrument function.

Note that the stage calibration procedure requires the EVOS™ Calibration Slide supplied with the instrument (also available separately; Cat. No. AMEP4720).

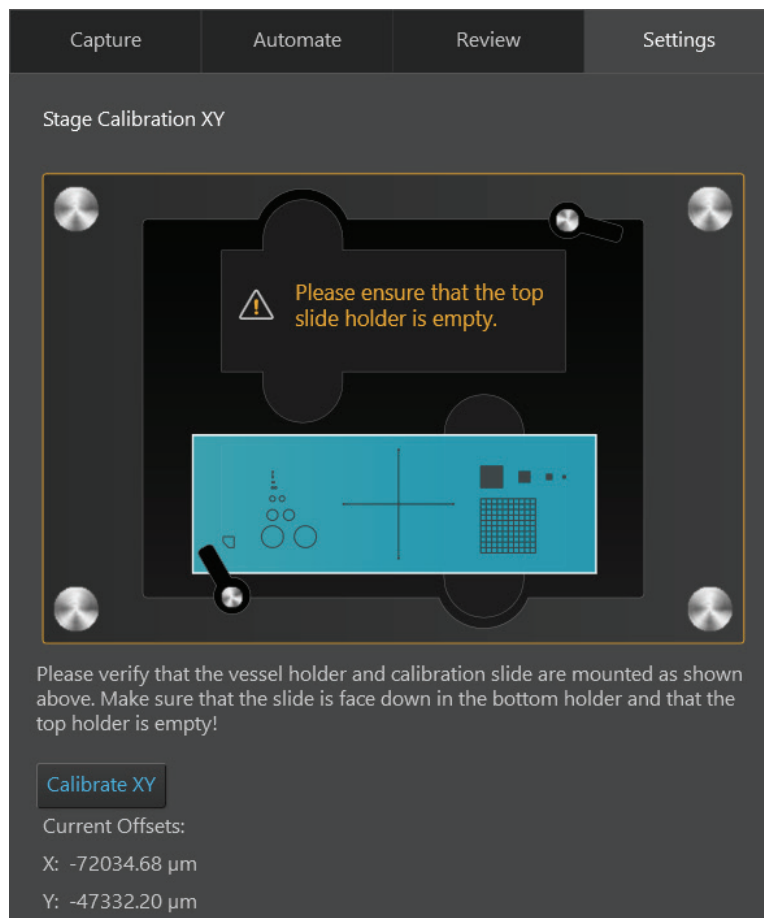

---

**Note:** For specific instructions on how to calibrate the stage, see “Calibrate the stage” (page 105).

---

## Vessels

Vessels panel allows you to select sample vessels, calibrate the instrument for the selected vessel, to import and export vessel information, and to import stage insert information.

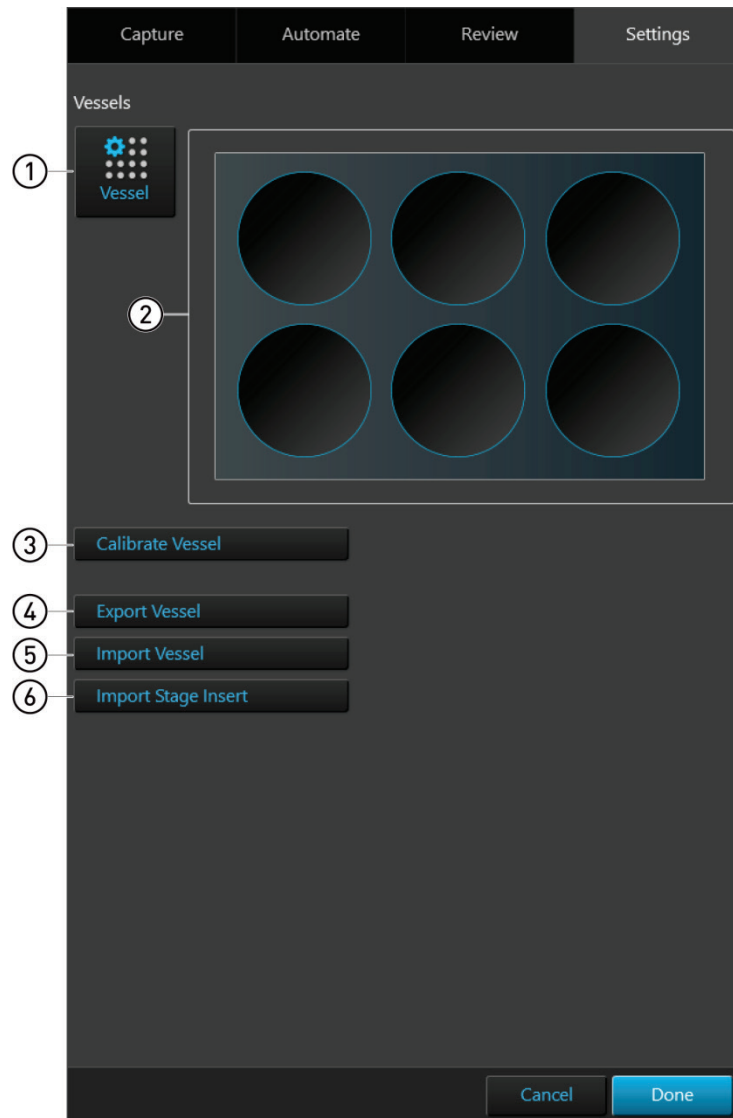

① **Vessel** (page 206)

② **Vessel map** (page 206)

③ **Calibrate Vessel** (page 207)

④ **Export Vessel** (page 207)

⑤ **Import Vessel** (page 207)

⑥ **Import Stage Insert** (page 207)

---

**Note:** For specific instructions on how to calibrate the instrument for the selected vessel, see "Calibrate vessel" (page 107).

---



## Vessels controls

- ① **Vessel:** Opens the Vessel Selection dialog, which allows you to select the vessel you want to calibrate or export.

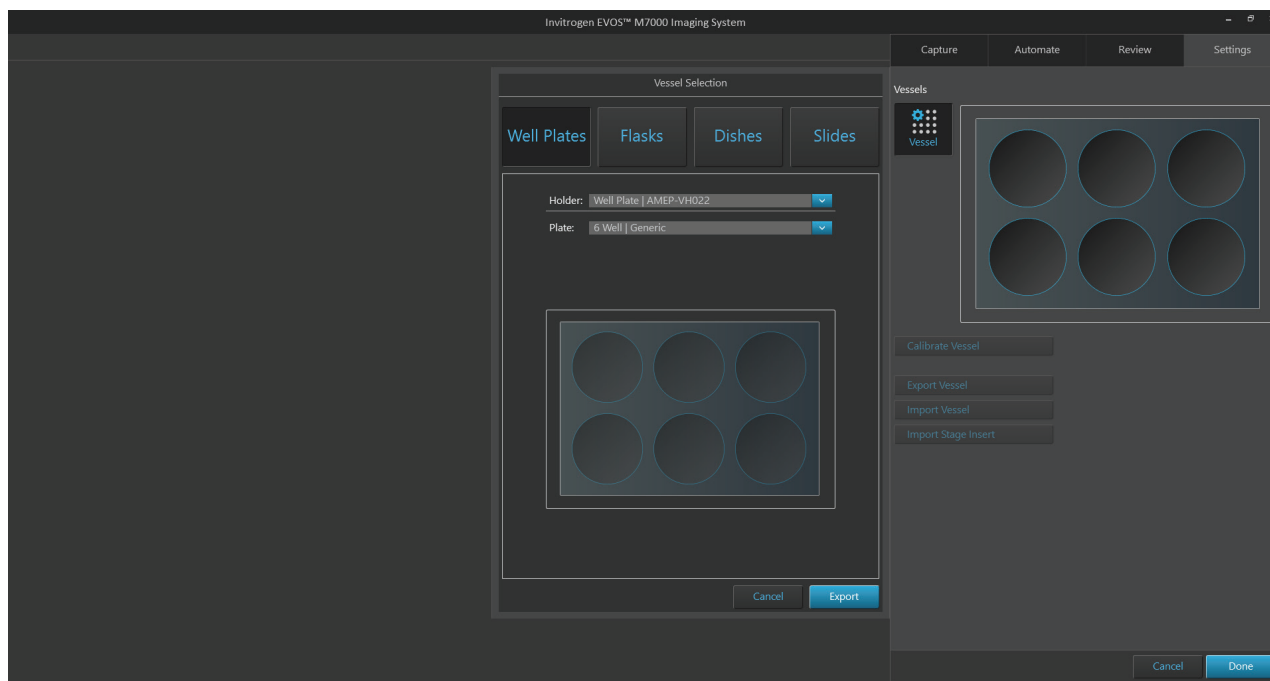
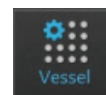

- Select the **Vessel category** that corresponds to your sample vessel to display the holder and vessel type selections available for that category. Available vessel categories are **Well Plates**, **Flasks**, **Dishes**, and **Slides**.



- Select the appropriate **Holder** and **Vessel type** from the dropdown menus available for your vessel category.

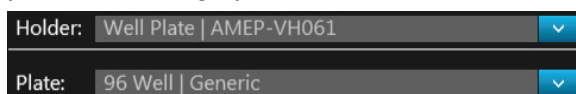

- Click **Export** to open the Save As dialog, which allows you to save the vessel information as a \*.vessel file at the desired destination directory.

- ② **Vessel map:** Represents the vessel container (vessel + vessel holder) in use, as determined by the selection made in the Vessel selection dropdown.

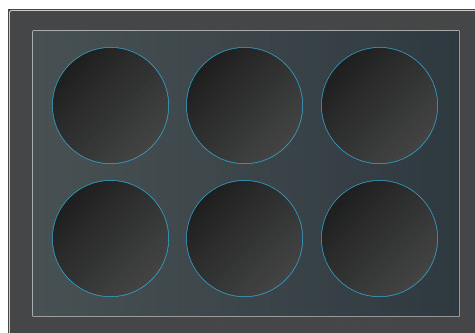

- ③ **Calibrate Vessel:** Opens the Vessel Calibration dialog, which allows you to update the selected vessel with new calibration values or to save them as a new vessel. The calibration values are vessel-specific coordinates that allow the EVOS™ M7000 Imaging System to correctly scan the sample vessel.

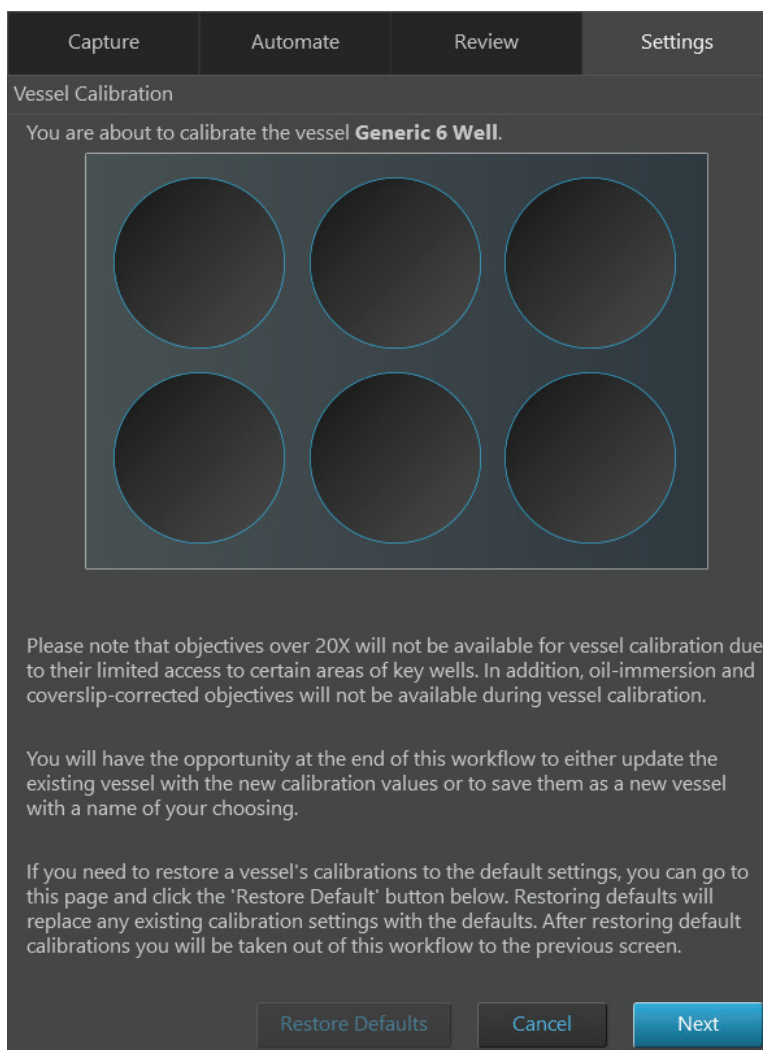

**Note:** For specific instructions on how to calibrate the instrument for the selected vessel, see “Calibrate vessel” (page 107).

- ④ **Export Vessel:** Allows you to export the vessel information and associated calibration values as a \*.vessel file in the desired destination directory.



- ⑤ **Import Vessel:** Allows you to import \*.vessel files that contain vessel information and associated calibration values.



- ⑥ **Import Stage Insert:** Allows you to import \*.stageinsert files that contain stage insert information and associated calibration values.



## Incubator

Incubator panel allows you to configure the gas inputs, calibrate the oxygen sensor, and set the temperature offsets for the EVOS™ Onstage Incubator (page 208).

**Note:** The Incubator panel is only visible when an EVOS™ Onstage Incubator is connected to your EVOS™ M7000 Imaging System.

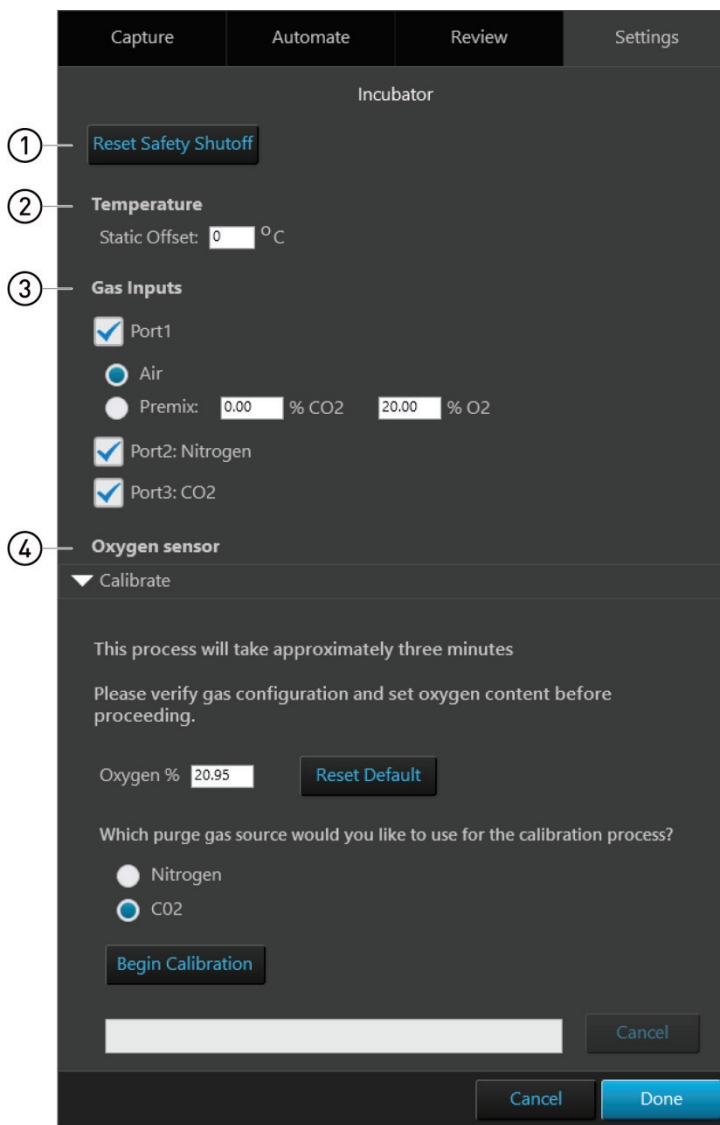

- ① **Reset Safety Shutoff** (page 209)
- ② **Temperature** (page 209)
- ③ **Gas Inputs** (page 209)
- ④ **Oxygen Sensor** (page 209)

**Note:** For specific instructions on how to set up the EVOS™ Onstage Incubator and use it with the EVOS™ M7000 Imaging System, see “Appendix D: EVOS™ Onstage Incubator” (page 224).

## Incubator controls

- ① **Reset Safety Shutoff:** Resets the EVOS™ Onstage Incubator after an automatic safety shutoff event.
- ② **Temperature:** Used to set the Static Offset, which allows you to adjust temperature readings based on the ambient room temperature. This should remain at 0 by default.
- ③ **Gas Inputs:** Allows you to configure **Gas Inputs** that reflect your set-up for the EVOS™ Onstage Incubator.

Reset Safety Shutoff

Temperature  
Static Offset: 0 °C

Gas Inputs

- Port1
  - Air
  - Premix: 0.00 % CO2 20.00 % O2
- Port2: Nitrogen
- Port3: CO2

- For **Port 1**, select **Air** or **Premix**.  
If you select **Premix**, manually enter the percentage of the **CO<sub>2</sub>** and **O<sub>2</sub>** to reflect the specifics of your set-up.
- **Port 2** is reserved for Nitrogen only.
- **Port 3** is reserved for CO<sub>2</sub> only.

For instructions on how to configure the gas inputs to the EVOS™ Onstage Incubator, see page 234.

- ④ **Oxygen Sensor:** Allows you to calibrate the oxygen sensor when using separate tanks for gases.

Oxygen sensor

▼ Calibrate

This process will take approximately three minutes

Please verify gas configuration and set oxygen content before proceeding.

Oxygen % 20.95 Reset Default

Which purge gas source would you like to use for the calibration process?

- Nitrogen
- C02

Begin Calibration Cancel

For instructions on how to calibrate the EVOS™ Onstage Incubator oxygen sensor, see page 235.

## Service

Service panel display the EVOS™ M7000 software and firmware versions, and allows you to calibrate the objective turret, copy log files to a USB drive, move the X-Y stage to the shipping position, and change the cache location.

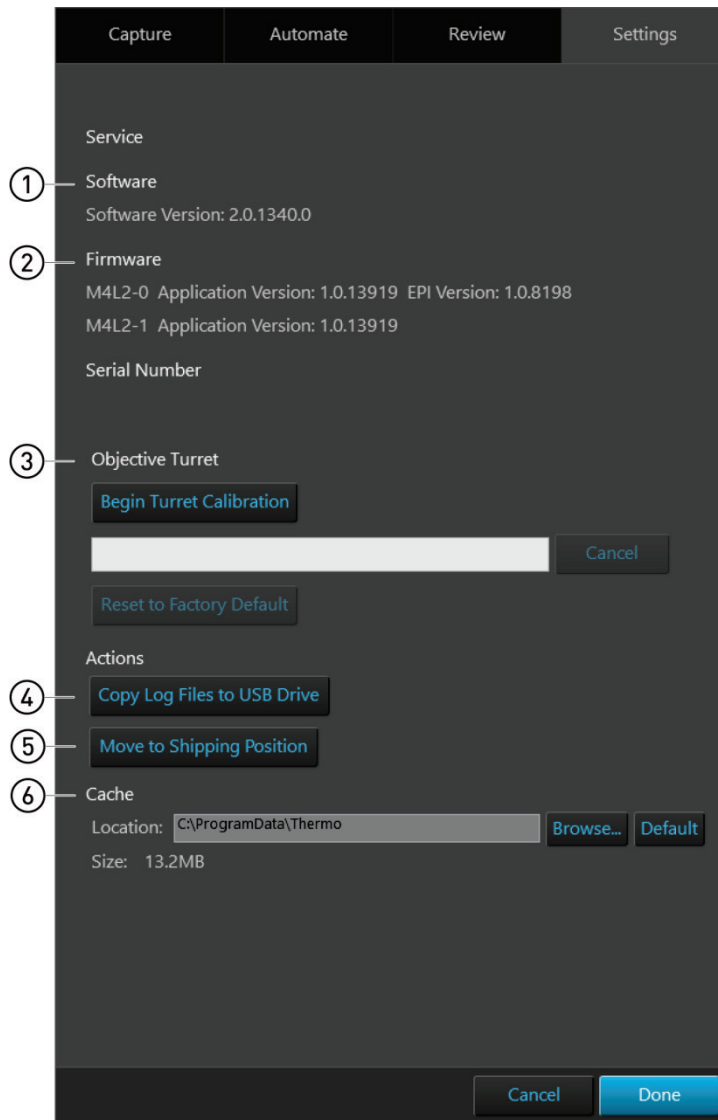

- ① **Software version** (page 210)
- ② **Firmware version** (page 210)
- ③ **Objective Turret** (page 211)
- ④ **Copy Log Files to USB** (page 211)
- ⑤ **Move to Shipping Position** (page 211)
- ⑥ **Cache** (page 211)

## Service controls

- ① **Software version:** Displays the installed EVOS™ M7000 software information.

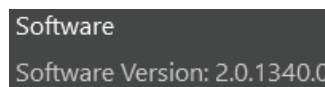

- ② **Firmware version:** Displays the installed EVOS™ M7000 firmware information.

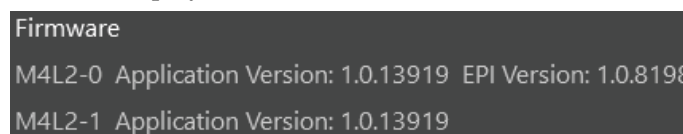

- ③ **Objective Turret:** Allows you to calibrate the objective turret.

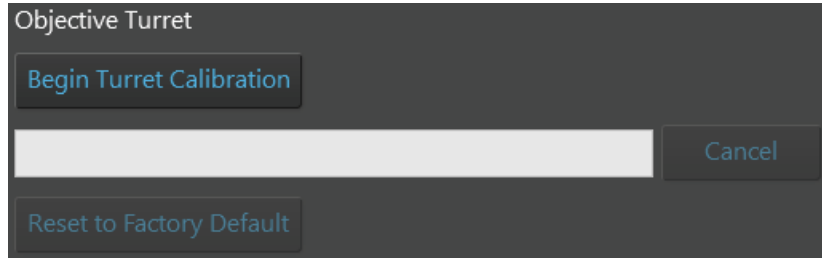

- **Begin Turret Calibration:** Initiates the turret calibration process. The progress of the calibration is updated on the calibration progress bar.
- **Reset to Factory Default:** Resets the objective calibration values to factory default values.

- ④ **Copy Log Files to USB Drive:** Saves the EVOS™ M7000 log files from the instrument cache to an external USB drive.

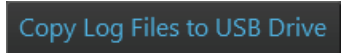

- ⑤ **Move to Shipping Position:** Moves the X-Y stage to the shipping position and provides instructions for the installation of shipping restraints.

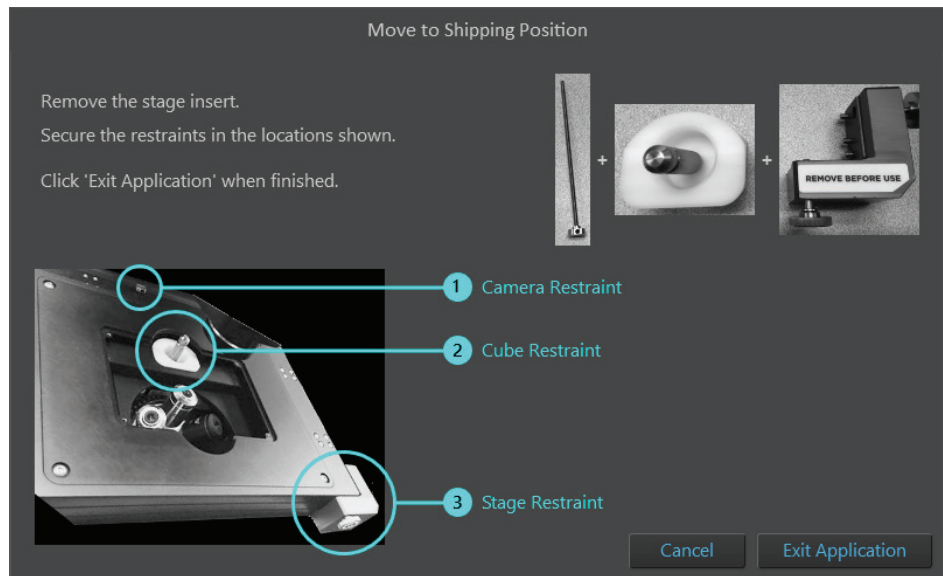
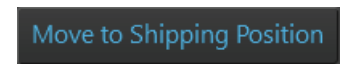

For instructions on how to install the shipping restraints to prevent damage to the EVOS™ M7000 Imaging System, see “Install shipping restraints”, page 118.

- ⑥ **Cache:** Displays the location and size of the instrument memory cache and allows you to change the location where the cache is stored.



## Camera rotation

Camera Rotation panel allows you to calibrate the camera rotation to maintain high image tiling quality.

Note that the camera rotation calibration requires the EVOS™ Calibration Slide supplied with the instrument (also available separately; Cat. No. AMEP4720).

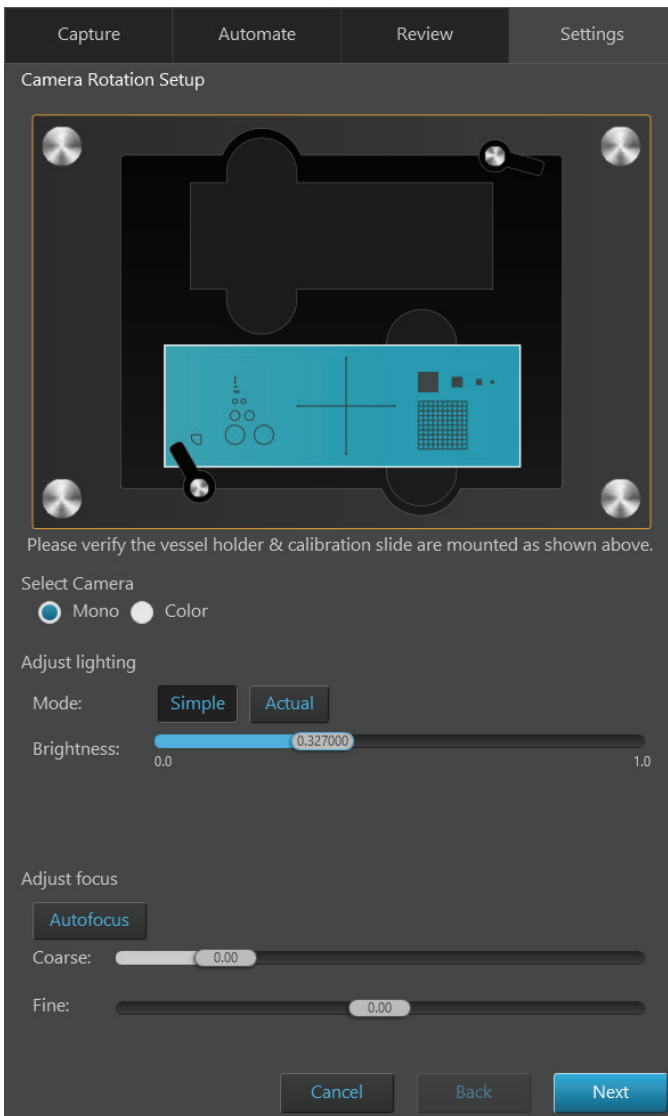

- To calibrate the camera rotation, insert the EVOS™ Calibration Slide into the instrument, adjust the **Brightness**, then **Focus** on the crosshairs of the calibration slide. When you have focused on the crosshairs, click **Next** to begin the calibration of camera rotation.

## Filter Cubes

Filter Cubes panel allows you to add or remove EVOS™ LED light cubes from the instrument and to assign pseudocolors to installed light cubes.

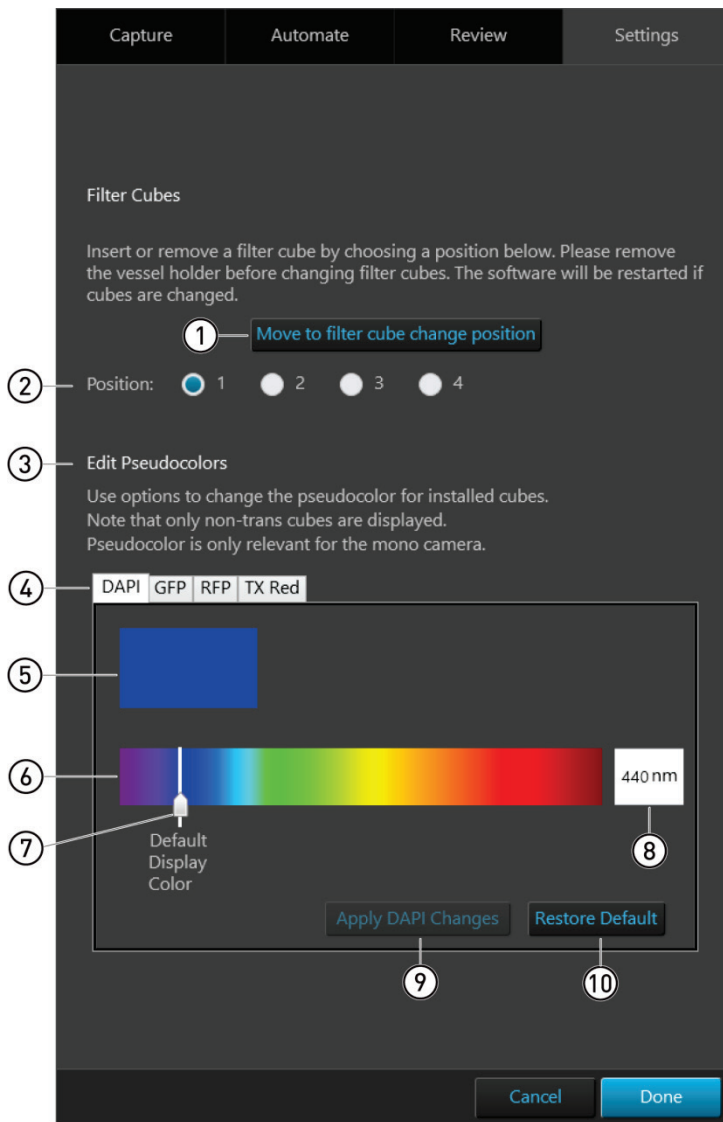

- ① Move to filter cube change position (page 214)
- ② Position (page 214)
- ③ Edit Pseudocolors (page 214)
- ④ Filter cube tabs (page 214)
- ⑤ Current pseudocolor (page 214)
- ⑥ Color spectrum (page 214)
- ⑦ Color slider (page 214)
- ⑧ Wavelength (page 214)
- ⑨ Apply changes (page 214)
- ⑩ Restore Default (page 214)



## Filter Cubes controls

- ① **Move to filter cube change position:** Moves the cube carriage into position so that the light cube at the selected position can be changed.

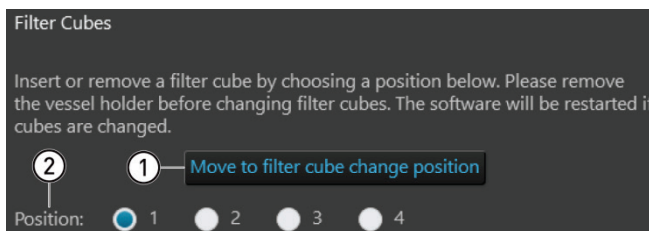

- ② **Position:** Selects the position of the light cube to be changed.

---

**Note:** To insert or remove a light cube, first select the **Position** of the light cube you want to change, then click **Move to filter cube change position**. For detailed instructions, see “Change EVOS™ light cubes” (page 107).

---

- ③ **Edit Pseudocolors:** Contains the controls to edit the pseudocolor for installed light cubes.

To select a new pseudocolor, move the **Color slider** to the desired position on the spectrum or enter the corresponding wavelength into the **Pseudocolor wavelength** text box.

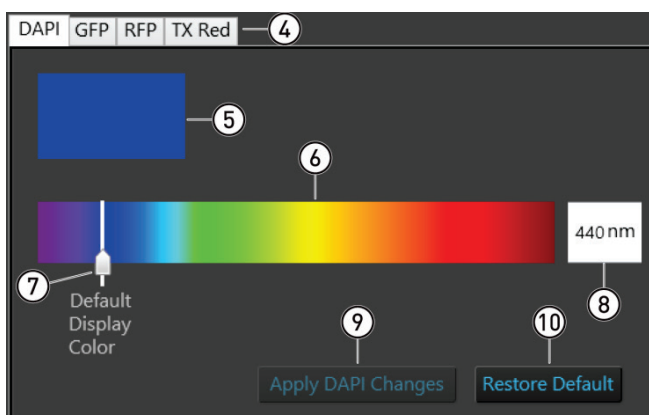

---

**Note:** You can assign pseudocolors only to non-transmitted light (fluorescence) light cubes. The assigned pseudocolor is only relevant for the monochrome camera.

---

- ④ **Filter cube tabs:** Each tab represents an installed light cube and contains the controls to change the pseudocolor assigned to that cube.
- ⑤ **Current pseudocolor:** Displays the pseudocolor assigned to the light cube.
- ⑥ **Color spectrum:** Represents the color spectrum available to choose as a pseudocolor for the light cube.
- ⑦ **Color slider:** Allows you to select the desired pseudocolor.
- ⑧ **Wavelength:** Allows you to enter the wavelength that corresponds to the pseudocolor you want to assign to the light cube.
- ⑨ **Apply changes:** Applies the selected pseudocolor to the light cube. To save the changes, click **Done** after applying the changes.
- ⑩ **Restore Default:** Restores the factory default pseudocolor to the light cube.

# EVOS™ Analysis Application

## Overview

The EVOS™ Analysis application is an image analysis and annotation tool that allows you to analyze and annotate saved images, perform auto or manual cell count, determine the confluence of the cell culture, and calculate the transfection efficiency.

When the EVOS™ Analysis application is launched (page 75), it opens to the Review screen, but does not display an image. To view an image, you must first select it from an image folder using the Review tab controls (page 216).

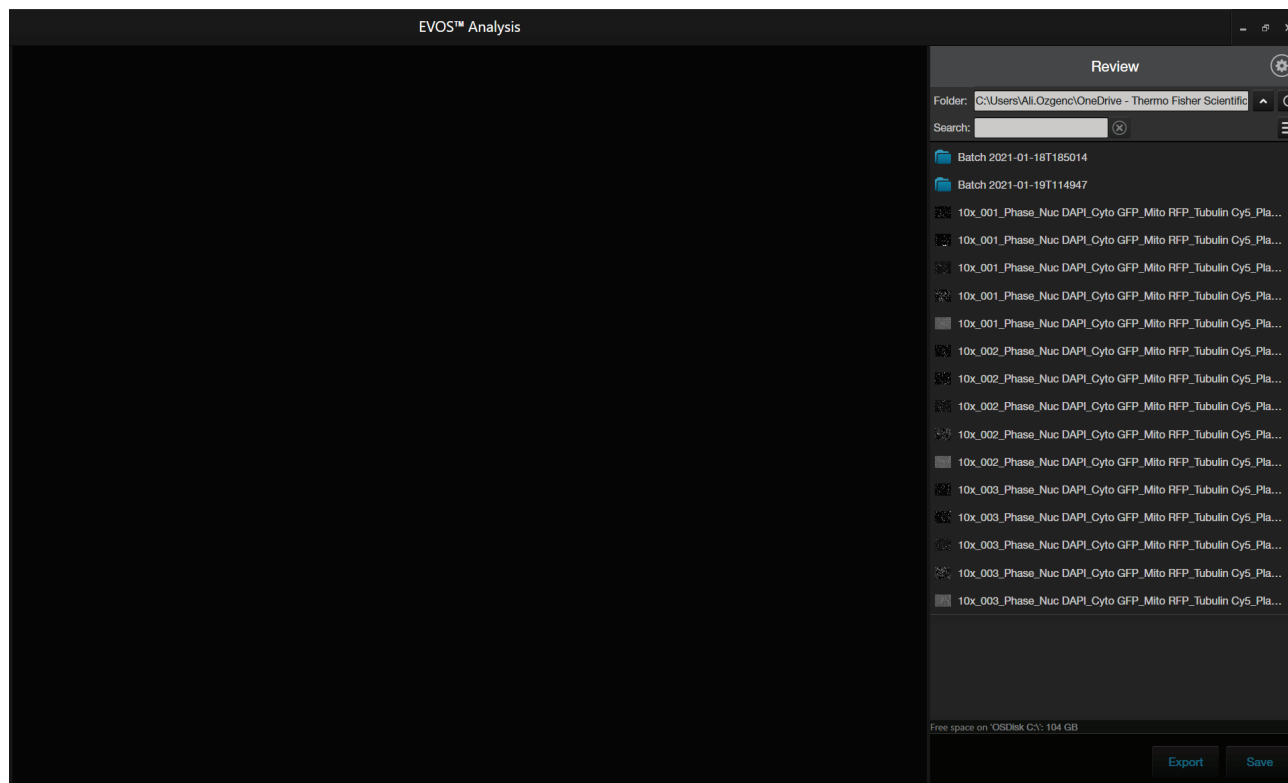

For detailed descriptions of specific EVOS™ Analysis application screens, refer to the following:

- Review tab (page 216)
- Display settings and analysis tools (page 217)
- Auto Count controls (page 219)
- Manual Count controls (page 220)
- Cell Culture tools – Confluence (page 221)
- Cell Culture tools – Transfection Efficiency (page 222)
- Settings tab (page 223)

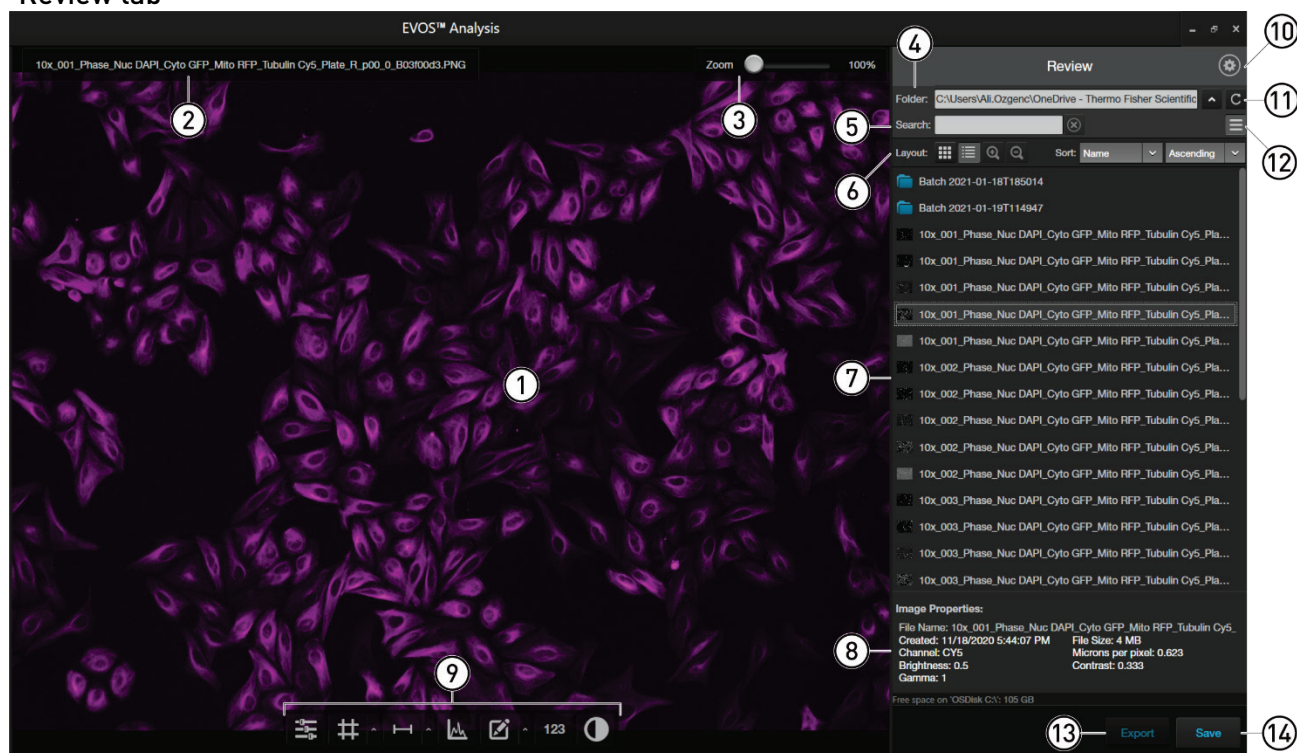

## Review tab



- Review tab controls**
- ① **Viewing area:** Displays the image selected from the Image preview/Image list.
  - ② **Image file name:** File name of the image displayed in the Viewing area.
  - ③ **Zoom slider:** Zooms in and out of the image. The zoom range is 100% to 1000%.
  - ④ **Folder:** Displays the location of the current folder or image.
  - ⑤ **Search:** Allows you to search by file name in the selected folder.
  - ⑥ **Layout:** Allows you to toggle between grid or list view, increase or decrease the display size of the folders or image files, and sort by name, file type, or date created in ascending or descending order.
  - ⑦ **Image preview/Image list:** Displays the preview or list of the files and subfolders in the current folder.
  - ⑧ **Image properties:** Displays the metadata for the selected image file.
  - ⑨ **Display and analysis tools:** Allow you to change image display settings in the Viewing area, annotate and analyze the captured images, and perform cell count and cell culture analysis (confluence and transfection efficiency). See page 217 for more information.
  - ⑩ **Settings:** Opens the Settings tab, which allows you to select image format options for saving TIFF files, view EVOS™ Analysis software version, and to copy error logs to a storage device.
  - ⑪ **Refresh:** Refreshes the list or grid of images in the current folder.
  - ⑫ **Display settings:** Displays or hides the Layout controls.
  - ⑬ **Export:** Allows you to export the currently selected folder or image to a storage device.
  - ⑭ **Save:** Saves the currently opened image.

Display settings and analysis tools



- ① **Image Display Settings:** Opens the Image display settings tool, which allows you to adjust image display parameters (Brightness , Contrast , Gamma Correction ) for the selected channels.

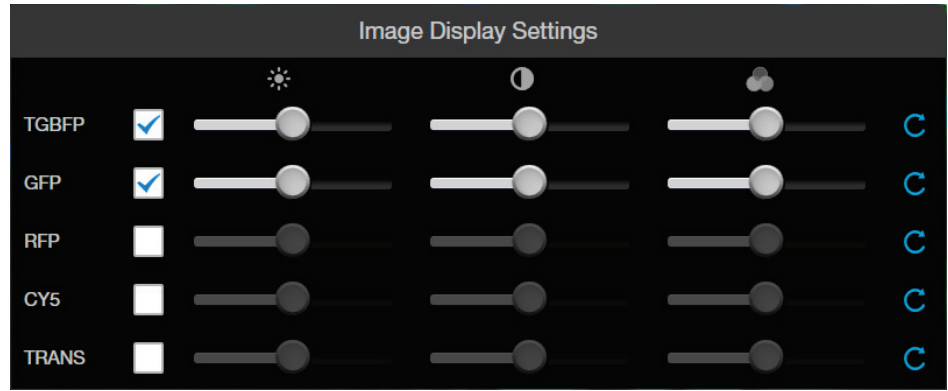

- ② **Display Grid/Grid Settings:** Display Grid button toggles the grid display in the Viewing area on and off. Grid Settings allows you to set the grid size.

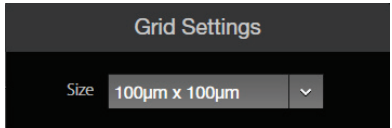

- ③ **Display Scale Bar/Scale Bar Settings:** Display Scale Bar button toggles the display of the scale bar in the Viewing area on and off. Scale Bar Settings allows you to select scale bar color and to display or hide end bars.

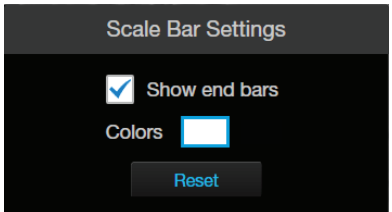

- ④ **Pixel Intensity:** Opens the Pixel Intensity window, which displays the Pixel count vs. Intensity histogram, where Intensity is a value based on the number of photons detected by the camera sensor.

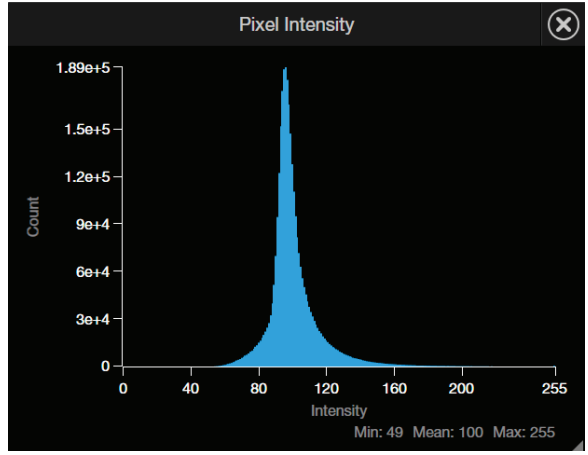

- ⑤ **Measurements and Annotations:** Allows you to draw regions of interest (rectangle, ellipse, polygon, line, or free-form) on the captured image and measure dimensions, area, or perimeter of the drawn region.

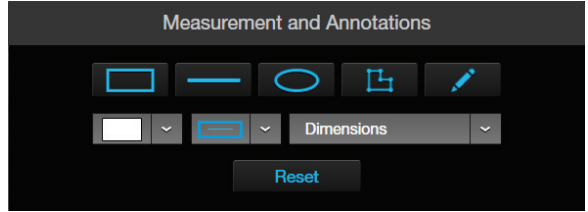

- ⑥ **Show Cell Count:** Allows you to perform cell counts and cell culture analysis.
- **Auto Count:** Allows you define auto count parameters by selecting representative target objects and background areas, then count the objects by intensity, area, and circularity (page 219). Auto Count is not supported for the transmitted light channel; it requires the image to be collected in a fluorescence nuclear stain channel.
  - **Manual Count:** Allows you to manually mark items onscreen using up to six separate labels and keep a running tally of the counts with percentages for each label (page 220).
  - **Cell Culture:** Allows you to select up to 5 reference objects each for target (i.e., cells) and background in your image to automatically measure the confluence of your culture, then calculate the transfection efficiency (fluorescence area divided by the entire cell area in the image) (page 221).

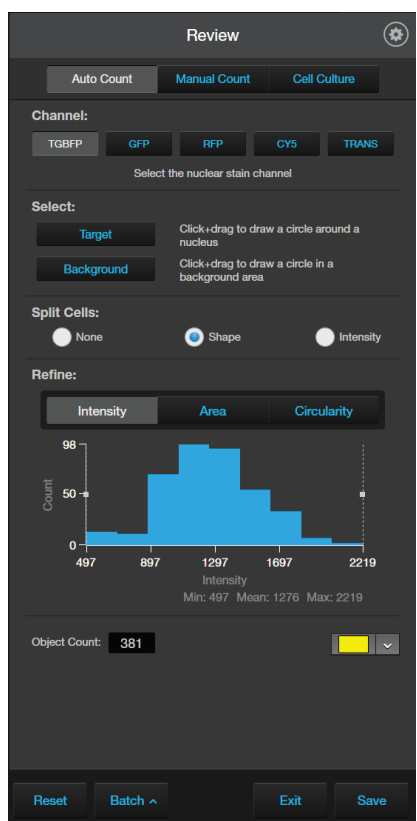

Auto Count

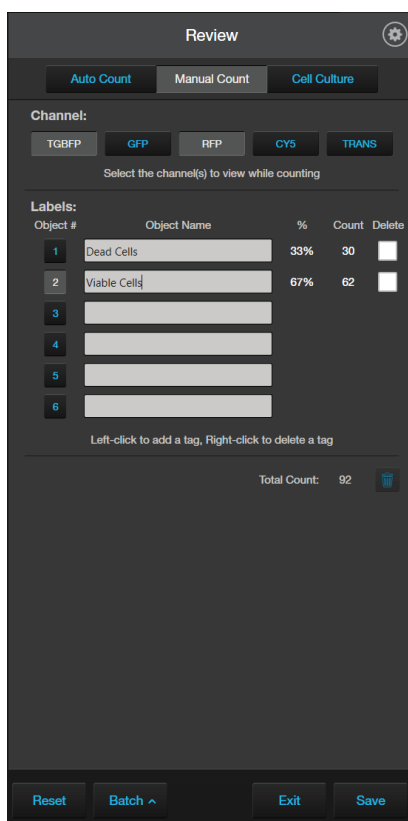

Manual Count

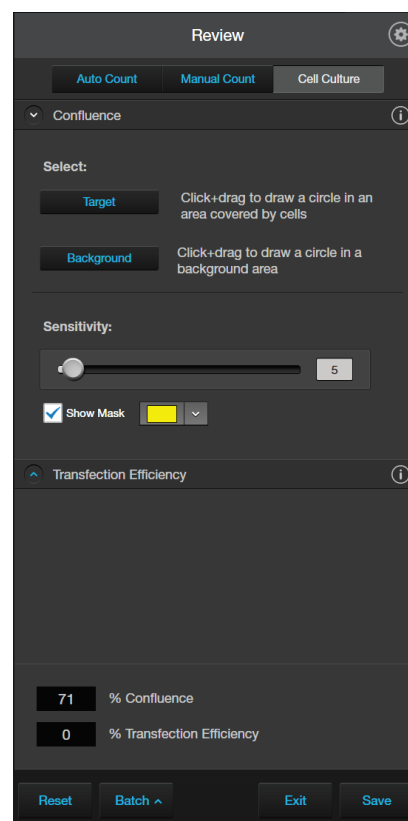

Cell Culture

- ⑦ **Toggle pseudocolor:** Allows you to display images in pseudocolor or in grayscale in the Viewing area. By default, color display is on.

## Auto Count controls

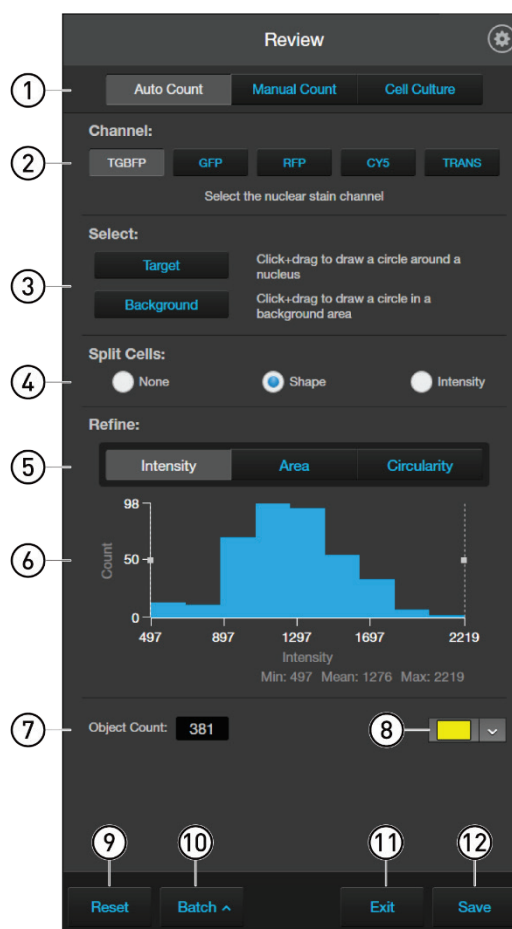

- ① **Analysis tools:** Allows you to toggle between Auto Count, Manual Count, or Cell Culture (Confluence and Transfection Efficiency) tools for image analysis.
- ② **Channel:** Selects the nuclear stain channel for Auto Count. You can select only a single channel.
- ③ **Select Target and Background:** Allows you to select representative target objects and background areas for Auto Count.
- ④ **Split Cells:** Allows you to split multiple objects that have been counted as one into individual objects based on shape or pixel intensity to increase the count accuracy.
- ⑤ **Refine:** Selects intensity, area, or circularity by which to refine Auto Count results using the Count Histogram.
- ⑥ **Count Histogram:** Allows you to set pixel intensity, area, or circularity thresholds to refine the Auto Count results.
- ⑦ **Object Count:** Displays the object count based on the Auto Count parameters.
- ⑧ **Object color:** Selects the color by which the counted objects are identified.
- ⑨ **Reset:** Resets the count to 0 and clears the selected targets and background areas.
- ⑩ **Batch Analysis:** Allows you to save and apply the analysis parameters to other images that you have collected and saved in an image folder (see page 100 for more information).
- ⑪ **Exit:** Exits the Auto Count tool and displays the Review tab.
- ⑫ **Save:** Saves the analysis results as an image in the selected file format (see page 98 for more information).

## Manual Count controls

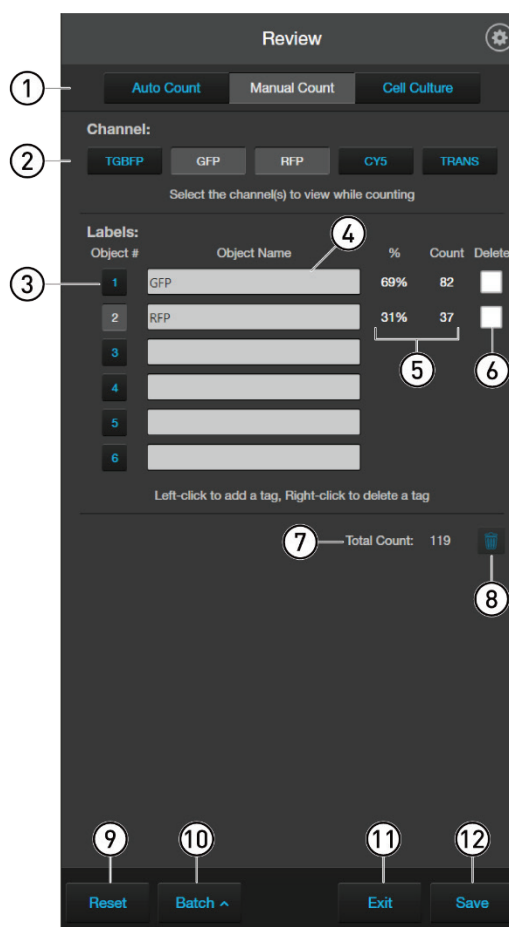

- ① **Analysis tools:** Allows you to toggle between Auto Count, Manual Count, or Cell Culture (Confluence and Transfection Efficiency) tools for image analysis.
- ② **Channel:** Selects the channels for Manual Count. You can select multiple channels.
- ③ **Object #:** Allows you to select the label (Object #) with which to tag objects in the Viewing area. Left-click on the objects in the Viewing area to tag them with the selected label; right-click to delete a tag. In this example, Object #2 is selected. You can switch labels as desired. See page 90 for more information.
- ④ **Object Name:** Allows you assign a name for the Object #.
- ⑤ **% and Count:** Displays the label count and its percentage of the total object count (total count of all labels).
- ⑥ **Delete:** Selects a label for deletion.
- ⑦ **Total Count:** Displays the total count of objects tagged with all labels.
- ⑧ **Trash:** Deletes the tags for the label and resets the label count to 0.
- ⑨ **Reset:** Resets all label counts and the total count to 0 and clears the Viewing area of all tags.
- ⑩ **Batch Analysis:** Allows you to save and apply the analysis parameters to other images that you have collected and saved in an image folder (see page 100 for more information).
- ⑪ **Exit:** Exits the Manual Count tool and displays the Review tab.
- ⑫ **Save:** Saves the analysis results as an image in the selected file format (see page 98 for more information).



## Cell Culture – Confluence controls

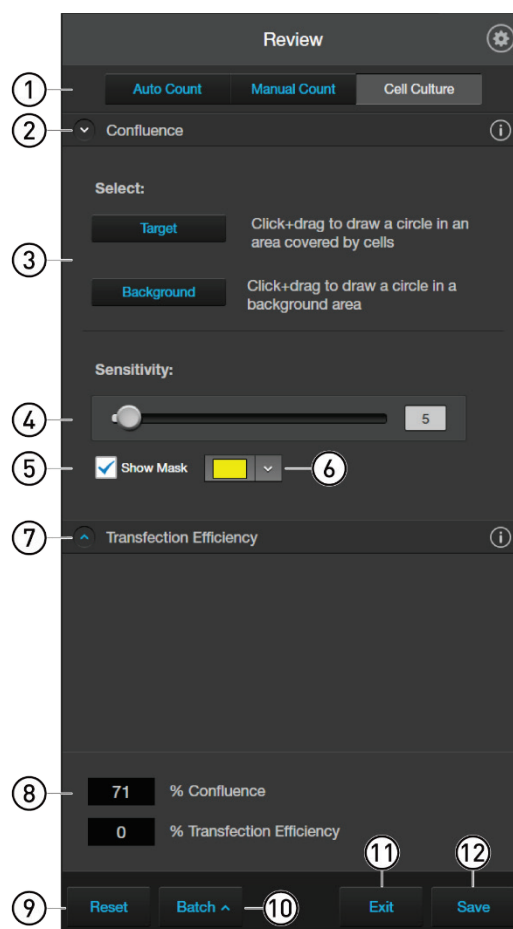

- ① **Analysis tools:** Allows you to toggle between Auto Count, Manual Count, or Cell Culture (Confluence and Transfection Efficiency) tools for image analysis.
- ② **Confluence:** Expands or hides the controls for the Confluence tool.
- ③ **Select Target and Background:** Allows you to select representative cell and background areas for the confluence measurement.
- ④ **Sensitivity:** Adjusts the algorithm sensitivity to pixel intensity (higher intensity = more pixels included). Decreasing the sensitivity reduces the confluence value.
- ⑤ **Show Mask:** Indicates the areas included in the confluence measurement.
- ⑥ **Mask Color:** Selects the mask color.
- ⑦ **Transfection Efficiency:** Expands or hides the controls for the Transfection Efficiency tool. The Transfection Efficiency tool is inactive until the confluence measurement is completed.
- ⑧ **% Confluence:** Displays the percentage of the area covered by cells in the image, based on the selected target and background areas and sensitivity.
- ⑨ **Reset:** Resets the Confluence and Transfection Efficiency measurements to 0 and clears the selected targets and background areas.
- ⑩ **Batch Analysis:** Allows you to save and apply the cell culture analysis parameters to other images that you have collected and saved in an image folder (see page 100).
- ⑪ **Exit:** Exits the Cell Culture tool and displays the Review tab.
- ⑫ **Save:** Saves the analysis results as an image in the selected file format (see page 98).



Cell Culture –  
 Transfection  
 Efficiency controls

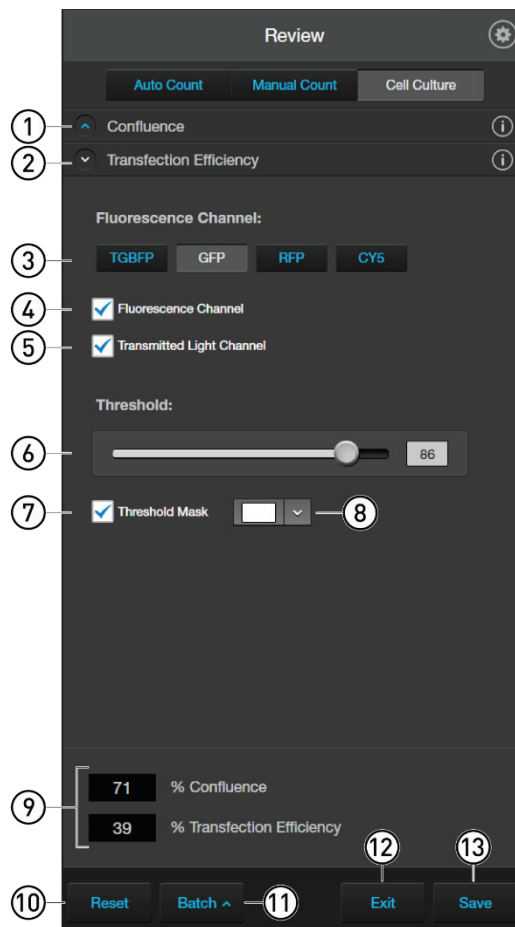

- ① **Confluence:** Expands or hides the controls for the Confluence tool.
- ② **Transfection Efficiency:** Expands or hides the controls for the Transfection Efficiency tool.
- ③ **Fluorescence Channel selection:** Selects the fluorescence channel for transfection efficiency calculation.
- ④ **Fluorescence Channel:** Toggles the display of the fluorescence channel.
- ⑤ **Transmitted Light Channel:** Toggles the display of the transmitted light.
- ⑥ **Threshold:** Adjusts the fluorescence threshold value. Only the cells that express above the set threshold are used in the tranfection efficiency calculation.
- ⑦ **Threshold Mask:** Indicates the areas above the set threshold value and are included in the transfection efficiency calculation.
- ⑧ **Mask Color:** Selects the threshold mask color.
- ⑨ **% Confluence and %Transfection Efficiency:** Displays the calculated confluence and transfection efficiency values.
- ⑩ **Reset:** Resets the Confluence and Transfection Efficiency measurements to 0 and clears the selected targets and background areas.
- ⑪ **Batch Analysis:** Allows you to save and apply the cell culture analysis parameters to other images that you have collected and saved in an image folder (see page 100).
- ⑫ **Exit:** Exits the Cell Culture tool and displays the Review tab.
- ⑬ **Save:** Saves the analysis results as an image in the selected file format (see page 98).

## Settings tab

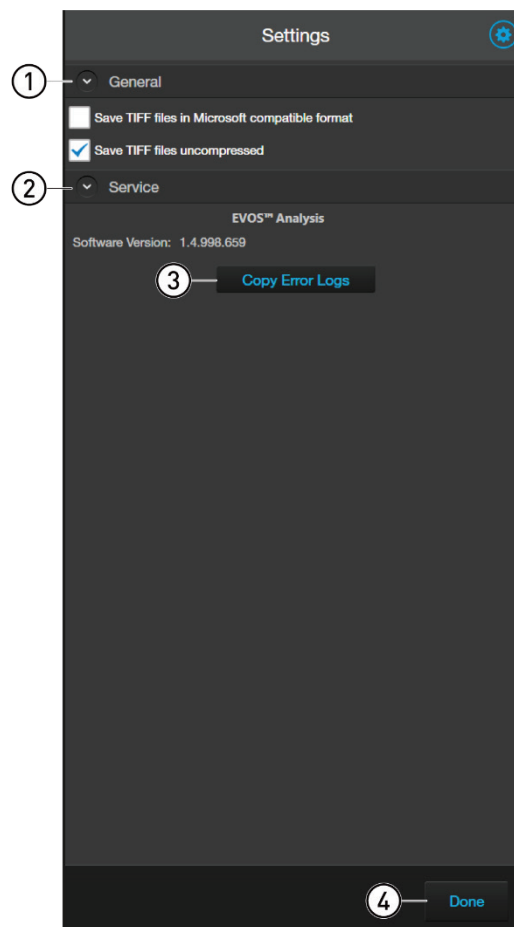

- ① **General:** Allows you to configure TIFF file saving options. You can select to save TIFF files in a Microsoft-compatible format (8-bit with reduced dynamic range), uncompressed (16-bit Raw format with no loss in image quality), or both.
- ② **Service:** Display the EVOS™ Analysis Software version.
- ③ **Copy Error Logs:** Allows you to copy error logs to an external storage device (USB drive).
- ④ **Done:** Saves your changes and returns to the Review tab.

## Appendix D: EVOS™ Onstage Incubator

---

### EVOS™ Onstage Incubator

The EVOS™ Onstage Incubator (Cat. No. AMC1000) is an optional accessory for the EVOS™ FL Auto Imaging System that enables the incubation of cells on the automatic X-Y stage, allowing the capture of images from the same sample over long periods of time and recording of time lapse movies.

The EVOS™ Onstage Incubator consists of a Stagetop Environmental Chamber that is placed on the automatic X-Y stage of the imaging system and a separate Control Unit that supplies the power and gas (air or air-CO<sub>2</sub> premix, CO<sub>2</sub>-only, and nitrogen-only). The onstage incubator is controlled by the same software and user interface that controls the EVOS™ M7000 Imaging System.

### Standard items included

- Stagetop Environmental Chamber
- Control unit
- Master Stage Plate (also available separately as EVOS™ Onstage Master Plate, Cat. No. AMEPVH035)
- Vessel holder for multi-well plates (also available separately as EVOS™ Onstage Vessel Holder, Multiwell Plates, Cat. No. AMEPVH028)
- Cable with 6-pin connector
- Cable, USB A-to-B, 180 cm/6 ft
- Heated hose with temperature control, 180 cm/6 ft (also available separately as EVOS™ Onstage Incubator Hose, Cat. No. AMEP4728)
- Gas line, 1/8 in ID, 1/4 in OD (also available separately as EVOS™ Onstage Incubator Gas Line, Cat. No. AMEP4732)
- Push-to-connect gas line adaptor (3 each)
- Standard-head open-end wrench
- Hex screw driver
- Power Cord, Type A (North America)

---

**Note:** A country-specific power cord must be ordered separately in regions not using the Type A power plug.

---

## Technical specifications

---

**Note:** Specifications of the Onstage Incubator are subject to change without notice. Refer to the EVOS™ product page at [www.thermofisher.com/evos](http://www.thermofisher.com/evos) for the latest product information.

---

### Physical characteristics

	<b>Stagetop Environmental Chamber</b>	<b>Control Unit</b>
<b>Height:</b>	25 cm (9.7 in)	37 cm (15 in)
<b>Depth:</b>	19 cm (7.6 in)	16 cm (6.3 in)
<b>Width:</b>	3.7 cm (1.5 in)	20 cm (7.9 in)
<b>Weight:</b>	1.5 kg (3.3 lb)	10 kg (22 lb)

**Temperature range:** Ambient to 40°C (± 0.1°C)

**Humidity:** >80% relative humidity (RH) at 37–40°C

**CO<sub>2</sub> range:** 0% to 20%

**O<sub>2</sub> range:** 0% to ambient

**Operating power:** 100–240 VAC, 1.8 A

**Frequency:** 50–60 Hz

**Electrical input:** 24 VDC, 5 A

### Hardware

**Compatible vessels:** Multi-well plates, 35-mm Petri dishes, T-25 flasks

**Gas input ports:** Air or air-CO<sub>2</sub> premix, CO<sub>2</sub>-only, and N<sub>2</sub>-only (max. 50 psi input)

**Stagetop environmental chamber accessories:** Master Stage Plate, Vessel holder for multi-well plates

# EVOS™ Onstage Incubator components

## Control unit and environmental chamber

EVOS™ Onstage Incubator consists of an environmental chamber and a separate control unit that supplies the power and gas (air or air-CO<sub>2</sub> premix, CO<sub>2</sub>, and N<sub>2</sub> for O<sub>2</sub> displacement in hypoxia experiments), and controls the humidity and temperature.



- ① Control unit
- ② Hose heater connector
- ③ Heated hose
- ④ Sensor data cable with 6-pin connector
- ⑤ Environmental chamber

## Control unit rear view

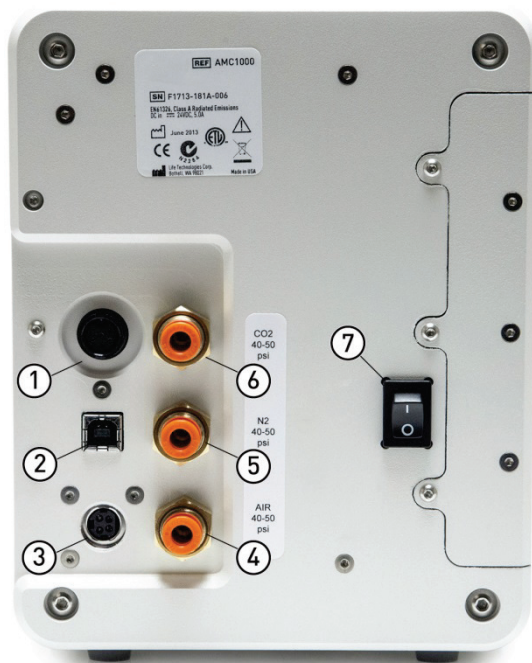

- ① Sensor data cable jack
- ② USB control cable jack
- ③ Power input jack
- ④ Port 1: Air
- ⑤ Port 2: N<sub>2</sub>
- ⑥ Port 3: CO<sub>2</sub>
- ⑦ Power switch

## Environmental chamber

The environmental chamber of the EVOS™ Onstage Incubator consists of the incubator chamber, the vessel holder/adaptor, the heated glass lid, the light shield, and the light shield cover.

The environmental chamber sits on the onstage incubator master plate attached to the X-Y stage of the EVOS™ M7000 Imaging System (see “Assemble the environmental chamber”, page 229).

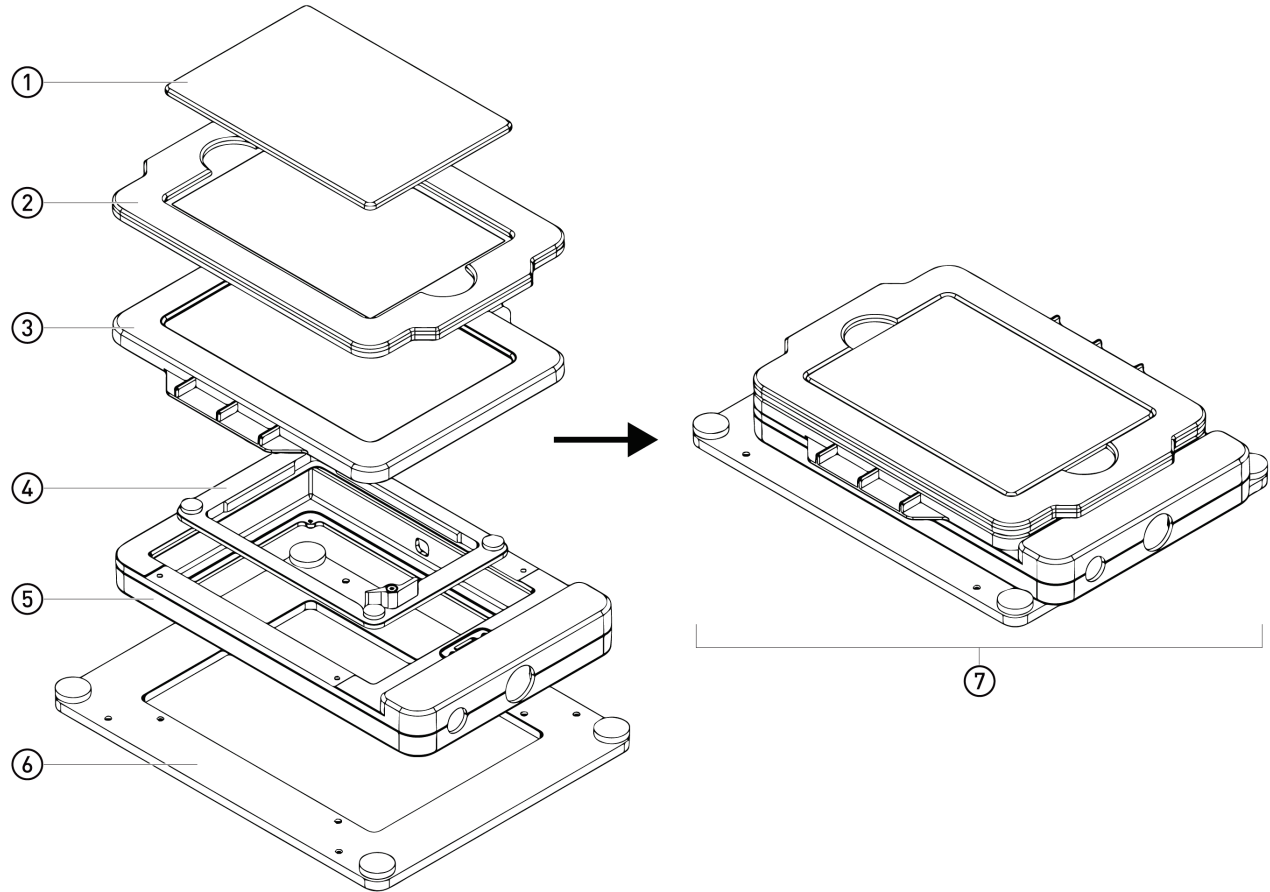

- ① Light shield cover
- ② Light shield
- ③ Heated glass lid
- ④ Vessel holder/adaptor
- ⑤ Incubator chamber
- ⑥ Master plate
- ⑦ Assembled environmental chamber

## Set up the EVOS™ Onstage Incubator

### Install the Onstage Incubator Master Plate

1. Remove the X-Y stage base plate ① from the X-Y stage by unscrewing the four 3.0-mm screws (indicated by red arrows) on the base plate ②. If necessary, unscrew and remove the vessel holder/adaptor ③ before removing the base plate.

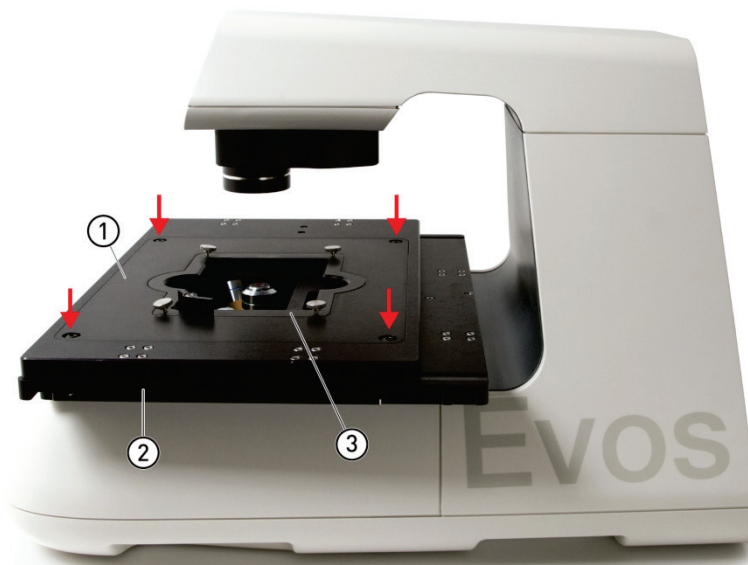

2. Secure the onstage incubator master plate ④ to the X-Y stage using the four thumb screws (indicated by red arrows).

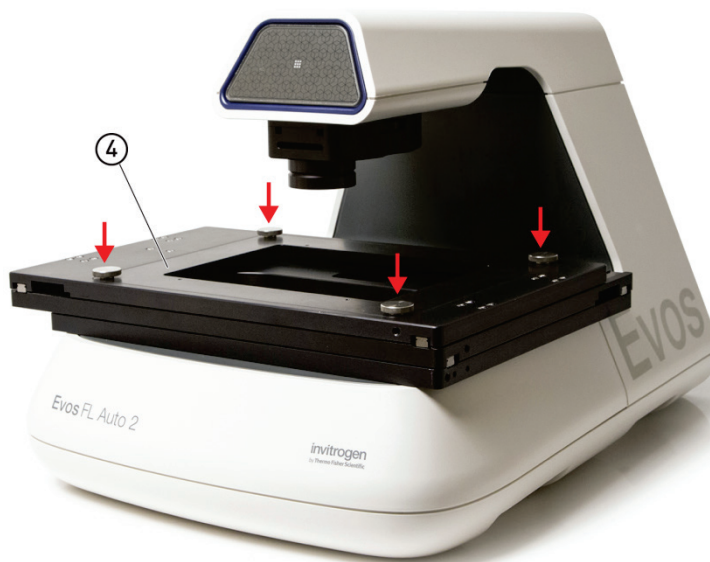

## Assemble the environmental chamber

1. Place the incubator chamber on the onstage incubator master plate and secure it in place using the four 2.0-mm hex screws (indicated by red arrows).

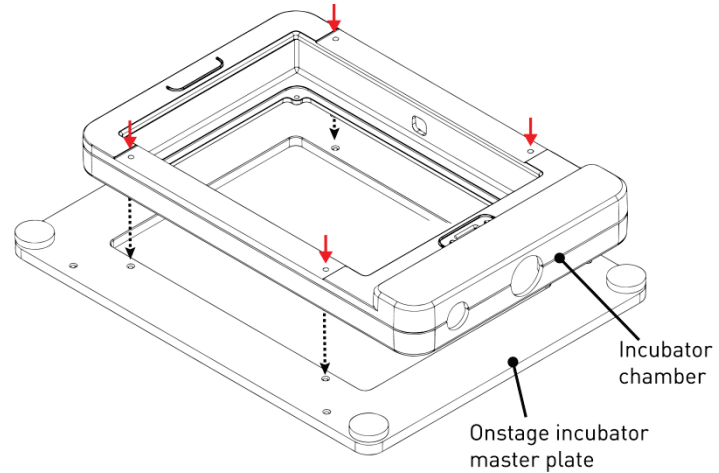

2. Attach the vessel holder/adaptor to the incubator chamber using the four thumb screws (indicated by red arrows).

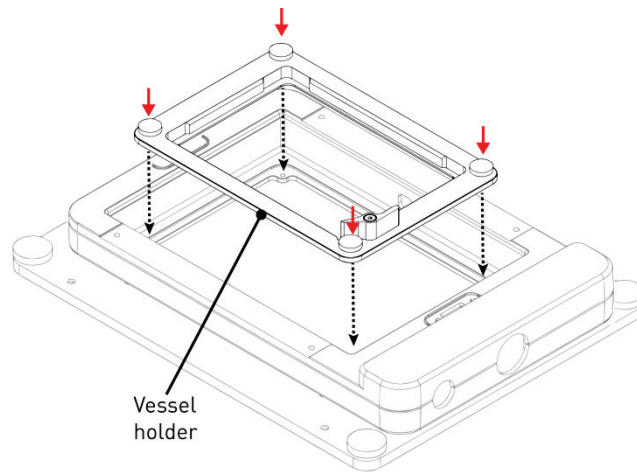

---

**Note:** Place an empty “dummy” culture plate into the vessel holder/adaptor for the initial warm up and equilibration to prevent build-up of condensation on the optical components and the inside of the EVOS™ M7000 Imaging System.

---



3. Place the heated glass lid with the no-fog glass window on the incubator chamber. The heated glass lid is guided and held secure in its place by the two magnets on its rim.

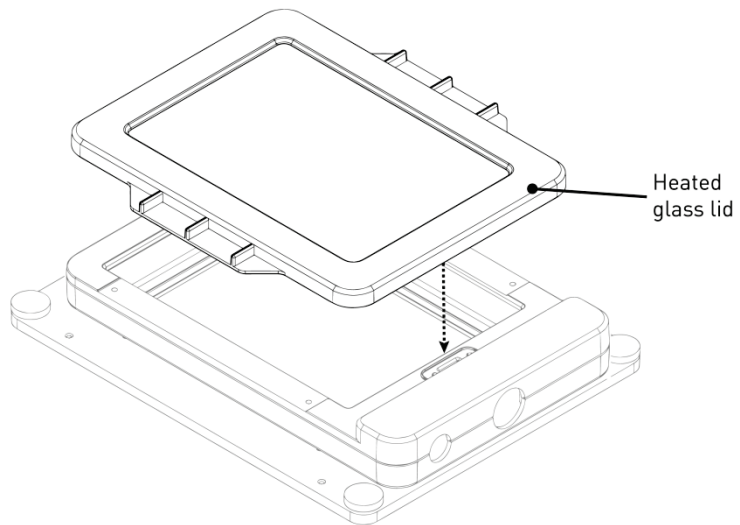

4. Place the light shield with tinted plastic window on top of the heated glass lid. **Use of the light shield is required for fluorescence imaging applications.**
5. If desired, place the light shield cover on the light shield for fluorescence imaging applications. The light shield cover completely blocks any ambient light from entering the environment chamber and improves image quality in fluorescence imaging applications.

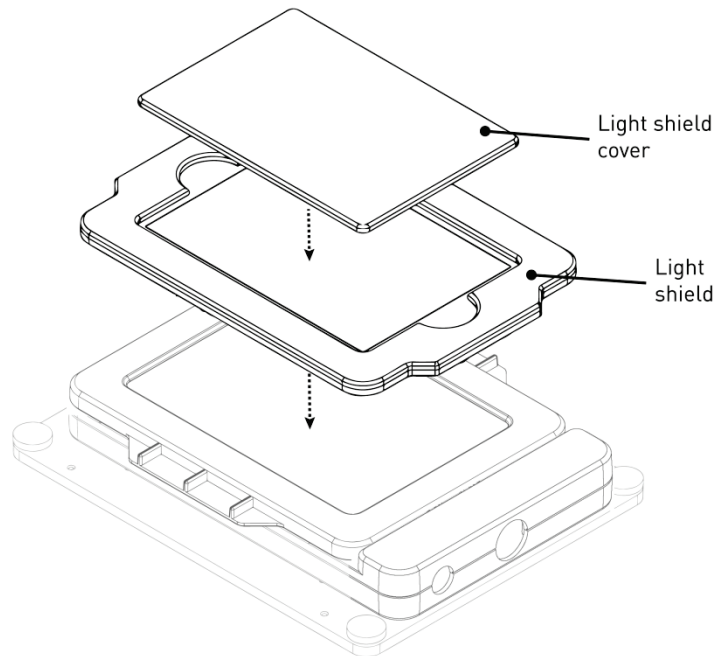

## Set up for operation

Follow the procedure below to set up the EVOS™ Onstage Incubator for operation. For the locations of the various input jacks and gas ports, refer to “Control unit rear view”, page 226.

---

**IMPORTANT!** Do not position the control unit so that it is difficult to turn off the main power switch. In case of an instrument malfunction, turn the main power switch to the OFF position and disconnect the power cord from the wall outlet.

---

1. Plug power cord into the power input jack on the control unit and the wall outlet.
2. Plug USB cable into the USB control cable jack on the control unit and the USB port on the computer.
3. Connect each gas line to the appropriate gas tank via the PTC (push-to-click) connectors threaded into the regulator. To do this, push the tubing into the PTC connector until it clicks into place. Pull on tubing slightly to ensure a tight connection; the tubing should not come out.

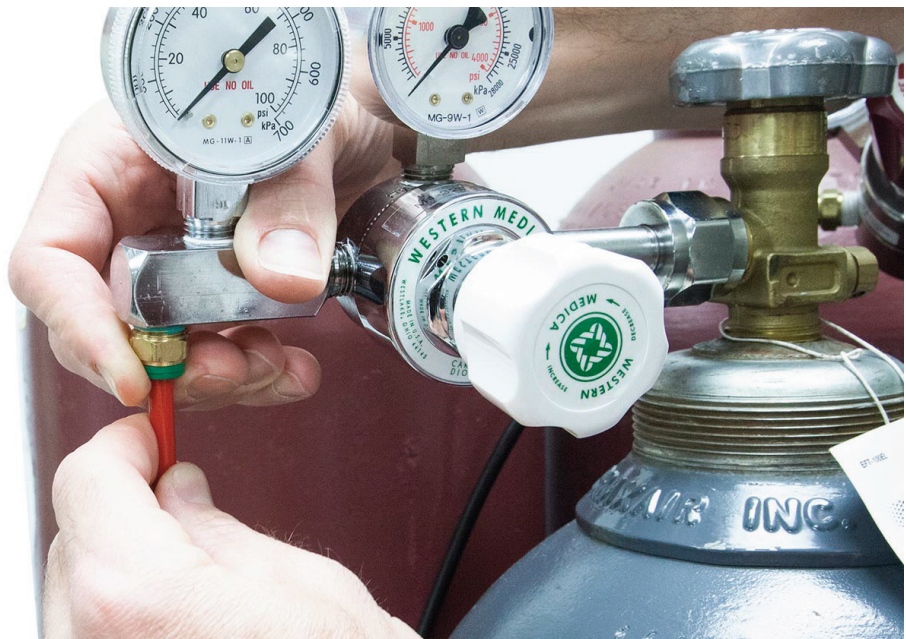

4. Attach the gas lines to the control unit via the PTC connectors for the appropriate gas intake port.
  - If using pre-mixed air, attach to **Port 1: Air In**
  - If using compressed air and CO<sub>2</sub>, attach to **Port 1: Air In** and **Port 3: CO<sub>2</sub> In**
  - For oxygen displacement, attach to **Port 1: Air In** and **Port 2: Nitrogen In**
5. Plug the 6-pin sensor data cable to the environmental chamber and the appropriate input jack on the control unit.

6. Assemble the water reservoir and add warm water (approximately 50°C) to the max fill line through the fill hole (see image below). **Do not overfill** the water reservoir.

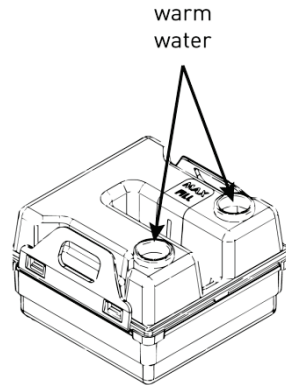

7. Place the water reservoir into the control unit **with the fill holes to the front** and close the lid.

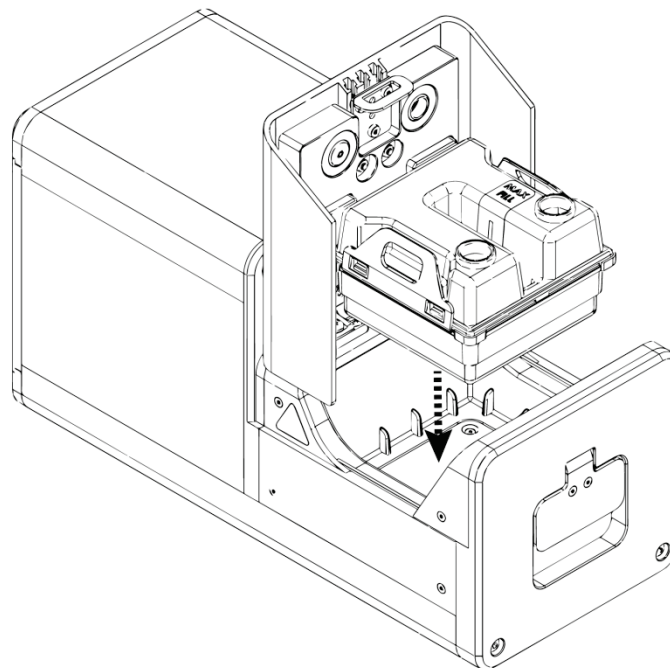

8. Attach the heated hose between the environmental chamber and the control unit
9. Plug the hose heater cable to the connector on the heated hose.

## Use the EVOS™ Onstage Incubator

### Turn ON the EVOS™ Onstage Incubator

1. Turn ON the EVOS™ M7000 Imaging System as described on page 18.
2. Turn the computer and monitor ON.
3. Turn ON the power switch to the control unit (page 226).
4. Restart the M7000 software.
5. On the **Capture** tab, click the **Incubator** button to display the Incubator control panel.
6. Select **Use Incubator**, then enter the target values for **Temperature**, **CO<sub>2</sub>**, and **Oxygen**. If desired, select **Use humidity**.
7. Select the desired **Shutdown** option:
  - **Turn off manually:** The incubator will remain on until the **Use Incubator** option is manually deselected and the **Apply** button is clicked.
  - **Turn off after:** Enter the time period in **hours** and **minutes** that must elapse before the incubator is shut down automatically.
8. Click **Apply**. Incubator status will change to “Running” and the control panel will display the Current, Target, and Actual values for Temperature, Humidity, CO<sub>2</sub>, and Oxygen.

Incubator

	Current	Target	Actual
Temperature	OK	37.0	36.5
Humidity	OK	Off	0.7
Co2	Adjusting...	5.0	0.2
Oxygen	Adjusting...	20.0	0.4

9. Click **Done** to return to the Capture tab.

---

**Note:** Place an empty “dummy” culture plate into the vessel holder/adaptor for the initial warm up and equilibration to prevent build-up of condensation on the optical components and the inside of the EVOS™ M7000 Imaging System.

---

## Configure gas inputs

1. In the **Settings** tab (page 192), click **Incubator** to open the incubator configuration panel.

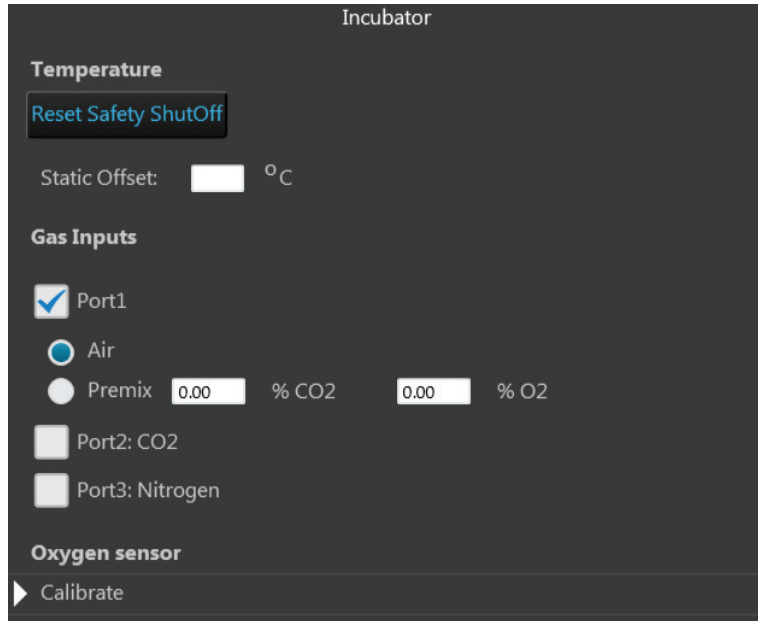

2. Select the appropriate options for the **Gas Inputs** that reflects your set-up for the EVOS™ Onstage Incubator.
  - For **Port 1**, you may select **Air** or **Premix**.  
If you select **Premix**, manually enter the percentage of the **CO<sub>2</sub>** and **O<sub>2</sub>** to reflect the specifics of your set-up.
  - **Port 2** is reserved for Nitrogen only.
  - **Port 3** is reserved for CO<sub>2</sub> only.
3. Click **Done** once you have configured the gas connections for each port.
4. Turn on the regulators on the gas tanks. The meters on the regulators show the tank fill on the right and gas flow on the left.
5. Set the flow on the regulators as follows. Do not exceed 50 psi of pressure.
  - **Air:** 40–50 psi
  - **CO<sub>2</sub>:** 40–50 psi
  - **Nitrogen:** 40–50 psi

## Calibrate oxygen sensor

Calibrating the oxygen sensor ensures that the atmosphere in the environmental chamber is replenished with the appropriate gasses in the correct proportion.

1. In the **Settings** tab (page 192), click **Incubator** to open the incubator configuration panel, then expand the **Calibrate** panel under **Oxygen Sensor**.

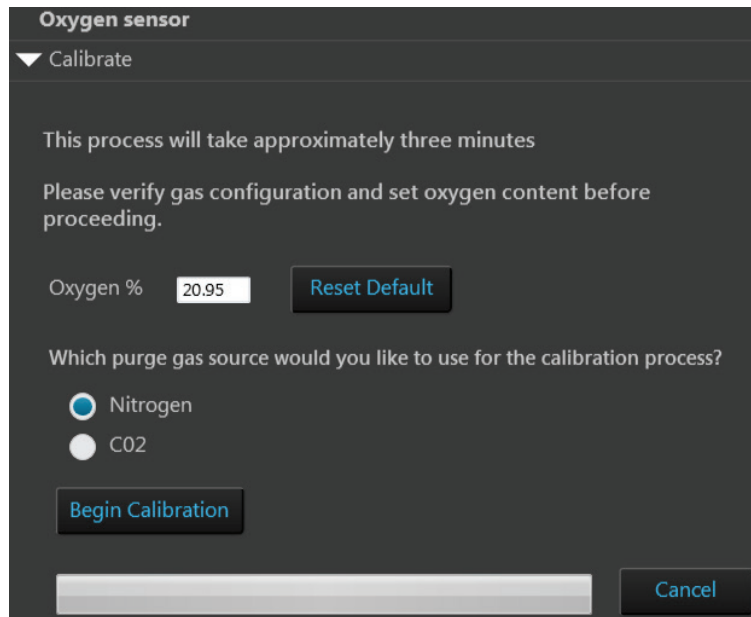

2. Verify that your gas connections have been correctly configured.
3. Verify that the **Oxygen %** has been set correctly. If not, enter the correct value for oxygen content.
4. Select the **purge gas source** for your calibration (**Nitrogen** or **CO<sub>2</sub>**).
5. Click **Begin Calibration**. The EVOS™ M7000 Imaging System automatically calibrates the oxygen sensor for the proper functioning of the EVOS™ Onstage Incubator. The entire calibration process takes approximately three minutes.

# Appendix E: Safety

---

## Safety conventions used in this document

**Safety alert words** Three safety alert words appear in this document at points where you need to be aware of relevant hazards. Each alert word—**CAUTION**, **WARNING**, **DANGER**—implies a particular level of observation or action, as defined below:



**CAUTION!** – Indicates a potentially hazardous situation that, if not avoided, may result in minor or moderate injury. It may also be used to alert against unsafe practices.

---



**WARNING!** – Indicates a potentially hazardous situation that, if not avoided, could result in death or serious injury.

---











**DANGER!** – Indicates an imminently hazardous situation that, if not avoided, will result in death or serious injury. This signal word is to be limited to the most extreme situations.

---

## Symbols on instruments

### Electrical symbols on instruments







The following table describes the electrical symbols that may be displayed on Thermo Fisher Scientific instruments.

Symbol	Description
	Indicates the <b>On</b> position of the main power switch.
	Indicates the <b>Off</b> position of the main power switch.
	Indicates a standby switch by which the instrument is switched on to the <b>Standby</b> condition. Hazardous voltage may be present if this switch is on standby.
	Indicates the <b>On/Off</b> position of a push-push main power switch.
	Indicates a terminal that may be connected to the signal ground reference of another instrument. This is not a protected ground terminal.
	Indicates a protective grounding terminal that must be connected to earth ground before any other electrical connections are made to the instrument.
	Indicates a terminal that can receive or supply alternating current or voltage.
	Indicates a terminal that can receive or supply alternating or direct current or voltage.



## Safety symbols

The following table describes the safety symbols that may be displayed on Thermo Fisher Scientific instruments. Each symbol may appear by itself or in combination with text that explains the relevant hazard (see “Safety labels on instruments”). These safety symbols may also appear next to **DANGERS**, **WARNINGS**, and **CAUTIONS** that occur in the text of this and other product-support documents.

Symbol	Description
	Indicates that you should consult the manual for further information and to proceed with appropriate caution.
	Indicates the presence of an electrical shock hazard and to proceed with appropriate caution.
	Indicates the presence of a hot surface or other high-temperature hazard and to proceed with appropriate caution.
	Indicates the presence of a laser inside the instrument and to proceed with appropriate caution.
	Indicates the presence of moving parts and to proceed with appropriate caution.
	Indicates the presence of a biological hazard and to proceed with appropriate caution.
	Indicates the presence of an ultraviolet light and to proceed with appropriate caution.





## Environmental symbols on instruments

The following symbol applies to all Thermo Fisher Scientific electrical and electronic products placed on the European market after August 13, 2005.

Symbol	Description
	<p><b>Do not dispose of this product as unsorted municipal waste.</b> Follow local municipal waste ordinances for proper disposal provisions to reduce the environmental impact of waste electrical and electronic equipment (WEEE).</p> <p><b>European Union customers:</b> Call your Customer Service representative for equipment pick-up and recycling. See <a href="http://www.thermofisher.com">www.thermofisher.com</a> for a list of customer service offices in the European Union.</p>

## Safety labels on instruments

The following CAUTION, WARNING, and DANGER statements may be displayed on Thermo Fisher Scientific instruments in combination with the safety symbols described in the preceding section.

Hazard Symbol	English	Français
	<b>CAUTION!</b> Hazardous chemicals. Read the Safety Data Sheets (SDSs) before handling.	<b>ATTENTION!</b> Produits chimiques dangereux. Lire les fiches techniques de sûreté de matériels avant toute manipulation de produits.
	<b>CAUTION! HAZARDOUS WASTE.</b> Refer to SDS(s) and local regulations for handling and disposal.	<b>ATTENTION!</b> Déchets dangereux. Lire les fiches techniques de sûreté de matériels et la réglementation locale associées à la manipulation et l'élimination des déchets.
	<b>DANGER!</b> High voltage.	<b>DANGER!</b> Haute tension.
	<b>WARNING!</b> To reduce the chance of electrical shock, do not remove covers that require tool access. No user-serviceable parts are inside. Refer servicing to Thermo Fisher Scientific qualified service personnel.	<b>AVERTISSEMENT!</b> Pour éviter les risques d'électrocution, ne pas retirer les capots dont l'ouverture nécessite l'utilisation d'outils. L'instrument ne contient aucune pièce réparable par l'utilisateur. Toute intervention doit être effectuée par le personnel de service qualifié venant de chez Thermo Fisher Scientific.
	<b>DANGER!</b> Class 3B visible and/or invisible laser radiation present when open. Avoid exposure to beam.	<b>DANGER!</b> Rayonnement visible ou invisible d'un faisceau laser de Classe 3B en cas d'ouverture. Evitez toute exposition au faisceau.
	<b>CAUTION!</b> Moving parts. Crush/pinch hazard.	<b>ATTENTION!</b> Pièces en mouvement, risque de pincement et/ou d'écrasement.

## General instrument safety



**WARNING! PHYSICAL INJURY HAZARD.** Use this product only as specified in this document. Using this instrument in a manner not specified by Thermo Fisher Scientific may result in personal injury or damage to the instrument.

---

### Moving and lifting the instrument



**CAUTION! PHYSICAL INJURY HAZARD.** The instrument is to be moved and positioned only by the personnel or vendor specified in the applicable site preparation guide. If you decide to lift or move the instrument after it has been installed, do not attempt to lift or move the instrument without the assistance of others, the use of appropriate moving equipment, and proper lifting techniques. Improper lifting can cause painful and permanent back injury. Depending on the weight, moving or lifting an instrument may require two or more persons.

---

### Moving and lifting stand-alone computers and monitors



**WARNING!** Do not attempt to lift or move the computer or the monitor without the assistance of others. Depending on the weight of the computer and/or the monitor, moving them may require two or more people.

---

#### Things to consider before lifting the computer and/or the monitor:

- Make sure that you have a secure, comfortable grip on the computer or the monitor when lifting.
- Make sure that the path from where the object is to where it is being moved is clear of obstructions.
- Do not lift an object and twist your torso at the same time.
- Keep your spine in a good neutral position while lifting with your legs.
- Participants should coordinate lift and move intentions with each other before lifting and carrying.
- Instead of lifting the object from the packing box, carefully tilt the box on its side and hold it stationary while someone slides the contents out of the box.

### Operating the instrument

Ensure that anyone who operates the instrument has:

- Received instructions in both general safety practices for laboratories and specific safety practices for the instrument.
- Read and understood all applicable Safety Data Sheets (SDSs). See “Safety Data Sheets (SDS)”.

### Cleaning or decontaminating the instrument



**CAUTION!** Using cleaning or decontamination methods other than those recommended by the manufacturer may compromise the safety or quality of the instrument.

---

### Removing covers or parts of the instrument



**CAUTION! PHYSICAL INJURY HAZARD.** The instrument is to be serviced only by trained personnel or vendor specified in the user guide. Do not remove any covers or parts that require the use of a tool to obtain access to moving parts. Operators must be trained before being allowed to perform the hazardous operation.

---

# Safety requirements for EVOS™ Onstage Incubator



**WARNING!** Thermo Fisher Scientific recommends the use of nitrogen, oxygen, and carbon dioxide gas with the Onstage Incubator. The use of alternative gasses is currently not supported and may adversely affect system performance

---

## Gas cylinders

You must supply the required nitrogen, oxygen, and carbon dioxide gas cylinders and accessories for the installation. This instrument requires pressurized house lines, or one size 1-A gas cylinder that holds approximately 7.2 m<sup>3</sup> (257 ft<sup>3</sup>) of gas when full for each gas. Use only pre-purified gasses of 99.9% or greater purity.

---



**CAUTION!** Damage to the instrument and its products can result from using impure gas, gases other than specified, or an inadequate amount of gas.

---



**WARNING! EXPLOSION HAZARD.** Pressurized gas cylinders are potentially explosive. Always cap the gas cylinder when it is not in use, and attach it firmly to the wall or gas cylinder cart with approved brackets or chains.

---



**WARNING!** Gas cylinders are heavy and may topple over, potentially causing personal injury and tank damage. Cylinders should be firmly secured to a wall or work surface. Please contact your environmental health and safety coordinator for guidance on the proper installation of a gas cylinder.

---

## Pressure regulator

You must supply a two-gauge regulator with a Compressed Gas Association (CGA) 580-cylinder adaptor on the inlet side and a Swagelok™-type end-fitting that accepts 6.35-mm (0.25-in.) o.d. tubing. The primary gauge (0 to 3000 psi; 0 to 25,000 kPa recommended) measures tank pressure, and the secondary gauge (0 to 200 psi; 0 to 2000 kPa recommended) measures regulated pressure. The secondary gauge must allow regulation to 50 psi. Compressed Gas Association (CGA) 580-cylinder adaptor with a needle-type shutoff valve on the exit side. The needle valves should have Swagelok™-type end-fittings ready for connection to 6.35-mm (0.25-in.) o.d. tubing.

## Attaching the cylinder

Attach the pressurized gas cylinder firmly to a wall or gas cylinder cart by means of approved straps or chains.

---

## Ventilation requirements



**WARNING!** The Onstage Incubator should be installed and operated in a well-ventilated environment as defined as having a minimum airflow of 6–10 air changes per hour. Please contact your environmental health and safety coordinator to confirm that the Ion instruments will be installed and operated in an environment with sufficient ventilation.

---

## Ventilation requirements

Allow at least 50 cm (20 in) of clearance around the Instrument for ventilation.

## Chemical safety

### Chemical hazard warning



---

**WARNING! CHEMICAL HAZARD.** Before handling any chemicals, refer to the Safety Data Sheet (SDS) provided by the manufacturer, and observe all relevant precautions.

---



**WARNING! CHEMICAL HAZARD.** All chemicals in the instrument, including liquid in the lines, are potentially hazardous. Always determine what chemicals have been used in the instrument before changing reagents or instrument components. Wear appropriate eyewear, protective clothing, and gloves when working on the instrument.

---



**WARNING! CHEMICAL STORAGE HAZARD.** Never collect or store waste in a glass container because of the risk of breaking or shattering. Reagent and waste bottles can crack and leak. Each waste bottle should be secured in a low-density polyethylene safety container with the cover fastened and the handles locked in the upright position. Wear appropriate eyewear, clothing, and gloves when handling reagent and waste bottles.

---

### General safety guidelines

To minimize the hazards of chemicals:

- Read and understand the Safety Data Sheets (SDSs) provided by the chemical manufacturer before you store, handle, or work with any chemicals or hazardous materials. (See “Safety Data Sheets (SDS)”)
- Minimize contact with chemicals. Wear appropriate personal protective equipment when handling chemicals (for example, safety glasses, gloves, or protective clothing). For additional safety guidelines, consult the SDS.
- Minimize the inhalation of chemicals. Do not leave chemical containers open. Use only with adequate ventilation (for example, fume hood). For additional safety guidelines, consult the SDS.
- Check regularly for chemical leaks or spills. If a leak or spill occurs, follow the manufacturer’s cleanup procedures as recommended in the SDS.
- Comply with all local, state/provincial, or national laws and regulations related to chemical storage, handling, and disposal.

# Chemical waste safety

## Chemical waste hazard



**CAUTION! HAZARDOUS WASTE.** Refer to Safety Data Sheets (SDSs) and local regulations for handling and disposal.

---

## Chemical waste safety guidelines

To minimize the hazards of chemical waste:

- Read and understand the Safety Data Sheets (SDSs) provided by the manufacturers of the chemicals in the waste container before you store, handle, or dispose of chemical waste.
- Provide primary and secondary waste containers. (A primary waste container holds the immediate waste. A secondary container contains spills or leaks from the primary container. Both containers must be compatible with the waste material and meet federal, state, and local requirements for container storage.)
- Minimize contact with chemicals. Wear appropriate personal protective equipment when handling chemicals (for example, safety glasses, gloves, or protective clothing). For additional safety guidelines, consult the SDS.
- Minimize the inhalation of chemicals. Do not leave chemical containers open. Use only with adequate ventilation (for example, fume hood). For additional safety guidelines, consult the SDS.
- Handle chemical wastes in a fume hood.
- After emptying the waste container, seal it with the cap provided.
- Dispose of the contents of the waste tray and waste bottle in accordance with good laboratory practices and local, state/provincial, or national environmental and health regulations.

## Waste disposal

If potentially hazardous waste is generated when you operate the instrument, you must:

- Characterize (by analysis, if necessary) the waste generated by the particular applications, reagents, and substrates used in your laboratory.
- Ensure the health and safety of all personnel in your laboratory.
- Ensure that the instrument waste is stored, transferred, transported, and disposed of according to all local, state/provincial, and/or national regulations.







**IMPORTANT!** Radioactive or biohazardous materials may require special handling, and disposal limitations may apply.

---

## Electrical safety

---

	 <b>DANGER! ELECTRICAL SHOCK HAZARD.</b> Severe electrical shock can result from operating the EVOS™ M7000 Imaging System without its instrument panels in place. Do not remove instrument panels. High-voltage contacts are exposed when instrument panels are removed from the instrument.
<b>Fuses</b>	 <b>WARNING! FIRE HAZARD.</b> For continued protection against the risk of fire, replace fuses only with fuses of the type and rating specified for the instrument.
<b>Power</b>	 <b>DANGER! ELECTRICAL HAZARD.</b> Grounding circuit continuity is vital for the safe operation of equipment. Never operate equipment with the grounding conductor disconnected.
	 <b>DANGER! ELECTRICAL HAZARD.</b> Use properly configured and approved line cords for the voltage supply in your facility.
	 <b>DANGER! ELECTRICAL HAZARD.</b> Plug the system into a properly grounded receptacle with adequate current capacity.
<b>Overvoltage rating</b>	The EVOS™ M7000 Imaging System has an installation (overvoltage) category of II, and is classified as portable equipment.

---

## Physical hazard safety

### Moving parts



**WARNING! PHYSICAL INJURY HAZARD.** Moving parts can crush and cut. Keep hands clear of moving parts while operating the instrument. Disconnect power before servicing the instrument.

## Biological hazard safety



**WARNING! BIOHAZARD.** Biological samples such as tissues, body fluids, and blood of humans and other animals have the potential to transmit infectious diseases. Follow all applicable local, state/provincial, and/or national regulations. Wear appropriate protective eyewear, clothing, and gloves. Read and follow the guidelines in these publications.

**ATTENTION! BIOHAZARD.** Les échantillons biologiques tels que les tissus, les fluides corporels et le sang des humains et d'autres animaux ont la possibilité de transmettre des maladies infectieuses. Suivre tous les règlements municipaux, provinciaux/provincial et / ou nationales en vigueur. Porter des lunettes de protection approprié, des vêtements et des gants.

### In the U.S.:

- U.S. Department of Health and Human Services guidelines published in *Biosafety in Microbiological and Biomedical Laboratories* (stock no. 017-040-00547-4; [www.cdc.gov/OD/ohs/biosfty/bmb14/bmb14toc.htm](http://www.cdc.gov/OD/ohs/biosfty/bmb14/bmb14toc.htm))
- Occupational Safety and Health Standards, Bloodborne Pathogens (29 CFR§1910.1030; [www.access.gpo.gov/nara/cfr/waisidx\\_01/29cfr1910a\\_01.html](http://www.access.gpo.gov/nara/cfr/waisidx_01/29cfr1910a_01.html))
- Your company's/institution's Biosafety Program protocols for working with/handling potentially infectious materials.
- Additional information about biohazard guidelines is available at: [www.cdc.gov](http://www.cdc.gov)

### In the EU:

- Check your local guidelines and legislation on biohazard and biosafety precaution, and the best practices published in the World Health Organisation (WHO) Laboratory Biosafety Manual, third edition [www.who.int/csr/resources/publications/biosafety/WHO\\_CDS\\_CSR\\_LYO\\_2004\\_11/en/](http://www.who.int/csr/resources/publications/biosafety/WHO_CDS_CSR_LYO_2004_11/en/)



## Safety and electromagnetic compatibility (EMC) standards

This section provides information on:

- U.S. and Canadian safety standards
- European safety and EMC standards
- Australian EMC standards

### U.S. and Canadian safety standards



The **CSA C/US Mark** signifies that the product meets applicable U.S. and Canadian standards, including those from CSA, CSA America, ANSI, ASME, ASSE, ASTM, NSF and UL.

### European safety and EMC standards



The **CE Mark** symbolizes that the product conforms to all applicable European Community provisions for which this marking is required. Operation of the instrument is subject to the conditions described in this manual.

The protection provided by the instrument may be impaired if the instrument is used in a manner not specified by Thermo Fisher Scientific.

### Australian EMC standards



The **C-Tick Mark** indicates conformity with Australian and New Zealand standards for electromagnetic compatibility.

# Documentation and support

---

## Obtaining support

- Technical support** For the latest services and support information for all locations, visit [www.thermofisher.com](http://www.thermofisher.com).
- At the website, you can:
- Access worldwide telephone and fax numbers to contact Technical Support and Sales facilities
  - Search through frequently asked questions (FAQs)
  - Submit a question directly to Technical Support ([thermofisher.com/contact](http://www.thermofisher.com/contact))
  - Search for user documents, SDSs, vector maps and sequences, application notes, formulations, handbooks, certificates of analysis, citations, and other product support documents
  - Obtain information about customer training
  - Download software updates and patches
- Limited product warranty** Life Technologies Corporation and/or its affiliate(s) warrant their products as set forth in the Life Technologies' General Terms and Conditions of Sale found on Life Technologies' website at [www.thermofisher.com/us/en/home/global/terms-and-conditions.html](http://www.thermofisher.com/us/en/home/global/terms-and-conditions.html). If you have any questions, please contact Life Technologies at [www.thermofisher.com/support](http://www.thermofisher.com/support).



**IMPORTANT!** Wiping the computer supplied with the EVOS™ M7000 Imaging System (i.e., erasing the hard drive to remove all programs, files, and the operating system) voids the product warranty.

---

For support visit [thermofisher.com/support](https://www.thermofisher.com/support) or email [techsupport@lifetech.com](mailto:techsupport@lifetech.com)

16 February 2021

**ThermoFisher**  
SCIENTIFIC