



Instructions for Use – Reference Guide

# SPARK



Document Part No.: 30104686

2016-05

Document Version: 1.1



30104686 01



**WARNING:** Carefully read and follow the instructions provided in this document before operating the instrument.

## Notice

Every effort has been made to avoid errors in text and diagrams; however, Tecan Austria GmbH assumes no responsibility for any errors, which may appear in this publication.

It is the policy of Tecan Austria GmbH to improve products as new techniques and components become available. Tecan Austria GmbH therefore reserves the right to change specifications at any time with appropriate validation, verification, and approvals.

We would appreciate any comments on this publication.



Manufacturer  
Tecan Austria GmbH  
Untersbergstr. 1A  
A-5082 Grödig  
T +43 62 46 89 330  
F +43 62 46 72 770  
E-mail: [office.austria@tecan.com](mailto:office.austria@tecan.com)  
[www.tecan.com](http://www.tecan.com)

## Copyright Information

The contents of this document are the property of Tecan Austria GmbH and are not to be copied, reproduced or transferred to another person or persons without prior written permission.

Copyright © Tecan Austria GmbH  
All rights reserved.  
Printed in Austria

## CE Declaration of Conformity

See the last page of these Instructions for Use.

## Area of Application – Intended Use

See chapter 2.2 Intended Use (Hardware and Software).

## About the Instructions for Use

Original Instructions. This document describes the SPARK multifunctional microplate reader. It is intended as reference and instructions for use. This document describes how to:

- Install the instrument
- Operate the instrument
- Clean and maintain the instrument

## Remarks on Screenshots

The version number displayed in screenshots may not always be the one of the currently released version. Screenshots are replaced only if content related to the application has changed.

## Trademarks

The following product names and any registered and unregistered trademarks mentioned in this document are used for identification purposes only and remain the exclusive property of their respective owners:

- Spark™, SparkControl™, Magellan™, NanoQuant™, Tecan® and the Tecan Logo are registered trademarks of Tecan Group Ltd., Männedorf, Switzerland
- Windows® and Excel® are registered trademarks of Microsoft Corporation, Redmond, WA, USA
- Greiner® is registered trademarks of Greiner Labortechnik GmbH, Frickenhausen, Germany
- Chroma-Glo™ is a registered trademark of Promega Corporation Madison, WI, USA
- BRET2™, and PerkinElmer® are registered trademarks of PerkinElmer, Inc., Waltham, Massachusetts, USA
- HTRF® is a registered trademark of Cisbio Bioassays, Parc Marcel Boiteux, 30200 Codolet, France
- AlphaScreen®, AlphaLISA® and AlphaPlex™ are registered trademarks of PerkinElmer, Inc., Waltham, Massachusetts, USA
- RoboFlask® is a registered trademark of Corning, Inc., New York, USA

## Warnings, Cautions, and Notes

The following types of notices are used in this publication to highlight important information or to warn the user of a potentially dangerous situation:



**NOTE:** Gives helpful information.



**CAUTION:** Indicates a possibility of instrument damage or data loss if instructions are not followed.



**WARNING:** Indicates the possibility of severe personal injury, loss of life or equipment damage if the instructions are not followed.



**WARNING:** This symbol indicates the possible presence of biologically hazardous material. Proper laboratory safety precautions must be observed.



**WARNING:** This symbol indicates the possible presence of flammable materials and a risk of fire. Proper laboratory safety precautions must be observed.















**ATTENTION:** Negative environmental impacts associated with the treatment of waste (WEEE).

- Do not treat electrical and electronic equipment as unsorted municipal waste
- Collect waste electrical and electronic equipment separately



**WARNING:** Indicates laser. Do not stare into the beam!

## Symbols

	Conformité Européenne
	Date of Manufacture
	Manufactured by
	Order Number
	Read the Instructions for Use before operating the instrument
	China RoHS symbol
	Serial Number
	Single use only
	TÜV Label
	USB Label
	Use by
	WEEE Symbol

# Table of Contents

<b>1</b>	<b>Safety .....</b>	<b>13</b>
1.1	Introduction .....	13
<b>2</b>	<b>General Description .....</b>	<b>15</b>
2.1	Instrument.....	15
2.2	Intended Use (Hardware and Software) .....	15
2.3	User Profile.....	16
2.3.1	Professional User – Administrator Level .....	16
2.3.2	End User or Routine User.....	16
2.3.3	Service Technician .....	16
2.4	Multifunctionality .....	16
2.5	Microplate Requirements.....	17
2.6	Onboard Control Buttons.....	18
2.7	Instrument LEDs.....	19
2.8	Rear View .....	20
2.9	Instrument Dimensions .....	22
<b>3</b>	<b>Instrument Installation.....</b>	<b>31</b>
3.1	Installing the SPARK .....	31
3.2	Installation Requirements for SPARK.....	31
3.2.1	Required Working Area.....	31
3.3	Unpacking & Inspection .....	32
3.4	Power Requirements .....	32
3.5	Subpacks .....	33
3.6	Options Packages.....	34
3.7	Removal of the Transport Locks .....	35
3.7.1	Plate Carrier Transport Lock.....	35
3.8	Switching the Instrument On.....	37
3.9	Switching the Instrument Off.....	38
3.10	Preparing the Instrument for Shipping .....	38
3.10.1	Parking Procedure .....	39
3.10.2	Installing the Plate Carrier Transport Locks.....	39
<b>4</b>	<b>Plate Control .....</b>	<b>43</b>
4.1	Z-Position .....	44
4.2	Shaking.....	44
4.3	Incubation/Cooling Position .....	44
4.4	Lid Lifter.....	44
4.5	Securing the RoboFlask Cell Culture Vessels .....	45
<b>5</b>	<b>Spark Platform .....</b>	<b>47</b>
5.1	Overview of Available Modules and Functions for SPARK 10M .....	47
5.2	Overview of Available Modules and Functions for SPARK 20M .....	48
<b>6</b>	<b>Instrument Specifications .....</b>	<b>51</b>
<b>7</b>	<b>Cleaning and Maintenance.....</b>	<b>53</b>
7.1	Introduction.....	53
7.2	Liquid Spills.....	53
7.3	Instrument Decontamination/Disinfection .....	54
7.3.1	Disinfection Solutions.....	54
7.3.2	Disinfection Procedure.....	55
7.3.3	Safety Certificate .....	55
7.4	Disposal.....	56
7.4.1	Disposal of Packaging Material.....	56
7.4.2	Disposal of Operating Material.....	56

7.4.3	Disposal of the Instrument.....	57
<b>8</b>	<b>Operation of SPARK with SparkControl Software.....</b>	<b>59</b>
8.1	Area of Application.....	59
8.2	System Requirements.....	59
8.3	Software Installation.....	61
8.3.1	Uninstall/Repair Installation.....	61
8.4	Starting the SparkControl.....	61
8.4.1	Connecting Instruments.....	61
8.5	Method Editor.....	62
8.5.1	Structure.....	62
8.5.2	Control Bar.....	63
8.5.3	Workflow Pane.....	63
8.5.4	Menu Bar.....	63
8.5.5	Toolbar.....	65
8.5.6	Instrument.....	65
8.5.7	Select Component.....	65
8.5.8	Select App.....	65
8.6	Control Bar.....	66
8.6.1	Plate.....	67
8.6.2	Detection.....	72
8.6.3	Action.....	72
8.6.4	Kinetic.....	75
8.7	Workflow Pane.....	76
8.7.1	Hierarchy of Strips.....	76
8.7.2	Info Pane.....	78
8.7.3	Measurement Types.....	78
8.7.4	Multiple Reads per Well.....	81
8.8	Dashboard.....	83
8.8.1	Structure.....	83
8.8.2	Software Navigation.....	85
8.8.3	The Dashboard.....	86
8.8.4	Instrument Control.....	87
8.8.5	Starting a Method.....	88
8.8.6	Measurement Progress.....	90
8.8.7	Data Display.....	90
8.8.8	Scans.....	92
8.8.9	Images.....	93
8.9	Starting a Method.....	94
8.9.1	Method Editor.....	94
8.9.2	Dashboard.....	94
8.9.3	Onboard-Start.....	94
8.10	Measurement Results.....	94
8.11	Method File Explorer.....	94
8.12	SparkControl Settings.....	95
8.12.1	Structure.....	95
8.12.2	Instrument.....	95
8.12.3	Data Handling.....	96
8.12.4	Software.....	98
8.12.5	Plate Geometry Editor.....	98
8.12.6	Images.....	100
8.13	Screencasts.....	100
<b>9</b>	<b>Luminescence.....</b>	<b>101</b>
9.1	Basic Principles.....	101
9.2	Measurement Techniques.....	101
9.2.1	Glow Luminescence.....	101
9.2.2	Flash Luminescence.....	101

9.2.3	Multicolor Luminescence .....	101
9.2.4	Luminescence Scan.....	102
9.3	Standard Luminescence Module .....	102
9.3.1	Luminescence Optics.....	102
9.3.2	Standard Luminescence Detection .....	103
9.4	Enhanced Luminescence Module.....	103
9.4.1	Luminescence Filters.....	103
9.4.2	Enhanced Luminescence Optics .....	104
9.4.3	Luminescence Detection.....	105
9.5	Defining Luminescence Measurements.....	105
9.5.1	Luminescence Strip .....	106
9.5.2	Multicolor Luminescence Strip .....	108
9.5.3	Luminescence Scan Strip .....	110
9.5.4	Corrected Spectra.....	111
9.5.5	Measurement Mode.....	111
9.6	Optimizing Luminescence Measurements.....	111
9.6.1	Integration Time.....	111
9.6.2	Light Attenuation.....	111
9.7	Luminescence Specifications.....	112
9.7.1	General Specifications.....	112
9.7.2	Performance Specifications .....	112
9.8	Quality Control of the Luminescence Module .....	113
9.8.1	Periodic Quality Control Tests .....	113
9.8.2	Detection Limit ATP 384-Well Plate .....	113
9.8.3	Detection Limit ATP 1536-Well Plate.....	114
<b>10</b>	<b>Alpha Technology .....</b>	<b>117</b>
10.1	Basic Principles .....	117
10.2	Alpha Module.....	117
10.2.1	Filter.....	117
10.2.2	Optics.....	117
10.2.3	Laser.....	118
10.2.4	Detection.....	118
10.2.5	Temperature Correction.....	119
10.3	Defining Alpha Measurements.....	119
10.3.1	Alpha Technology .....	119
10.3.2	Measurement Mode.....	120
10.4	Optimizing Alpha Technology based Measurements.....	121
10.4.1	Integration Time.....	121
10.4.2	Excitation Time .....	121
10.5	Alpha Specifications .....	121
10.5.1	General and Performance Specifications.....	121
10.6	Quality Control.....	122
10.6.1	Periodic Quality Control Tests .....	122
10.6.2	Detection Limit AlphaScreen Omnibeads 384-Well Plate .....	122
10.6.3	Uniformity AlphaScreen Omnibeads 384-Well Plate.....	124
<b>11</b>	<b>Absorbance.....</b>	<b>127</b>
11.1	Basic Principles .....	127
11.2	Absorbance Measurement Techniques .....	127
11.2.1	Absorbance Scan .....	127
11.3	Absorbance Module.....	127
11.3.1	Absorbance Optics .....	128
11.4	Cuvette Module.....	129
11.4.1	Cuvette Optics .....	129
11.5	Measurement Equipment.....	130
11.5.1	Microplates .....	130
11.5.2	Cuvette Adapter.....	130



11.5.3	Cuvette Port .....	131
11.6	Defining Absorbance Measurements .....	133
11.6.1	Absorbance Strip .....	133
11.6.2	Absorbance Scan Strip .....	134
11.7	Absorbance Measurement Modes .....	135
11.7.1	Optimizing Absorbance Measurements .....	135
11.8	NanoQuant Application .....	135
11.8.1	NanoQuant Plate .....	135
11.9	Absorbance Specifications .....	136
11.9.1	General Specifications .....	136
11.9.2	Performance Specifications in Microplates .....	137
11.9.3	Measurement Times .....	137
11.9.4	Performance Specifications in Cuvettes (Cuvette port) .....	137
11.9.5	Specifications for the NanoQuant Plate .....	138
11.10	Quality Control of the Absorbance Module .....	138
11.10.1	Periodic Quality Control Tests .....	138
11.10.2	Uniformity 96-Well Plate .....	139
11.10.3	Quality Control of NanoQuant Plate .....	140
<b>12</b>	<b>Fluorescence .....</b>	<b>141</b>
12.1	General Description .....	141
12.2	Fluorescence Intensity (FI) .....	141
12.3	Fluorescence Resonance Energy Transfer (FRET) .....	141
12.4	Time-Resolved Fluorescence (TRF) .....	141
12.5	Fluorescence Polarization (FP) .....	142
12.6	Fluorescence Intensity Module .....	142
12.6.1	How a Monochromator Works .....	143
12.7	Fluorescence Top Module .....	144
12.7.1	Fluorescence Top Module Optics .....	144
12.7.2	Fluorescence Top Module Options .....	145
12.8	Fluorescence Bottom Module .....	146
12.8.1	Fluorescence Bottom Module Optics .....	146
12.8.2	Fluorescence Bottom Module Options .....	146
12.9	Fluorescence Functions .....	147
12.9.1	Z-Positioning .....	147
12.9.2	Fluorescence Detection .....	147
12.9.3	Fluorescence Scans .....	147
12.9.4	Spectral Intensity Calibration .....	147
12.10	Measurement Equipment .....	147
12.10.1	Filters .....	147
12.10.2	Filter Slides .....	148
12.10.3	Installing and Removing Filters .....	149
12.10.4	Inserting Filter Slides .....	150
12.10.5	Defining the Filters .....	150
12.10.6	Mirror Slides .....	152
12.10.7	Installing the Custom Dichroic Mirror .....	153
12.10.8	Defining the Custom Dichroic Mirror .....	154
12.11	Defining Fluorescence Measurements .....	154
12.11.1	Fluorescence Intensity Strip .....	155
12.11.2	Time-Resolved Fluorescence Intensity Strip .....	158
12.11.3	Fluorescence Intensity Scan Strip .....	161
12.11.4	Measurement Mode .....	162
12.12	Fluorescence Polarization Module .....	163
12.12.1	Fluorescence Polarization Optics .....	163
12.12.2	Fluorescence Polarization Detection .....	163
12.12.3	Defining Fluorescence Polarization Measurements .....	164
12.13	Optimizing Fluorescence and Fluorescence Polarization Measurements .....	166

12.14	Fluorescence Specifications .....	169
12.14.1	General Specifications of Fluorescence Intensity (Standard and Enhanced module)...	169
12.14.2	Performance Specifications of Fluorescence Intensity.....	170
12.14.3	General Specifications of Fluorescence Polarization (Standard and Enhanced Polarization module) .....	173
12.14.4	Performance Specifications of Fluorescence Polarization .....	173
12.14.5	Fastest Measuring Time .....	174
12.15	Quality Control of the Fluorescence Module .....	174
12.15.1	Periodic Quality Control Tests .....	174
12.15.2	Detection Limit Top/Bottom 96-Well Plate .....	175
12.15.3	Uniformity Top/Bottom 96-Well Plate.....	176
12.15.4	Detection Limit Top/Bottom 384-Well Plate .....	177
12.15.5	Uniformity Top/Bottom 384-Well Plate.....	179
12.15.6	Detection Limit Top/Bottom 1536-Well Plate .....	180
12.15.7	Uniformity Top/Bottom 1536-Well Plate.....	182
12.15.8	Detection Limit TRF 96-Well Plate.....	183
12.15.9	Detection Limit TRF 384-Well Plate.....	184
12.15.10	Detection Limit TRF 1536-Well Plate.....	186
12.15.11	Fluorescence Polarization Precision 96-Well Plate.....	187
12.15.12	Fluorescence Polarization Precision 384-Well Plate.....	189
12.15.13	Fluorescence Polarization Precision 1536-Well Plate.....	191
<b>13</b>	<b>Cell Module.....</b>	<b>193</b>
13.1	Measurement Techniques .....	193
13.1.1	Cell Counting/Cell Viability.....	193
13.1.2	Cell Confluence .....	193
13.2	Bright-field Imaging.....	193
13.2.1	Optics.....	193
13.2.2	Detection.....	194
13.3	Measurements Equipment.....	194
13.3.1	Cell Chips .....	194
13.3.2	Adapter for Cell Chips.....	195
13.3.3	Maintenance and Cleaning of the Cell Chip Adapter .....	195
13.4	Defining Cell Counting & Confluence Measurements .....	196
13.4.1	Cell Counting Strip.....	196
13.4.2	Cell Confluence Strip .....	197
13.4.3	Measurement Mode.....	197
13.5	Cell Counting Application.....	198
13.6	Optimizing Cell Counting Measurements.....	198
13.6.1	Increase Number of Images.....	198
13.7	Optimizing Cell Confluence Measurements.....	198
13.7.1	Use the Well Border Detection.....	198
13.8	Cell Module Specifications.....	199
13.8.1	General Specifications .....	199
13.8.2	Specifications Cell Counting/Viability.....	199
13.8.3	Measurement Time .....	199
13.9	Quality Control of Cell Counting.....	200
13.9.1	Periodic Quality Control Tests .....	200
13.9.2	Cell Counting Accuracy.....	201
<b>14</b>	<b>Injectors.....</b>	<b>203</b>
14.1	Injector Carrier .....	204
14.1.1	Injector Dummy.....	205
14.1.2	Storage Bottles and Bottle Holders.....	205
14.2	Priming and Rinsing.....	207
14.2.1	Priming.....	207
14.2.2	Reagent Backflush.....	208
14.3	Injector Cleaning and Maintenance .....	211

14.3.1	Syringe Replacement.....	211
14.4	Injector: Reagent Compatibility .....	212
14.5	Performing Measurements with Injectors.....	213
14.5.1	Injector Strip.....	213
14.5.2	Injector Strip in Measurement Flow.....	213
14.5.3	Z-Drive Injector Port.....	214
14.5.4	Optimizing Measurements with Injection.....	214
14.6	Heater and Magnetic Stirrer.....	214
14.6.1	Installing the Heater/Stirrer.....	215
14.6.2	Temperature Regulation .....	216
14.6.3	Setting the Stirring Speed .....	216
14.6.4	Laboratory Flask and Magnetic Stir Bar.....	216
14.7	Injector Specifications.....	216
14.7.1	Technical Specifications for the Injector.....	216
14.7.2	Performance Specifications for the Injector.....	217
14.7.3	Specifications for the Heater / Stirrer .....	217
14.8	Quality Control of the Injector Module.....	217
14.8.1	Periodic Quality Control Tests.....	217
14.8.2	Injector Accuracy.....	217
<b>15</b>	<b>Environmental Control.....</b>	<b>219</b>
15.1	Heating Module.....	219
15.1.1	Manual Temperature Control .....	219
15.1.2	Temperature Control via Method.....	220
15.2	Cooling Module (Te-Cool).....	221
15.2.1	Connecting the Cooling module .....	221
15.2.2	Cooling Circuit Connection and Filling .....	222
15.2.3	Starting the Water Cooling Device for the First Time .....	225
15.2.4	Operating the Cooling module.....	225
15.2.5	Cooling Control Software Settings .....	226
15.2.6	Alarm Function/Troubleshooting .....	226
15.2.7	Maintenance.....	227
15.3	Gas Control.....	227
15.3.1	Gas Safety .....	227
15.3.2	Gas Connection .....	228
15.3.3	CO <sub>2</sub> and N <sub>2</sub> Gas Cylinders (Not Supplied).....	230
15.3.4	Gas Control Software Settings.....	231
15.3.5	Manual Gas Control .....	232
15.3.6	Gas Control via Method .....	232
15.3.7	Acoustic Alarm .....	234
15.4	Humidity Control.....	235
15.4.1	Humidity Cassette.....	235
15.4.2	Handling Procedure .....	236
15.4.3	Software Settings.....	237
15.5	Environmental Control Specifications.....	238
15.5.1	Heating.....	238
15.5.2	Cooling.....	238
15.5.3	Gas Control.....	238
15.5.4	Humidity Control.....	238
<b>16</b>	<b>NanoQuant App.....</b>	<b>239</b>
16.1	Nucleic Acid Quantitation App.....	239
16.1.1	Applying Samples .....	240
16.1.2	Starting the Nucleic Acid Quantitation App.....	240
16.1.3	Validation Criteria for Blanking Results .....	243
16.1.4	Repeat Blanking.....	243
16.1.5	Start Measurement.....	243
16.2	Labeling Efficiency App.....	246

16.3	Calculations .....	247
16.3.1	Calculation of Nucleic Acid Concentration .....	247
16.3.2	Blanks .....	247
16.3.3	Samples .....	248
16.3.4	Labeled Samples .....	248
16.4	NanoQuant Maintenance .....	249
16.4.1	Cleaning Procedure with Ultrasonic Bath .....	249
16.4.2	Cleaning Procedure with Kimwipe .....	249
<b>17</b>	<b>Cell Counting in Cell Chips.....</b>	<b>251</b>
17.1	Sample Preparation .....	251
17.2	Cell Viability .....	253
17.2.1	Starting the Cell Viability App.....	253
17.2.2	Sample Selection .....	253
17.2.3	Measurement Results .....	255
17.2.4	Cell Histogram .....	258
17.2.5	Duplicates .....	258
17.3	Cell Counting App.....	258
<b>18</b>	<b>Cuvette App .....</b>	<b>259</b>
18.1	Prepare Instrument and Blanking .....	259
18.2	Measurement.....	260
<b>19</b>	<b>Troubleshooting .....</b>	<b>263</b>
19.1	SparkControl Errors and Warnings .....	263
	<b>Index .....</b>	<b>269</b>
	<b>Tecan Customer Support .....</b>	<b>271</b>

# 1 Safety

## 1.1 Introduction

- Always follow basic safety precautions when using this product to reduce the risk of injury, fire, or electrical shock.
- Read and understand all information in the Instructions for Use. Failure to read, understand, and follow the instructions in this document may result in damage to the product, injury to operating personnel or poor instrument performance.
- Observe all WARNING and CAUTION statements in this document.
- Never open the instrument while it is plugged into a power source.
- Never force a microplate into the instrument.
- Observe proper laboratory safety precautions, such as wearing protective clothing (gloves, lab coat, safety glasses, etc.) and using approved laboratory safety procedures.



**CAUTION:** To ensure the optimal operation of the SPARK, an annual maintenance procedure must be performed by a Tecan service engineer.



**WARNING:** If the instructions given in these Instructions for Use are not followed properly, the safety of the instrument cannot be guaranteed because the procedures might not be performed correctly and the instrument could become damaged.

It is assumed that the instrument operators, because of their vocational experience, are familiar with the necessary safety precautions for handling chemicals and biohazardous substances.

Adhere to the following laws and guidelines:

- National industrial protection law
- Accident prevention regulations
- Safety data sheets of the reagent manufacturers



**WARNING:** Depending on the applications, parts of the instrument may come in contact with biohazardous/infectious material. Make sure that only qualified personnel operate the instrument. In case of service or when relocating or disposing of the instrument, always disinfect the instrument according to the instructions given in this manual.



**WARNING:** Do not open the instrument! Only Tecan authorized service technicians are allowed to open the instrument. Removing or breaking the warranty seal voids the warranty.



## 2 General Description

### 2.1 Instrument

The SPARK is a multifunctional microplate reader platform and is robotic compatible.

### 2.2 Intended Use (Hardware and Software)

The SPARK multimode microplate reader with a modular design is intended for use in research laboratories. When equipped with all modules, the instrument is intended for the measurement and measurement data analysis of absorbance, fluorescence, time resolved fluorescence, fluorescence polarization and luminescence of biological and non-biological samples. For cell based assays, the instrument is also intended for the determination of cell number. Additionally, the reader is suited for both endpoint and kinetic measurements with either single or multi-label measurements. The SPARK is equipped with the SparkControl software for reader control and data reduction.

The user must evaluate this instrument and any associated data reduction packages with their specific assays to ensure specified performance characteristics of the assay are met. The performance characteristics of the instrument have not been validated for specific assays.

The SPARK multimode reader is for research use only.



**CAUTION:** A system validation by the operating authority is required. It is the responsibility of any operating authority to ensure that the SPARK has been validated for every specific assay used on the instrument.

## 2.3 User Profile

### 2.3.1 Professional User – Administrator Level

The administrator is a person who has suitable technical training and corresponding skills and experiences. If the product is used as intended, the person is able to recognize and avoid dangers.

The administrator has extensive skills and is able to instruct the end user or the routine user in assay protocols in connection with a Tecan product within the bounds of the intended use.

Computer application skills and good English skills are required.

### 2.3.2 End User or Routine User

The end user or routine user is a person who has suitable technical training and corresponding skills and experiences. If the product is used as intended, the person is able to recognize and avoid dangers.

Computer application skills and good language skills for the respective national language at the installation site and English are required.

### 2.3.3 Service Technician

The service technician is a person who has suitable technical training and corresponding skills and experiences. If the product needs to be serviced or maintained, the person is able to recognize and avoid dangers.

Computer application skills and good English skills are required.



**NOTE:** Training dates, their duration and frequency are available at your customer support. Address and phone number can be found in the web: <http://www.tecan.com/customersupport>

## 2.4 Multifunctionality

The fully equipped instrument (Spark 10M or Spark 20M) is able to perform the following measurement techniques (for detailed information, see chapter 5 Spark Platform).

Absorbance	Fluorescence Scan
Absorbance Scan	Fluorescence Polarization
Absorbance Cuvette	Luminescence (Glow Type, Flash Type and Multicolor)
Absorbance Scan Cuvette	Luminescence Scan
Fluorescence Intensity Top (FRET)	Alpha Technology
Fluorescence Intensity Bottom	Cell Counting
Time Resolved Fluorescence (TRF, TR- FRET)	Cell Confluence

The instrument can be equipped with up to two injectors and a heater/stirrer. Special functionalities (such as cell counting, gas supply and lid lifting, temperature control - heating and cooling - and humidity control) support cell based studies in particular.



## 2.5 Microplate Requirements

Any common microplate ranging from 1 to 384-/1536-well formats compliant to the following ANSI/SBS standards can be measured with any of the above measurement techniques.

- ANSI/SBS 1-2004 (footprint dimensions)
- ANSI/SBS 2-2004 (height dimensions)
- ANSI/SBS 3-2004 (bottom outside flange dimensions)
- ANSI/SBS 4-2004 (well positions)

The Spark 10M supports microplates up to 384 wells. The Spark 20M supports microplates up to 1536 wells.

The supported range of the plate heights is 11 mm (without lid) up to 24.5 mm (including lid). For bottom measurements, the elevation of the bottom of the well relative to the supporting plate rim must not be larger than 5.5 mm.

In addition to the above mentioned microplate formats, cuvettes in an adapter, the Tecan NanoQuant Plate, the Tecan MultiCheck Plate and the Tecan Adapter for Cell Chips can be used with limitations for selected measurement techniques.



**CAUTION:** Tecan Austria GmbH has taken great care when creating the Plate Definition Files (.pdfx) that are delivered with the instrument.

Tecan Austria has taken every precaution to ensure that plate heights and well depths are correct according to the defined plate type. These parameters are used to determine the minimum distance between the top of the plate and the ceiling of the measurement chamber. Additionally, Tecan Austria adds a very small safety gap to prevent any damage that may occur to the measurement chamber as a result of small changes in plate height. This has no effect on the performance of the instrument.

The user **MUST** ensure that the plate definition file selected corresponds to the actual plate being used. The safety gap cannot be calculated by the instrument if the plate used does not match the pdf selected.



**CAUTION:** Microplate types with less than 6 wells can be used with dry or solid substances only. Sloshing of liquids can result in instrument damages.

## 2.6 Onboard Control Buttons

The SPARK has onboard control buttons to simplify some common tasks.

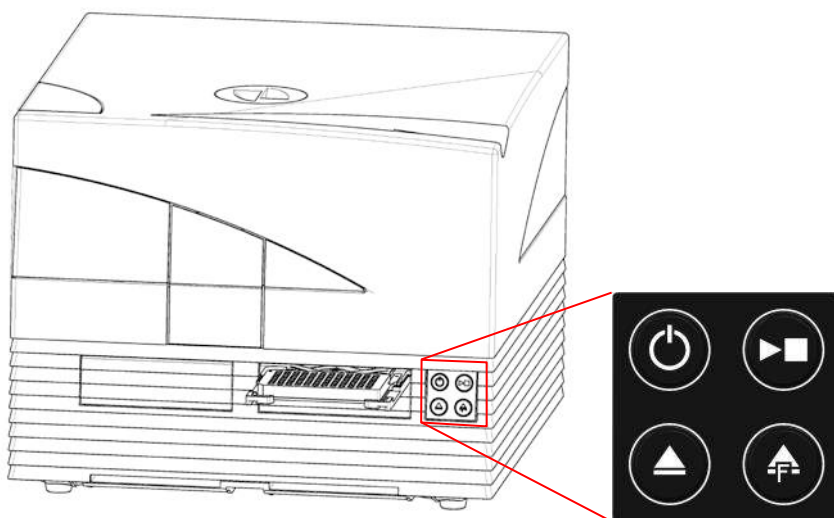

An **On/Off** button is available on the front to easily switch the instrument on and off.



The **Onboard-Start** button is used to start favorite SparkControl Methods directly from the instrument. It can also be used to stop a measurement, confirm user-defined user interventions, and to continue kinetic measurements already paused via the software.



The **Retract/Eject** button allows microplates to be inserted or removed from the instrument without software activation.



The **Eject Filter** button is used to move out the filter slides. The filter slides are moved in automatically at insertion.

## 2.7 Instrument LEDs

The SPARK is equipped with multi-color LEDs to optically signal the operation/activity state of the instrument. The table below gives an overview of possible signals that define which functionalities (Onboard Control buttons) are available at which instrument state.

Led Status	Instrument State	Onboard Control Buttons		
		Retract/ Eject	Eject Filter	Onboard- Start
-	OFF	O	O	O
-	STANDBY (5V)	O	O	O
BLUE	IDLE (not connected to SparkControl)	X	X	X
MAGENTA	IDLE (connected to SparkControl)	X	X	X
GREEN	RUN	O	O	X
RED BLINKING	ERROR	O	O	O
YELLOW BLINKING	USER INTERACTION	X	O	X
GREEN BLINKING	PAUSE	X	O	X
5x CYAN BLINKING	ACTION NOT POSSIBLE	O	O	O

Table of LED states and functionalities.

O = function not available.

X = function available.

## 2.8 Rear View

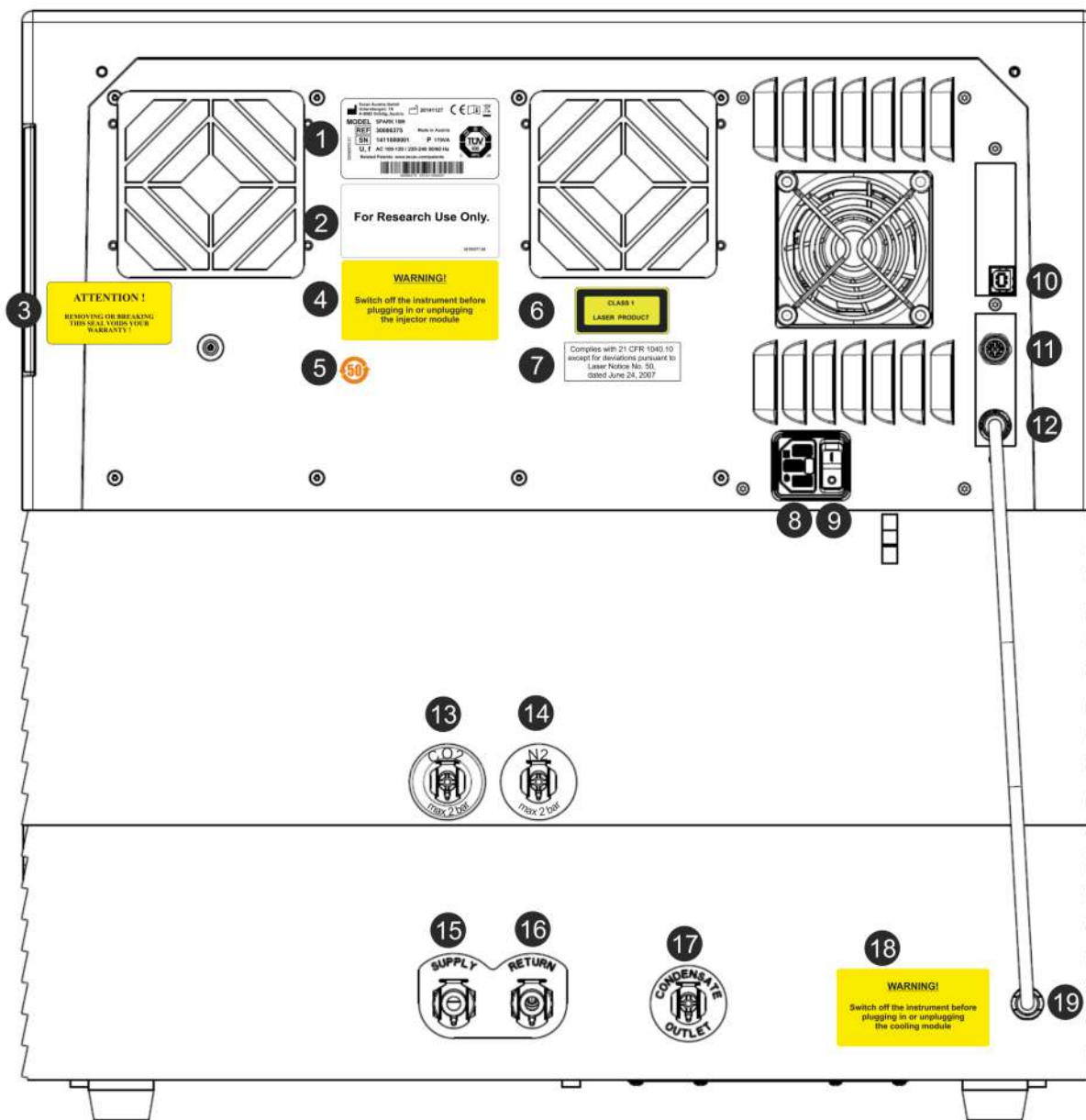

Figure 1: Rear view of the instrument



**NOTE:** This figure is only an example. The labels on the instrument depend on options installed and destination country.

1	Name Plate (example)
2	Label: For Research Use Only.
3	Warranty Label: ATTENTION ! REMOVING OR BREAKING THIS SEAL VOIDS YOUR WARRANTY! (also on bottom of instrument)
4	Label: WARNING! Switch off the instrument before plugging in or unplugging the injector module
5	Label: RoHS Orange Logo
6	Label: Class 1 Laser Product
7	Label: Complies with 21 CFR 1040.10 except for deviations pursuant to Laser Notice No. 50, dated June 24, 2007
8	Main Power Socket
9	Main Power Switch
10	Injector connection
11	USB connection
12	CAN Cable to Cooling Module
13	CO <sub>2</sub> connection (max 2 bar)
14	N <sub>2</sub> connection (max 2 bar)
15	Supply: liquid cooling
16	Return: liquid cooling
17	Condensate outlet
18	Label: WARNING! Switch off the instrument before plugging in or unplugging the cooling module
19	CAN Cable to Instrument

## 2.9 Instrument Dimensions

All dimensions are given in millimeters.

### Instrument - Front View

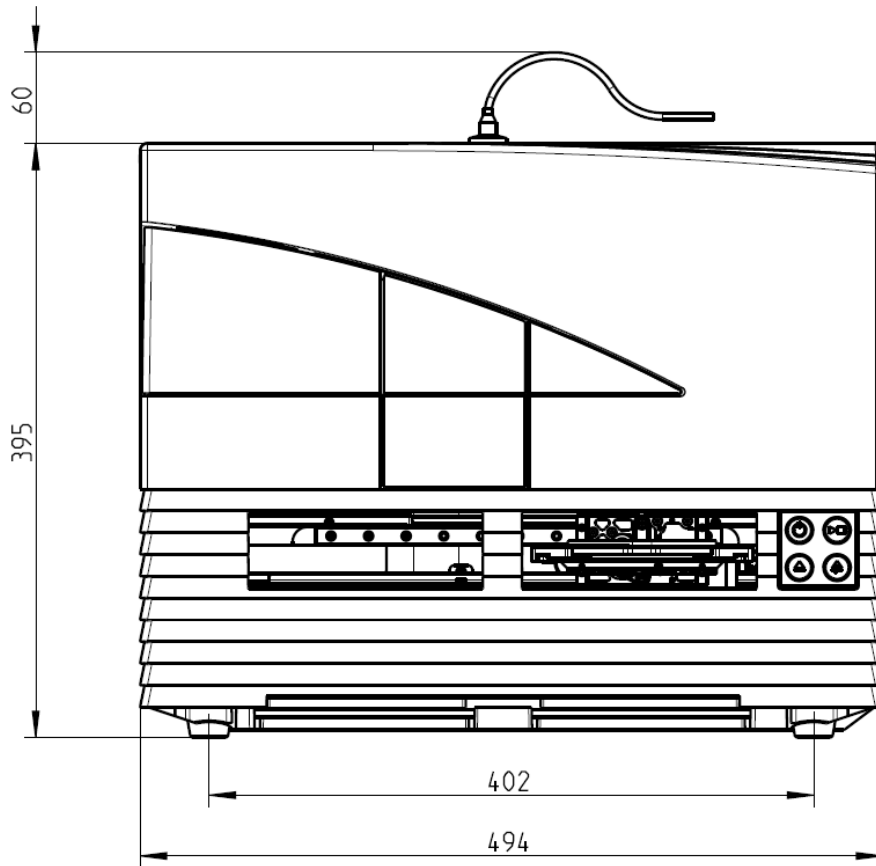

Instrument - Side View

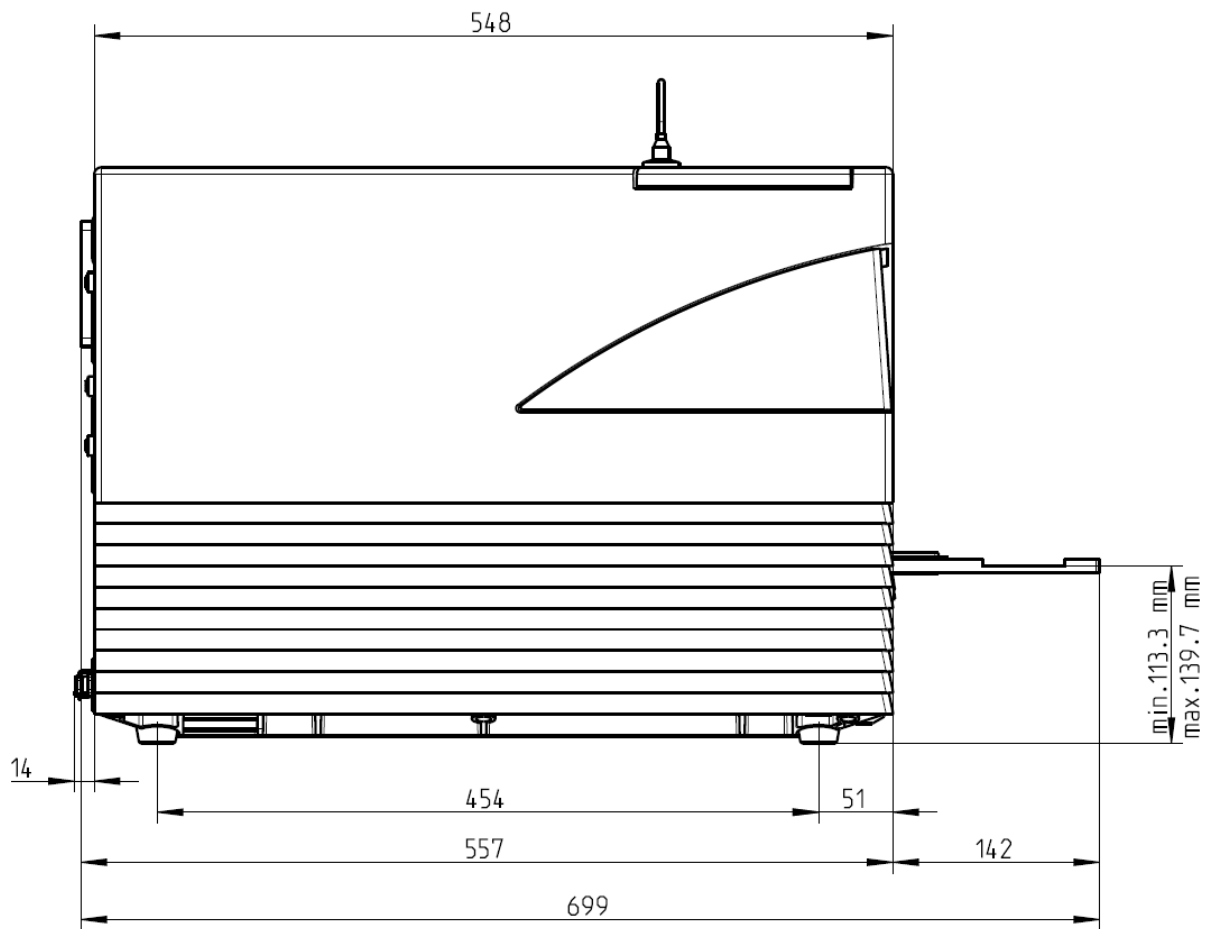

**Two Syringe Injector with Heater Stirrer - Front View**

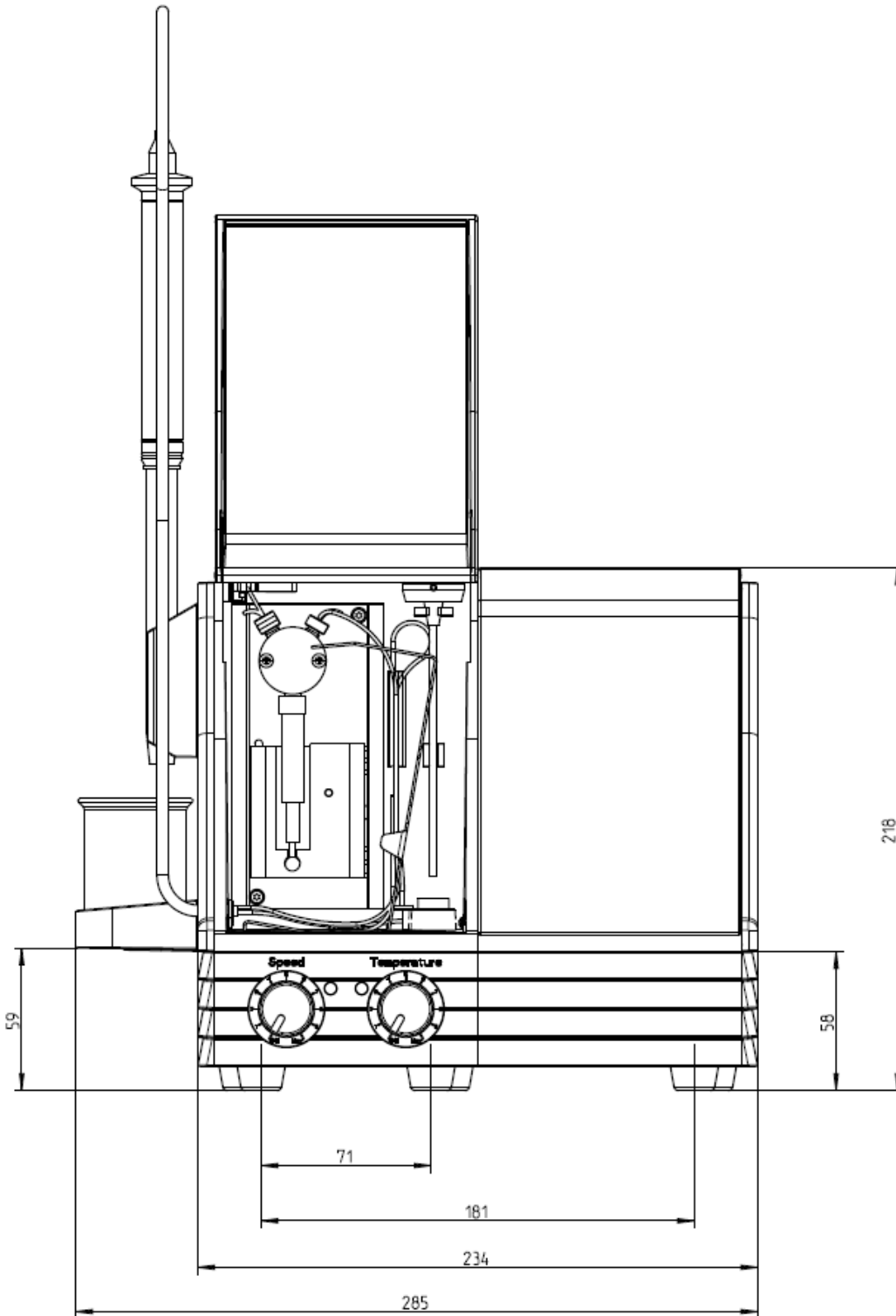



Two Syringe Injector with Heater Stirrer - Side View

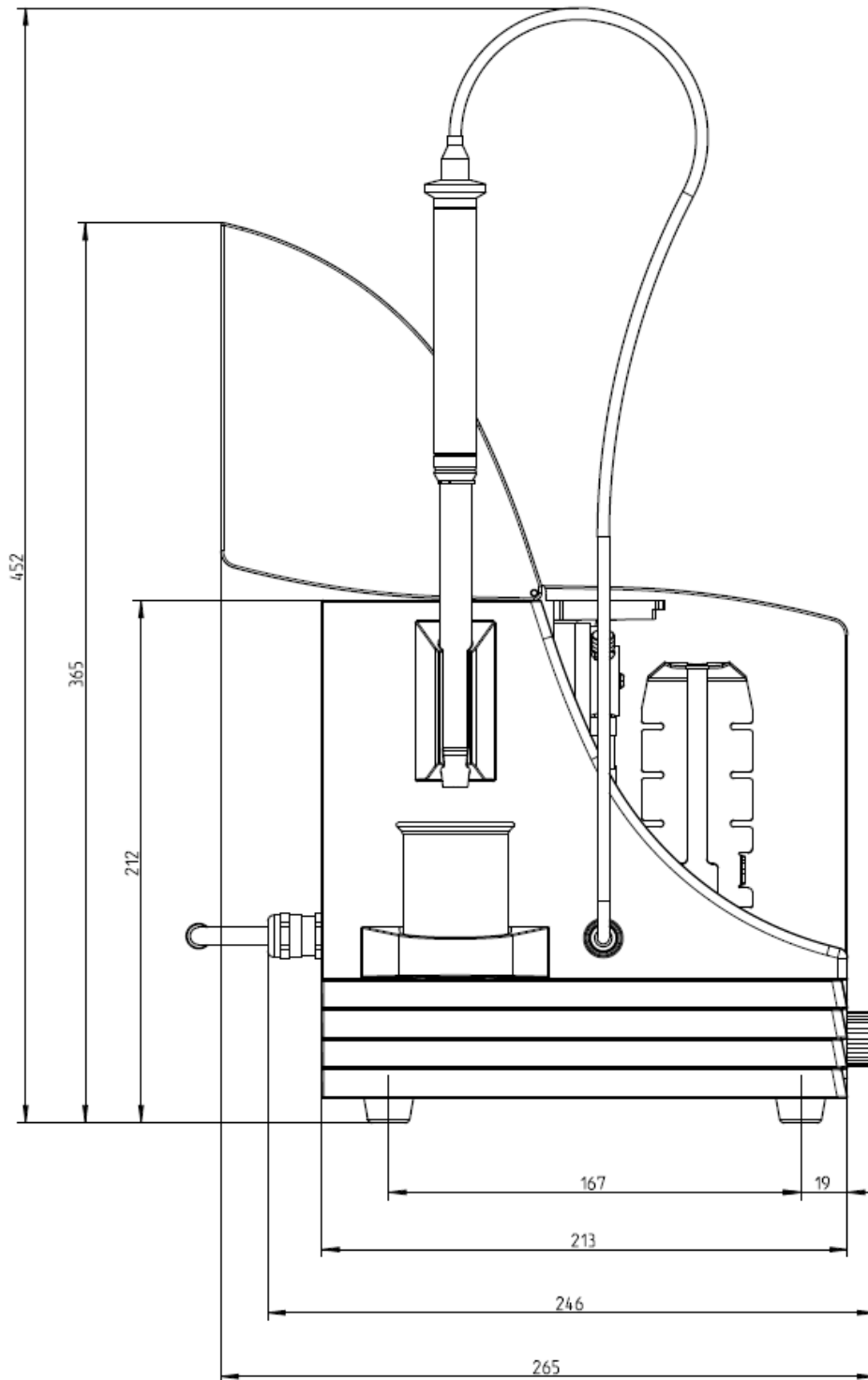

**Injector Box - Front View**

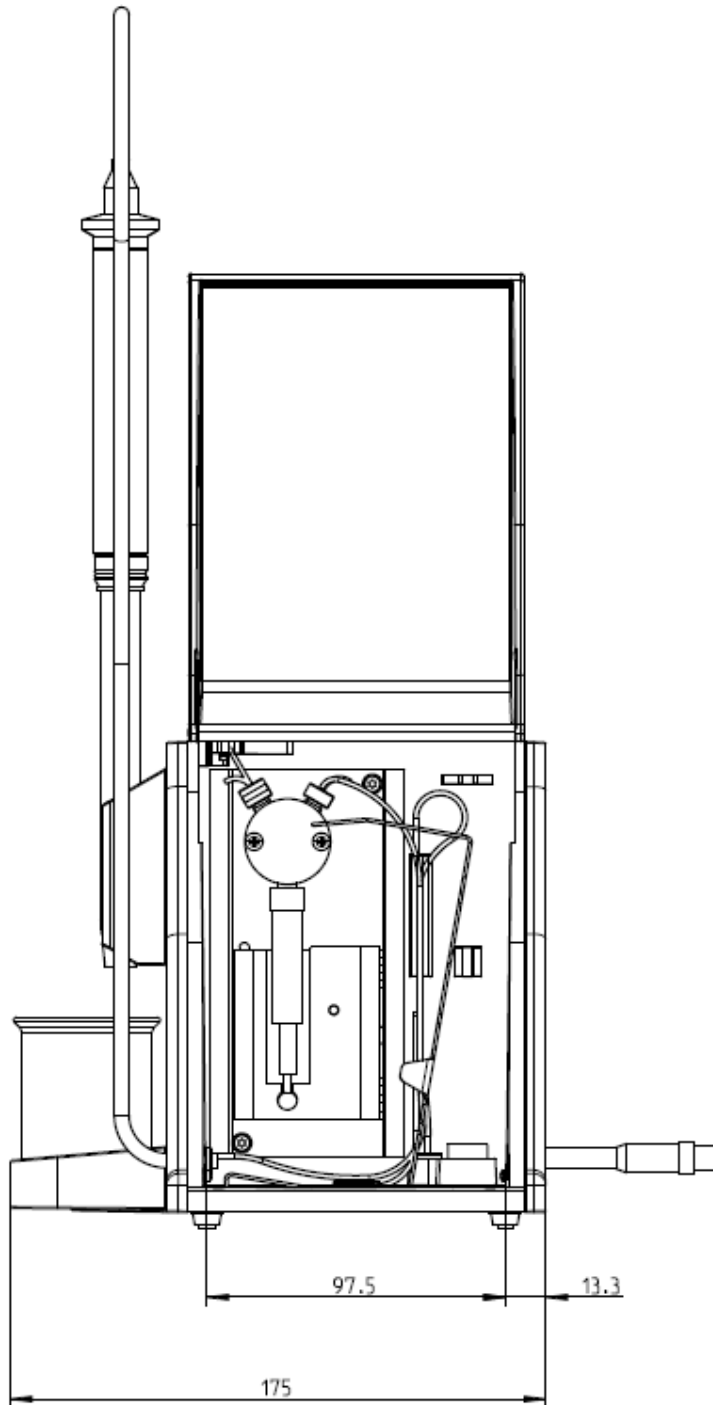

Injector Box - Side View

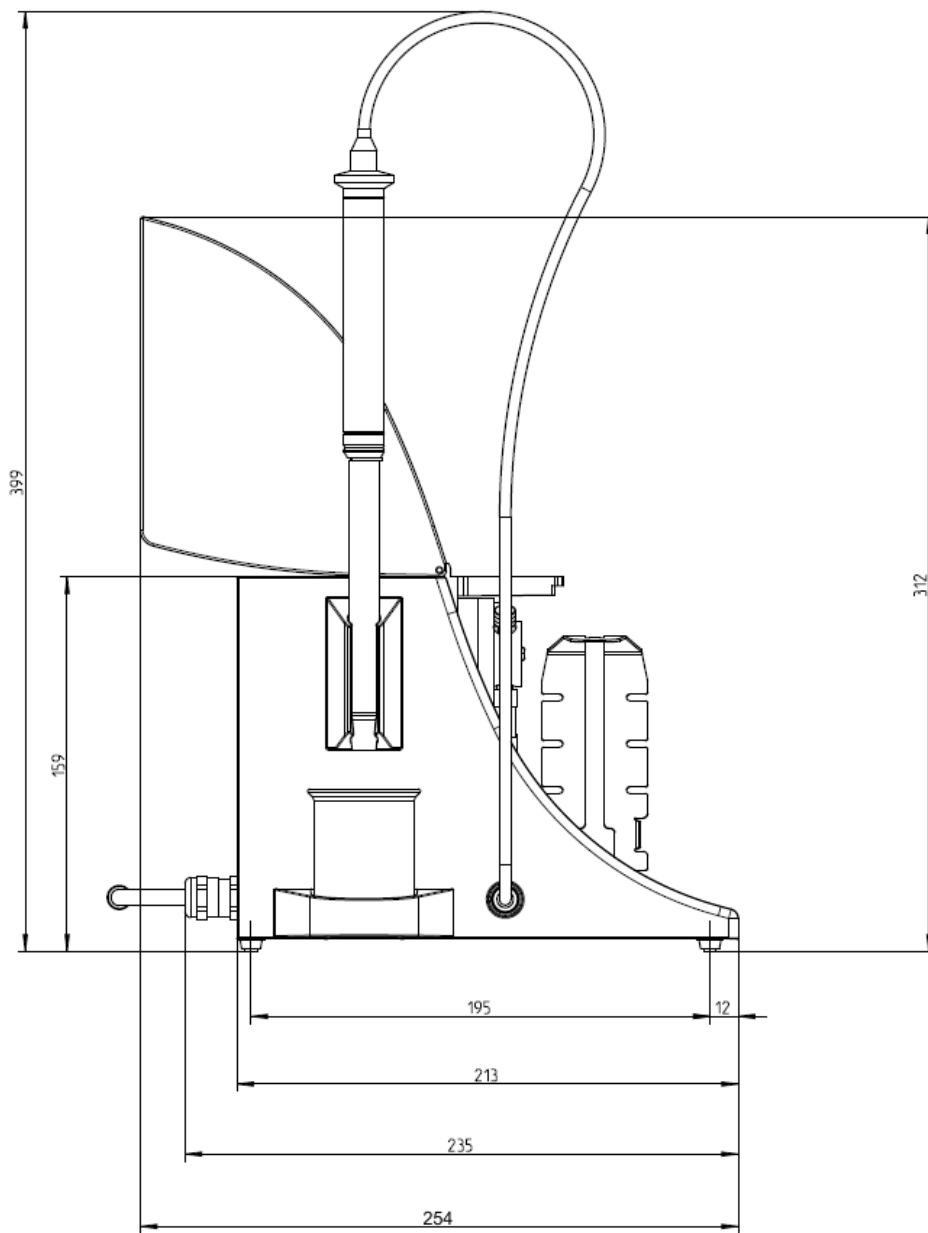

### Heater/Stirrer - Front View

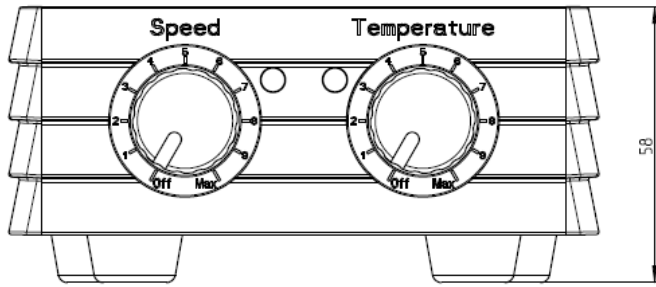

### Heater/Stirrer - Side View

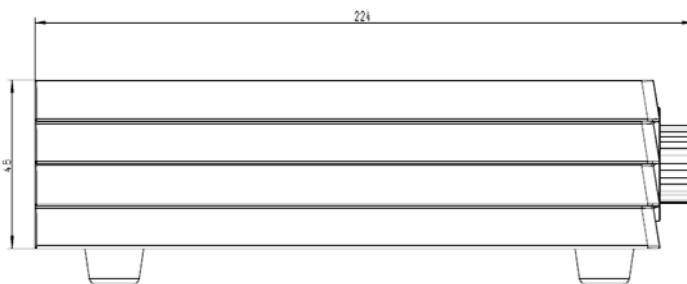

### Heater/Stirrer - Top View

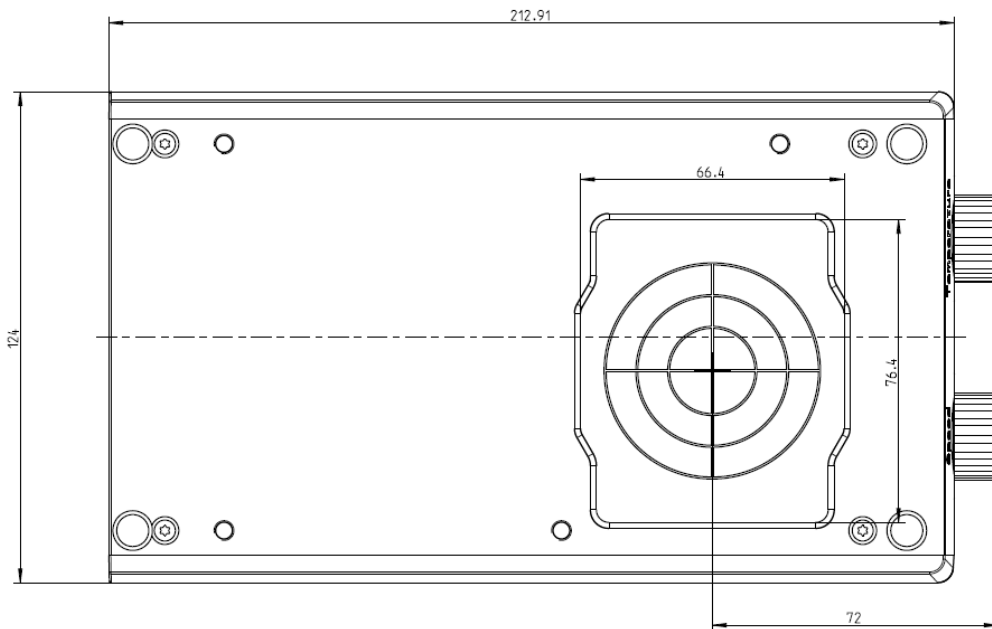

SPARK with Cooling Module - Front View

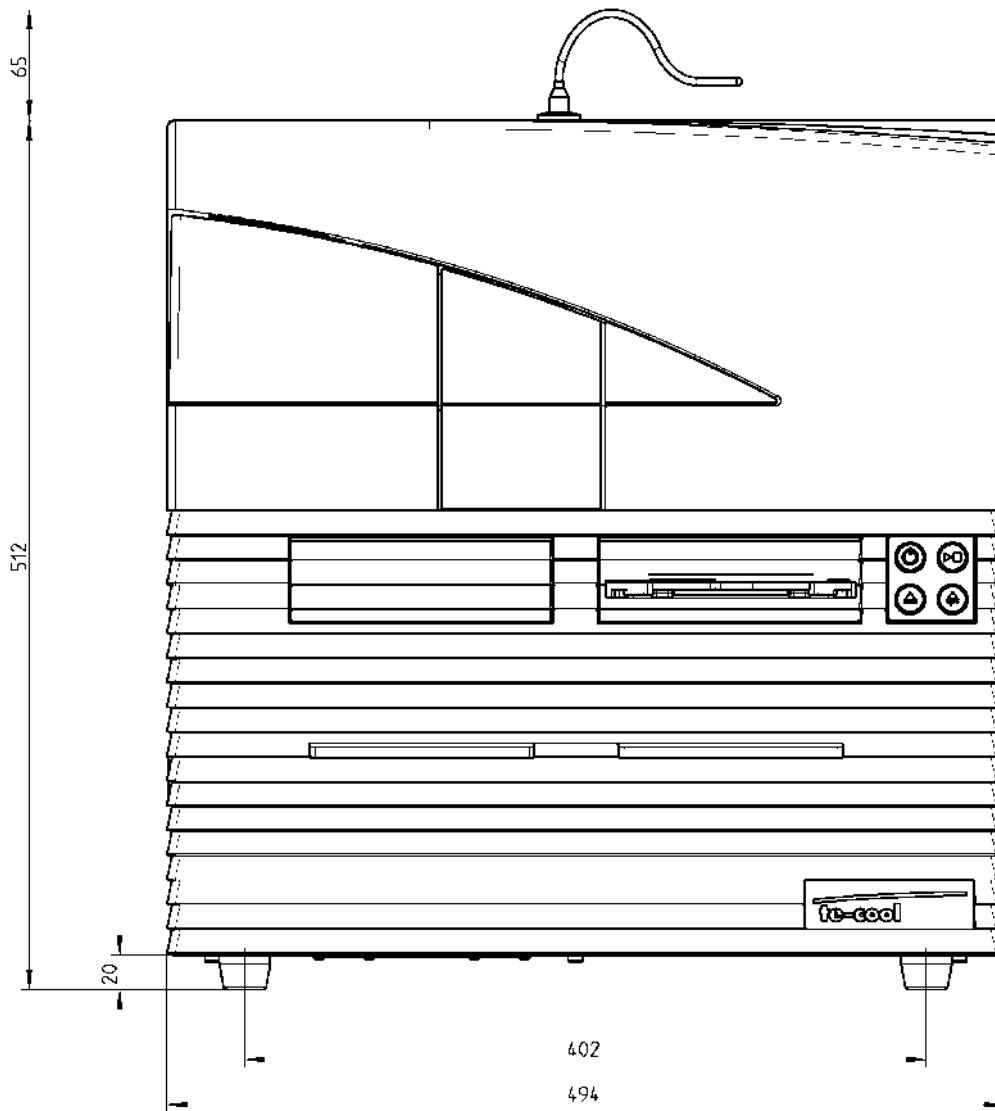

**SPARK with Cooling Module - Side View**

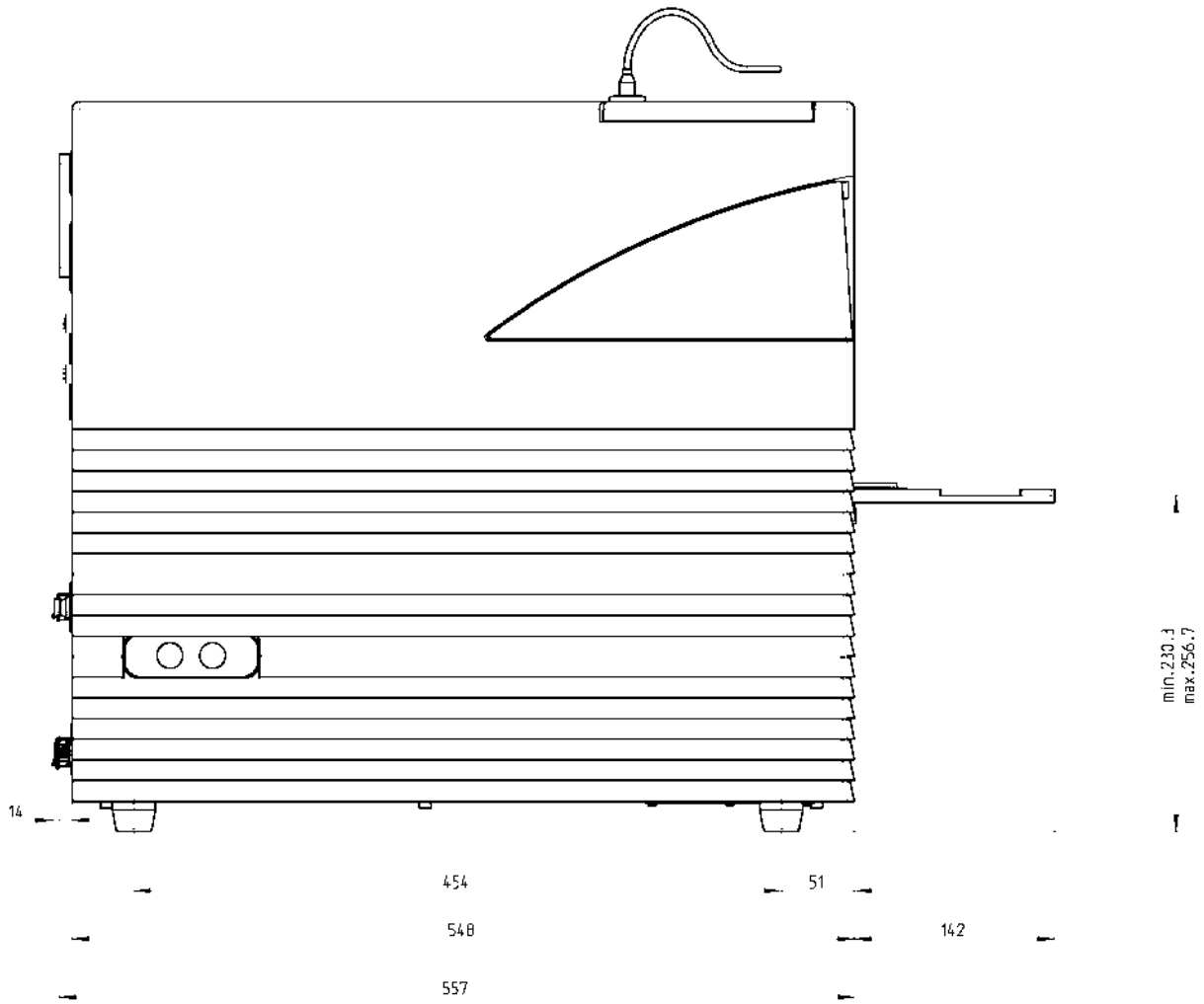

## 3 Instrument Installation

### 3.1 Installing the SPARK

When installing, moving, or connecting the instrument, follow the instructions in this document. Tecan does not accept the responsibility for injury suffered by anyone attempting these operations nor for damage incurred to the instrument.

Make sure the laboratory meets all the requirements and conditions described in this chapter

### 3.2 Installation Requirements for SPARK

#### 3.2.1 Required Working Area

Select a location to place the instrument that is flat, level, vibration free, away from direct sunlight, and free from dust, solvents and acid vapors. Allow at least 10 cm distance between the back of the instrument and the wall or any other equipment and 5 cm distance to any other equipment left and right to the instrument. See chapter 6 Instrument Specifications for further details regarding the environmental specifications.

Ensure that the plate carrier and injector carrier cannot be accidentally hit when moved out. For the installation procedure for the Injector and the Heater/Stirrer, see 14 Injectors.

For the installation procedure for the Cooling Module (Te-Cool), see chapter 15.2 Cooling Module (Te-Cool).

Ensure that the main switch and the main cable can be reached at all times and are in no way obstructed.

For information regarding outer dimensions and weight of the instrument see chapter 2.9 Instrument Dimensions.



**CAUTION:** Install the instrument in a location that is flat, level, vibration free, away from direct sunlight, and free from dust, solvents and acid vapors. Ensure that the plate carrier and injector carrier cannot be accidentally hit when moved out.



**CAUTION:** Allow at least 10 cm distance between the back of the instrument and the wall or any other equipment and 5 cm distance to any other equipment left and right to the instrument. Do not cover the instrument while it is in operation.



**CAUTION:** Do not place heavy objects on the instrument cover. The maximum load for the SPARK cover is 20 kg. However, the load must be distributed evenly across the entire surface of the cover.



**CAUTION:** Only use the supplied USB cable. The instrument has been tested with the USB cable delivered with the instrument. If another USB cable is used, Tecan Austria cannot guarantee the correct performance of the instrument.

### 3.3 Unpacking & Inspection

1. Visually inspect the container for damage before it is opened.  
Report any damage immediately.
2. Select a location according to chapter 3.2.1 Required Working Area.
3. Place the carton in an upright position and open it.
4. Lift the instrument out of the carton and place it in the selected location. Take care when lifting the instrument and ensure that it is held on both sides.
5. Visually inspect the instrument for loose, bent or broken parts. Report any damage immediately.
6. Compare the serial number on the rear panel of the instrument with the serial number on the packing list. Report any discrepancy immediately.
7. Compare the contents of the subpack to the packing list.  
Report any discrepancy immediately.
8. Save packaging materials and transport locks for further transportation purposes.



**WARNING:** The fully equipped SPARK is a precision instrument and weighs approximately 50 kg. At least two people must carefully lift the instrument from the box.



**CAUTION:** Do not overload the plate carrier. The maximum load for the plate transport is 275 g. Overloading the plate carrier can cause instrument damage which may require service.

### 3.4 Power Requirements

The instrument is auto-sensing and it is therefore unnecessary to make any changes to the voltage range. Check the voltage specifications on the rear panel of the instrument and ensure that the voltage supplied to the instrument is correct to this specification.

The voltage range is from 100-120 V and 220-240 V. If the voltage is not correct, please contact your distributor.

Connect the instrument only to an electricity supply system with a protective ground.



**CAUTION:** Do not use the instrument if the voltage setting is not correct. If the instrument is switched ON with the incorrect voltage setting it will become damaged.



## 3.5 Subpacks



**NOTE:** Always compare the contents of the subpack with the delivered packing list. Report any discrepancy immediately.

The instrument packaging includes the following items:

- Cables (USB 2.0 and main)
- Software (USB stick)
- Instruction for Use (optional)
- OOB Quality Report
- CE Declaration of Conformity
- Final Test Protocol (COC)
- RoHS Notice
- Cuvette adapter
- Transport Lock Install/Uninstall Procedure

Additional subpacks depend on the modules installed:

- Filter slide box (Fluorescence Filter/Fusion Optics Module)
- Magnetic pad (Lid Lifter)
- Hose kit (Gas Control)
- Tecan Adapter for Cell Chips box including 15 cell chips (Cell Counter)
- Injector dummy (Injector/Injector Ready)
- Roboflask box (Centering clamp with fixing screw and spare screw)
- User dichroic box (including Wrench L-Key for installation)

## 3.6 Options Packages



**NOTE:** Always compare the contents of the packaging with the delivered packing list. Report any discrepancy immediately.

The injector module packaging for one injector (basic module) includes the following items:

- Injector box
- Injector carrier
- Bottle holder
- PVC clasps
- Carbon needle
- Beaker for priming (2 x 1 ml; 1 x 50 ml)
- 125 ml bottle (light protective)
- 15 ml bottle (light protective)

The injector module packaging for the second injector (extension module) includes the following items:

- Injector box
- Bottle holder
- PVC clasps
- Carbon needle
- Beaker for priming (2 x 1 ml)
- 125 ml bottle (light protective)
- 15 ml bottle (light protective)

The Heater/Stirrer option includes the following items:

- Heater/Stirrer module
- Main cable (basic module)
- Power supply (basic module)
- Beaker glass 100 ml (basic and extension module)
- Magnetic stirring bar (basic and extension module)
- Wrench L-Key

The NanoQuant option includes the following items:

- NanoQuant storage box
- NanoQuant Plate
- Pipetting Aid
- Safety Certificate

The Humidity Cassette option includes the following items:

- Humidity Cassette (cassette plus lid)
- Magnetic pad

The Te-Cool option includes the following items:

- Water cooling device
- Tubing set
- Condensate tubing
- CAN-cable

- Stoppers
- Coolant concentrate



**CAUTION:** All items delivered with the instrument and also all spare parts or supplemental parts for the instrument are intended for use with the instrument only and are not for general use.

## 3.7 Removal of the Transport Locks

### 3.7.1 Plate Carrier Transport Lock



**CAUTION:** Remove the transport lock before operating the instrument.

The instrument is delivered with the plate carrier locked into place, so that it cannot become damaged.

Before the instrument can be used, the transport locks (foam pieces) must be removed using the following procedure:

1. Ensure that the instrument is disconnected from the main power supply.
2. Remove the tape from the filter compartment doors.



3. Remove the piece of foam from the left plate carrier compartment (see picture below).

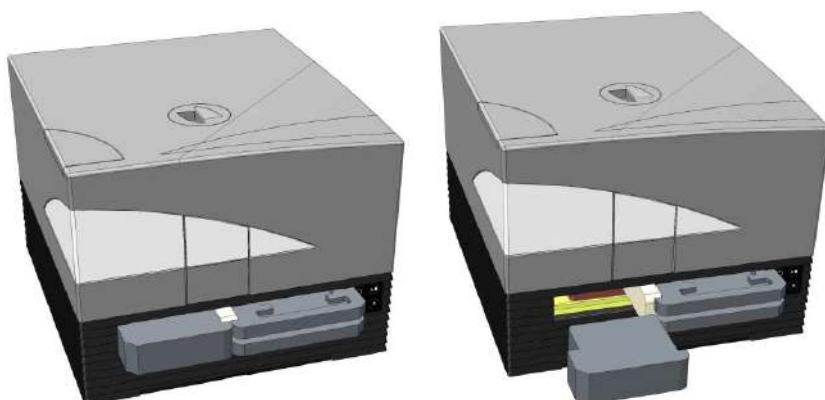

4. Move the plate carrier out manually by pulling on the pieces of foam in the right plate carrier compartment (see picture below).



5. Remove the top piece of foam first and then the bottom piece (see picture below).



6. Move the plate carrier in carefully by hand. It must be pushed in far enough so that the plate carrier compartment door can close (see picture below).

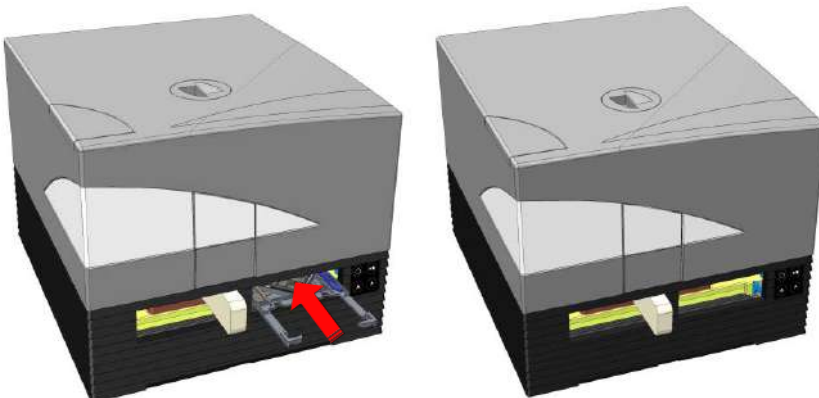

7. Rotate the remaining piece of foam 90° counter-clockwise and pull it out of the instrument (see picture below).

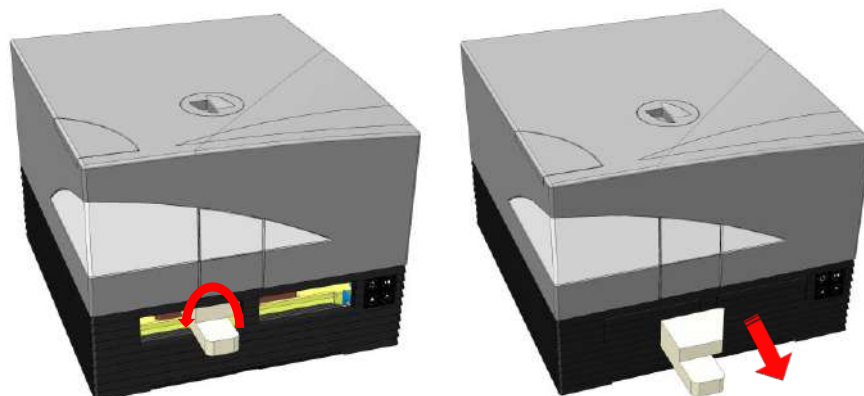

**CAUTION:** Save packaging materials and transport locks (foam pieces) for further transportation purposes. The instrument must be shipped only with the original packaging and installed transport locks.

## 3.8 Switching the Instrument On



**CAUTION:** Before the instrument is switched on for the first time, it should be left to stand for at least 3 hours, so there is no possibility of condensation causing a short circuit.

1. Ensure that the computer is switched OFF.
2. Make sure that the main power switch on the rear panel of the instrument is in the OFF position.
3. Connect the computer to the instrument only with the delivered USB interface cable.
4. Insert the power cable into the main power socket (with protective ground connection) on the rear panel of the instrument.
5. All connected devices must be approved and listed as per IEC 60950-1 Information Technology Equipment – Safety or equivalent local standards.
6. Connect the injector, if required.
7. Plug in the heater/stirrer, if required.



**CAUTION:** Switch off the instrument before plugging in or unplugging the injector module.



**CAUTION:** Switch off the instrument before plugging in or unplugging the cooling module.

8. Switch ON the instrument using the main power switch on the rear panel of the instrument.
9. Start the software to connect to the instrument. For instrument control via software refer to Chapter 8 Operation of SPARK with SparkControl Software.



**WARNING:** Do not reach into the instrument while it is in operation!

### 3.9 Switching the Instrument Off

1. Ensure that the plate transport is empty.
2. In the SparkControl software, disconnect from the instrument by selecting Exit in the File menu in the Method Explorer (see 8.5.4 Menu Bar) or Shut Down via the expandable Navigation bar on the left side of the Dashboard.
3. Switch OFF the instrument by either using the onboard control button or the main power switch on the rear panel of the instrument.



**CAUTION:** When switched off wait at least 5 seconds until switching the instrument on again. Instrument errors can occur.

### 3.10 Preparing the Instrument for Shipping

Before shipping an instrument with integrated cooling module (Te-cool) the cooling liquid has to be removed from the cooling system. This procedure must be done by a service technician.



**CAUTION:** Do not ship an instrument with integrated cooling module! Only Tecan authorized service technicians are allowed to prepare instrument for transportation. Residual cooling fluid might damage the instrument.

Before shipping the instrument, perform the parking procedure to avoid any damage to the optics and plate transport (see 3.10.1 Parking Procedure).

After the parking procedure has been performed, the plate carrier transport locks must be installed (see 3.10.2 Installing the Plate Carrier Transport Locks).

Before shipping, the instrument (including the injector(s), heater/stirrer, humidity cassette, NanoQuant Plate and any other external optional components) must be thoroughly disinfected (see 7.3 Instrument Decontamination/Disinfection). For injector maintenance, see 14.3 Injector Cleaning and Maintenance).



**CAUTION:** Switch off the instrument before plugging in or unplugging the injector module.



**CAUTION:** Switch off the instrument before plugging in or unplugging the cooling module.

The instrument (including the injector(s), heater/stirrer, humidity cassette, NanoQuant Plate and any other external optional components) must be shipped in the original packaging.



**WARNING:** Always move the injector and the heater/stirrer separately, as the two units are not attached to each other. When carried together, one of the units can easily fall and become damaged.

### 3.10.1 Parking Procedure

1. Ensure that the plate transport is empty.
2. Ensure that the injector (dummy) is removed from the injector port.
3. In the SparkControl software, disconnect from the instrument by selecting **Exit** in the File menu in the Method Explorer (see 8.5.4 Menu Bar) or Shut Down via the expandable Navigation bar on the left side of the Dashboard.
4. Remove filter slides by using the onboard control button in the front of the instrument.
5. Move out the plate transport by using the onboard control button in the front of the instrument.
6. Switch OFF the instrument by using the onboard control button in the front of the instrument to start parking procedure. Starting the parking procedure may take a few seconds.
7. Switch OFF the instrument by using the main power switch on the rear panel of the instrument.
8. Install the plate carrier transport lock (see 3.10.2 Installing the Plate Carrier Transport Locks).



**CAUTION:** The parking procedure has to be performed and the transport lock must be mounted before shipping. If the instrument is shipped without these safety measures, the instrument guarantee is rendered null and void. Use original packaging for shipping.

### 3.10.2 Installing the Plate Carrier Transport Locks

The instrument must be shipped with the plate carrier locked into place, so that it cannot become damaged. Before the instrument can be shipped, the transport locks (foam pieces) must be inserted using the following procedure:

1. Ensure that the instrument is disconnected from the main power supply.
2. Hold the plate carrier compartment door down and insert the white piece of foam (shown below) into the left compartment.

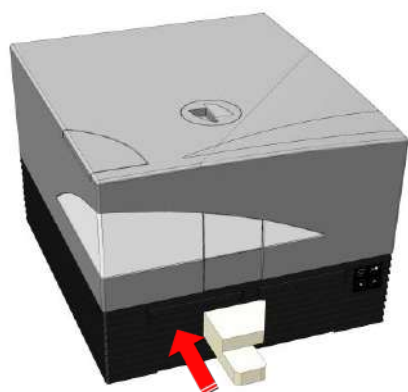

3. With the foam piece inserted, turn it 90° clockwise, so that the pointed end sticks down into the space between the two compartment openings. This piece of foam holds the compartment doors open.

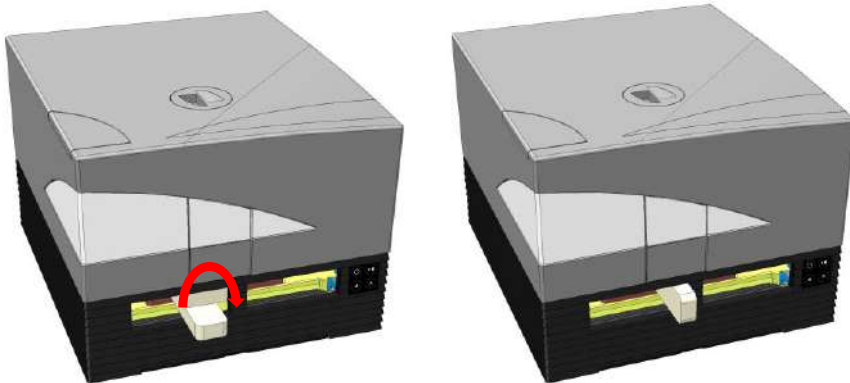

4. Move the plate carrier out carefully by hand until it lightly presses against the inserted white piece of foam from behind and cannot be moved out further.



5. Insert the bottom piece of foam first and then interlock the top piece into place (see picture below).

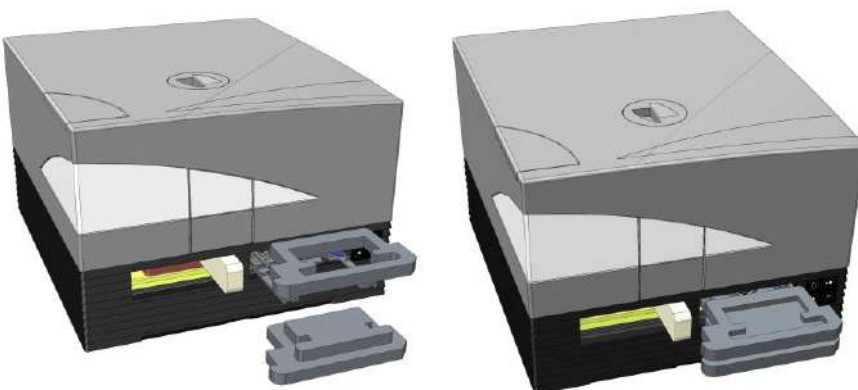



6. Move the plate carrier into the right compartment manually as far as it can go by pushing on the pieces of foam on the plate carrier.

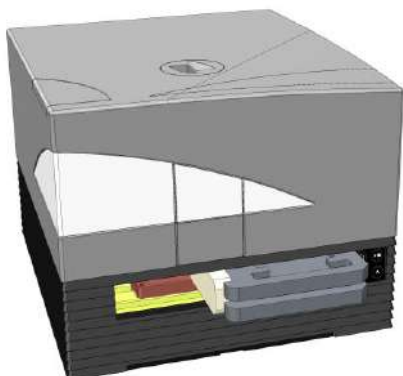

7. Insert the piece of foam into the left plate carrier compartment (see picture below).

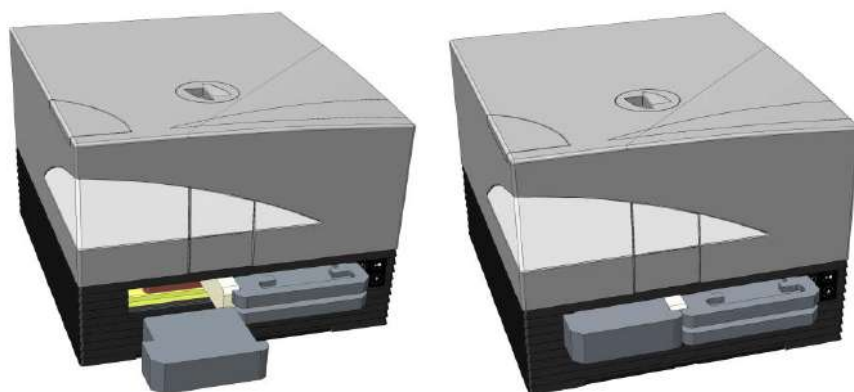

8. Tape the filter compartment doors shut (see picture below).





## 4 Plate Control

The plate transport is capable of moving horizontally (in the x- and y-directions) as well as vertically (in the z-direction), so that for each measurement mode, top or bottom, the optimal measurement position can be reached regardless of which plate type or filling volume is used. The movement speed is optimized according to the plate type and detection mode.



**CAUTION:** Before starting measurements, make sure that the microplate is inserted correctly. The position of well A1 has to be on the upper left side.

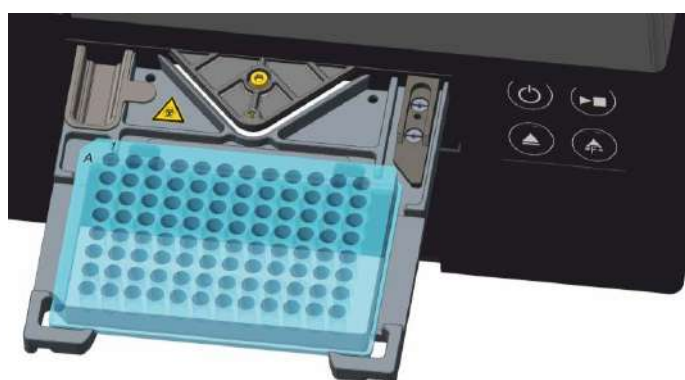

Figure 2: Microplate on the plate carrier with the A1 well in the upper left-hand corner



**CAUTION:** Tecan Austria GmbH has taken great care when creating the Plate Definition Files (.pdfx) that are delivered with the instrument.

We take every precaution to ensure that the plate heights and well depths are correct according to the defined plate type. These parameters are used to determine the minimum distance between the top of the plate and the ceiling of the measurement chamber. Additionally, Tecan Austria adds a very small safety gap to prevent any damage that may occur to the measurement chamber as a result of small changes in plate height. This does not affect the performance of the instrument. The user **MUST** ensure that the plate definition file selected corresponds to the actual plate being used. The safety gap cannot be calculated by the instrument if the plate used does not match the pdf selected.



**CAUTION:** Users should also take care that no potential fluorescent or luminescent contamination lies on top of the plate as droplets, and also be aware that some plate sealers leave a sticky residue that should be removed before measurement.

## 4.1 Z-Position

The height of the objective above the sample can be adjusted using the Z-position function. As excitation light is reflected by the sample fluid, the Z-adjustment helps to maximize the signal-to-noise ratio. For further details about Z-positioning, see chapter 12.13 Optimizing Fluorescence and Fluorescence Polarization Measurements.

## 4.2 Shaking

The SPARK is capable of plate shaking before start of a measurement or in between kinetic cycles. Three shaking modes are available: linear, orbital and double orbital. The shaking amplitude can be selected from 1 to 6 mm in steps of 0.5 mm. The frequency is a function of the amplitude. The shaking duration is selectable from 1-3600 seconds.

## 4.3 Incubation/Cooling Position

The SPARK has a predefined incubation/cooling position with an optimum temperature distribution. These positions can be used for shaking or waiting steps within a measurement run.

## 4.4 Lid Lifter

The lid lifter option consists of a permanent magnet and a magnetic pad. The magnetic pad can be mounted on the lids of all commonly used microplate types with a maximum lid height of 11.5 mm. The magnetic mechanism is regulated by the software.

To attach the pad, peel the paper backing off of the metal disk and stick the pad onto the center of the lid.



**CAUTION:** The lid height must not exceed 11.5 mm.



**CAUTION:** Clean the lid with 70% ethanol before attaching the magnetic pad.



Figure 3: Lid with magnetic pad mounted in the middle



**CAUTION:** Make sure that the magnetic pad is mounted on the plate lid if **Removable Lid** or **Humidity Cassette** is activated in the method.



**CAUTION:** Mount the magnetic pad in the middle of the appropriate plate lid to guarantee optimal performance.

The lid lifter option is used to temporarily remove the lid of the microplate to execute, e.g. injection steps or measurement steps within the workflow of a long term experiment thus avoiding sample evaporation.

The lid lifter in combination with the gas module option can also be used to improve the gas exchange between the medium and the surrounding environment in case of cell based studies. Ventilation steps can be inserted simply into the workflow and timed accordingly.

The lid lifter option can also be used in combination with Tecan's humidity cassette (refer to chapter 15 Environmental Control).

## 4.5 Securing the RoboFlask Cell Culture Vessels

A centering clamp is necessary to secure the RoboFlask Cell Culture Vessels (Corning, Inc.) onto the plate carrier. This centering clamp must be installed by the user before starting measurements using RoboFlask Cell Culture Vessels, follow the given instructions.

- Move the plate transport out
- Put the centering clamp on the plate fixing mechanism as indicated in the figure below.
- Fasten the screw by using the enclosed screw driver, taking care to avoid putting pressure on the plate carrier.



**CAUTION:** Do not put pressure on the plate carrier when attaching the centering clamp. A bent plate carrier can negatively influence the performance of the instrument and may require service.

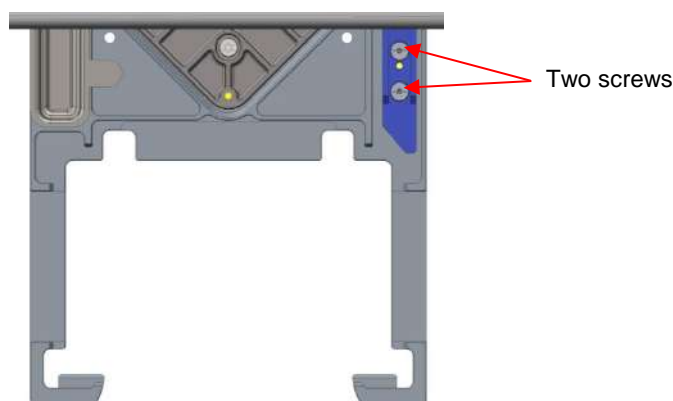

Figure 4: Centering clamp for the RoboFlask Cell Culture Vessels



**CAUTION:** Do not use the RoboFlask Cell Culture Vessels without the centering clamp. This can result in damage to the instrument.



**NOTE:** By using a higher number of flashes and/or a settle time result will be more accurate.

## 5 Spark Platform

The SPARK is a multimode reader platform consisting of two different instrument variants: SPARK 10M and SPARK 20M. Each instrument variant can be equipped with a large number of modules and functions. The following chapter provides an overview.

### 5.1 Overview of Available Modules and Functions for SPARK 10M

The SPARK 10M is compatible with plate formats from 1-well to 384-wells.

Module/Function	Description
Absorbance	Fast absorbance scan included.
NanoQuant Plate	For low volume nucleic acid samples; Ready to use Apps available for nucleic acid quantitation and labeling efficiency.
Cuvette module	For Absorbance measurements. Ready to use App available.
Luminescence Standard	Attenuation function (OD1 and OD2).
Luminescence Enhanced	Attenuation function (OD1, OD2 and OD3). Wavelength discrimination. Luminescence scan included.
Alpha Technology	AlphaScreen, AlphaLISA and AlphaPlex.
Fluorescence Standard Top	Filter-only-, Monochromator-only- or Fusion Optics-System available.
Fluorescence Standard Bottom	Filter-only-, Monochromator-only- or Fusion Optics-System available. VIS or UV-VIS fiber.
Fluorescence Bottom Area Scan	Up to 100x100 data points/well
Fluorescence Standard Polarization	Filter-only-, Monochromator-only- or Fusion Optics-System available. >300 nm or >390 nm fiber.
Cell Module	Cell counting and viability in disposable (Ready to use Apps). Cell confluence in microplates.
Injector	One or two injector options with different syringe sizes.
Heater&Stirrer	Both injector options can be equipped with Heater/Stirrer module.
Heating	4° C above ambient up to 42° C.
Cooling (Te-Cool)	18° C up to 42 °C.
Gas control	CO <sub>2</sub> only or CO <sub>2</sub> and O <sub>2</sub> .
Humidity Control	Evaporation protection for different plate formats for long-term studies (with cells).
Lid lifter	Interactions during long-term studies (gas exchange, injection)

## 5.2 Overview of Available Modules and Functions for SPARK 20M

The SPARK 20M is compatible with plate formats from 1-well to 1536-wells.

Module/Function	Description
Absorbance	Absorbance (Fast absorbance scan included) or Absorbance Enhanced (Up to 1536-well)
NanoQuant Plate	For low volume nucleic acid samples; Ready to use Apps available for nucleic acid quantitation and labeling efficiency.
Cuvette module	For Absorbance measurements. Ready to use app available.
Luminescence Standard	Attenuation function (OD1 and OD2). Up to 384-well.
Luminescence Enhanced	Attenuation function (OD1, OD2 and OD3). Wavelength discrimination. Luminescence scan included. Up to 1536-well
Alpha Technology	AlphaScreen, AlphaLISA and AlphaPlex. Alpha Enhanced (Up to 1536-well)
Fluorescence Standard Top	Filter-only-, Monochromator-only- or Fusion Optics-System available. Up to 384-well.
Fluorescence Standard Bottom	Filter-only-, Monochromator-only- or Fusion Optics-System available. VIS or UV-VIS fiber. Up to 384-well.
Fluorescence Standard Bottom Area Scan	Up to 100x100 data points/well
Fluorescence Standard Polarization	Filter-only-, Monochromator-only- or Fusion Optics-System available. >300 nm or >390 nm fiber. Up to 384-well.
Fluorescence Enhanced Top	Filter-only-, Monochromator-only- or Fusion Optics-System available. More sensitive than Standard option. Up to 1536-well
Fluorescence Enhanced Bottom	Filter-only-, Monochromator-only- or Fusion Optics-System available. Equipped with UV-VIS fiber. More sensitive than Standard option. 1536-well optional.
Fluorescence Enhanced Bottom Area Scan	up to 100x100 data points/well
Fluorescence Enhanced Polarization	Filter-only-, Monochromator-only- or Fusion Optics-System available. Equipped with >300 nm fiber. More sensitive than Standard option. Up to 1536-well



Module/Function	Description
Cell Module: Cell Counting and Confluence	Cell counting and viability in disposable (Ready to use Apps). Cell confluence in microplates.
Injector (one or two injectors)	One or two injector options with different syringe sizes.
Heater&Stirrer	Both injector options can be equipped with Heater/Stirrer module.
Heating	4° C above ambient up to 42° C.
Cooling (Te-Cool)	18° C up to 42 °C.
Gas control	CO <sub>2</sub> only or CO <sub>2</sub> and O <sub>2</sub> .
Humidity Control	Evaporation protection for different plate formats for long-term studies (with cells).
Lid lifter	Interactions during long-term studies (gas exchange, injection)

Fluorescence Standard and Fluorescence Enhanced options cannot be installed together in one instrument (SPARK 20M).



## 6 Instrument Specifications



**NOTE:** All specifications are subject to change without prior notification.

The table below lists the technical specifications of the basic instrument:

### General

Parameters	Characteristics
Measurement	Software controlled
Interface	USB 2.0 or higher
Fusion Optics system	Monochromator and Filter (external filter exchange) based
Microplates	From 1 well to 1536 well SBS plates
Temperature control	From 18° C up to 42 °C
Plate shaking	Linear, orbital and double orbital shaking
Light source	High energy Xenon flash lamp
Optics	Fused Silica Lenses
Fluorescence detector	Low dark current photomultiplier tube
Luminescence detector	Low dark count photomultiplier tube
Absorbance detector	Silicon photodiode
Power supply	100-120 V and 220-240 V, auto-sensing
Power consumption	170 VA

### Physical

Parameters	Characteristics		
Outer dimensions	Width:	494 mm	(19.5 in.)
	Height:	395 mm	(15.5 in.)
	Height (with cooling module):	510 mm	(20.1 in.)
	Height (with injector carrier):	455 mm	(17.9 in.)
	Depth:	557 mm	(21.9 in.)
	Depth (carrier moved out):	699 mm	(27.5 in.)

## Weight

Parameters	Characteristics	
Instrument	40 kg	(88 lb.)
Instrument with cooling module	50 kg	(110 lb.)
Injector (2 channel)	4.0 kg	(8.8 lb.)
Heater/Stirrer	2.7 kg	(6 lb.)

## Environmental

Parameters	Characteristics	
Operating temperature	+15 °C to +35 °C	59 °F to 95 °F
Operating temperature with active cooling	+15 °C to +30 °C	59 °F to 86 °F
Transportation temperature	-30 °C to +60 °C	-22 °F to +140 °F
Operating humidity	20 % to 90 % (non-condensing)	
Operating humidity with active cooling	20 % to 80 % (non-condensing)	
Transportation humidity	20 % to 95 % (non-condensing)	
Operating pressure	700-1050 hPa	
Transportation pressure	500-1100 hPa	
Overvoltage category	II	
Pollution degree	2	
Usage	Commercial	
Noise level	< 60 dBA	
Method of disposal	Electronic waste (infectious waste)	

# 7 Cleaning and Maintenance

## 7.1 Introduction

- For maintenance of the NanoQuant, see 16.4 NanoQuant Maintenance.
- For injector maintenance, see 14.3 Injector Cleaning and Maintenance.
- For maintenance of the Cell chip adapter, see 13.3.3 Maintenance and Cleaning of the Cell Chip Adapter.
- For maintenance of the Cooling Module, see 15.2.7 Maintenance.

The cleaning and maintenance procedures are important in order to prolong the instrument's life and to reduce the need for service.

This section contains the following information:

- Liquid Spills
- Instrument Disinfection
- Disinfection Procedure
- Safety Certificate
- Disposal



**CAUTION:** Keep the plate transport clean! Take special care of the clip mechanism that secures the microplates. Insufficient plate fixation can lead to instrument damage. Excessive soiling requires service.

## 7.2 Liquid Spills

1. Wipe up the spill immediately with absorbent material.
2. Dispose of contaminated material appropriately.
3. Clean the instrument surfaces with a mild detergent.
4. For biohazard spills, clean with B30 (Orochemie, Germany).
5. Wipe cleaned areas dry.



**CAUTION:** Always switch off the instrument before removing any kind of spills on the instrument. All spills must be treated as potentially infectious. Therefore, always adhere to applicable safety precautions (including the wearing of powder-free gloves, safety glasses and protective clothing) to avoid potential infectious disease contamination.

Additionally, all resulting waste from the clean-up procedure must be treated as potentially infectious and the disposal must be performed according to the information given in chapter 7.4 Disposal.

If the spill occurs in the instrument, a service technician is required.

## 7.3 Instrument Decontamination/Disinfection



**WARNING:** The disinfection procedure should be performed according to national, regional, and local regulations.



**WARNING:** All parts of the instrument that come into contact with potentially infectious or any hazardous material must be treated as potentially infectious areas.

It is advisable to adhere to applicable safety precautions (including the wearing of powder-free gloves, safety glasses and protective clothing) to avoid potential infectious disease contamination when performing the disinfection procedure.



**WARNING:** It is very important that the instrument is thoroughly disinfected before it is removed from the laboratory or before any service is performed on it.



**WARNING:** The disinfection procedure for the injector described in this chapter is valid only for the cover of the injector box. For cleaning and maintenance of the syringes, tubes and pumps, please refer to 14.3 Injector Cleaning and Maintenance.



**CAUTION:** Ensure that the microplate is removed from the instrument before it is prepared for shipment. If a microplate is left in the instrument, fluorescent solutions may spill onto the optical parts and damage the instrument.

Before the instrument is returned to the distributor or service center, all outer surfaces and the plate transport must be disinfected and a safety certificate must be completed by the operating authority. If a safety certificate is not supplied, the instrument may not be accepted by the distributor or service center or custom authorities may hold it.

### 7.3.1 Disinfection Solutions

The instrument (Front, Cover, Plate transport) should be disinfected using the following solution:

- B30 (Orochemie, Germany)



**CAUTION:** The disinfection procedure should be performed by authorized trained personnel in a well-ventilated room wearing disposable gloves and protective glasses and clothing.



**WARNING:** The disinfection procedure for the injector is valid only for the cover of the injector box. For cleaning and maintenance of the syringes, please refer to 14.3 Injector Cleaning and Maintenance.

### 7.3.2 Disinfection Procedure



**CAUTION:** The surface disinfectant can negatively influence the performance of the instrument, if it is applied or accidentally gets inside the instrument.



**CAUTION:** Make sure that the microplate has been removed from the instrument before starting disinfection procedure.

If the laboratory has no specific disinfection procedure the following procedure should be used to disinfect the outside surfaces of the instrument:

1. Wear protective gloves, protective glasses and protective clothing.
2. Prepare a suitable container for all disposables used during the disinfection procedure.
3. Disconnect the instrument from the main power supply.
4. Disconnect the instrument from any external components that are used.
5. Carefully wipe all outside surfaces of the instrument with a lint-free paper towel soaked in the disinfection solution.
6. Perform the same disinfection procedure on the plate carrier.
7. Perform the disinfection procedure on any external components that are used with the instrument.
8. Complete the Safety Certificate and attach it to the outside of the box so that it is clearly visible.

See below for information about the Safety Certificate, which must be completed before the instrument is returned to the distributor/ service center.



**CAUTION:** The plate transport should only be moved manually when the instrument is disconnected from the main power supply.

### 7.3.3 Safety Certificate

The Safety Certificate must be requested from your local Tecan Customer Support (refer to <http://www.tecan.com/> for contact information).

To ensure the safety and health of personnel, our customers are kindly asked to complete two copies of the **Safety Certificate** and attach one copy to the top of the container in which the instrument is returned (visible from the outside of the shipping container!) and attach the other copy to the shipping documents before shipping it to the service center for service or repair.

The instrument must be decontaminated and disinfected at the operating authority's site before shipping (see chapter 7.3.2 Disinfection Procedure).

The decontamination and disinfection procedure must be performed in a well-ventilated room by authorized and trained personnel wearing disposable powder-free gloves, safety glasses and protective clothing.

The decontamination and disinfection procedure must be performed according to national, regional, and local regulations.

If a Safety Certificate is not supplied, the instrument may not be accepted by the service center.

## 7.4 Disposal

Follow laboratory procedures for bio-hazardous waste disposal, according to national and local regulations.

This section provides instructions on how to lawfully dispose of waste material accumulating in connection with the instrument.



**CAUTION:** Observe all federal, state and local environmental regulations.



**CAUTION:** Directive 2012/19/EU on waste electrical and electronic equipment (WEEE)  
Negative environmental impacts associated with the treatment of waste:

- Do not treat electrical and electronic equipment as unsorted municipal waste
- Collect waste electrical and electronic equipment separately

### 7.4.1 Disposal of Packaging Material

According to Directive 94/62/EC on packaging and packaging waste, the manufacturer is responsible for the disposal of packaging material.

#### Returning Packaging Material

If you do not intend to keep the packaging material for future use, e.g. for transport and storage purposes, return the packaging of the product, spare parts and modules via the field service engineer to the manufacturer.

### 7.4.2 Disposal of Operating Material



**CAUTION:** Biological hazards can be associated with the waste material (i.e. microplate) of the process run on the SPARK.

Treat the used microplate, cell chips, other disposables, and all substances used, in accordance with good laboratory practice guidelines.

Inquire about appropriate collecting points and approved methods of disposal in your country, state or region.



### 7.4.3 Disposal of the Instrument

Please contact your local Tecan service representative before disposing of the instrument.



**CAUTION:** Always disinfect the instrument before disposing.

Pollution Degree	2 (IEC/EN 61010-1)
Method of Disposal	Contaminated waste



**CAUTION:** Depending on the applications, parts of the instrument may have been in contact with biohazardous material. Make sure to treat this material according to the applicable safety standards and regulations.

Always decontaminate all parts before disposal.



# 8 Operation of SPARK with SparkControl Software

## 8.1 Area of Application

The SparkControl software is an easy-to-use and flexible tool, which gives the user control over Tecan SPARK multimode reader.



**NOTE:** Depending on the instrument connected and the modules installed, certain SparkControl features may be disabled or not visible.

## 8.2 System Requirements

The following hardware requirements and operating system requirements have to be met to use the SparkControl software:

	Supported	Recommended
PC	Windows compatible PC with a Pentium compatible processor running at 2 GHz (Dual Core)	2.4 GHz (Quad Core)
Operating System	Windows 7 (32-bit) – SP1	
	Windows 7 (64-bit) – SP1 Editions: Ultimate, Enterprise	Windows 7 (64-bit) – SP1 Edition: Professional
	Windows 8.1 (32-bit)	
	Windows 8.1 (64-bit) Editions: Pro, Enterprise <b>For Cell Confluence measurements, a 64-bit system is mandatory!</b> <b>Windows RT NOT supported!</b>	
Memory	Windows 7, Windows 8.1 (32-bit): 2 GB RAM	4 GB RAM
	Windows 7, Windows 8.1 (64-bit): 4 GB RAM For Cell Confluence measurements with well diameters > 10 mm, 8 GB of RAM is required! For typical 96-well diameters, 4 GB RAM is required.	8 GB RAM

	Supported	Recommended
Space Requirements	6 GB For Cell counting measurements: 40 GB For Cell Confluence measurements, 500 GB is required.	10 GB For Cell counting measurements: 160 GB For Cell Confluence measurements, 1000 GB is recommended.
Monitor	Super VGA Graphics	
Resolution	1280 x 1024	1680 x 1050
Color Depth	256	
Mouse	Microsoft mouse or compatible pointing device	
Communication	1 x USB 2.0	2 x USB 2.0
Devices	Windows 7, Windows 8.1: DirectX 9 graphics device with WDDM 1.0 or higher driver	
.NET	Microsoft.NET Framework 4.5 (4.5.1). <b>Windows Versions Prior to Windows 8:</b> The required .NET version is installed automatically alongside any existing versions (2.0 is part of Windows 7 SP1, which is required). <b>Windows 8.1:</b> Microsoft.NET Framework 3.5.1 (including 2.0) must first be installed before installing SparkControl! The user will be prompted to install the required .NET framework (4.5), if it is not already present.	
Microsoft Excel	2007 The export mechanism writes files according to the Office Open XML file format (xlsx)	2010

## 8.3 Software Installation



**NOTE:** You must have administrative rights to install the software.



**NOTE:** Install the software before plugging the instrument into the computer.

The SparkControl software is installed using the following procedure:

1. Insert the installation USB stick.
2. Open the Windows Explorer and browse to folder **Software/<article number>SparkControl Vx.y** on the installation stick. Double-click **SparkControl <version>\_Setup.exe** to start the installation procedure.
3. The software will be installed to C:\Program Files\Tecan. The installation destination can be changed optionally.
4. Select **Install** to start the software installation.

### 8.3.1 Uninstall/Repair Installation

If for any reason the current version of the SparkControl software needs to be reinstalled, proceed as follows:

1. Insert the installation USB stick.
2. Open the Windows Explorer and browse to folder **Software** on the installation stick.
3. Double-click **SparkControl <version>\_setup.exe** to start the installation procedure.
  - Select **Uninstall** to uninstall the current software version, or
  - Select **Repair** to repair the installation and restore the original program files.

## 8.4 Starting the SparkControl

From the Windows Start menu, select Tecan>SparkControl Dashboard or Method Editor to start the program.

### 8.4.1 Connecting Instruments



**CAUTION:** Do not open the instrument lid during operation!

Each connected instrument is represented by a corresponding tile in the Dashboard (refer to chapter 8.8 Dashboard).



**NOTE:** The SparkControl supports the connection of a maximum of 4 instruments. However, working in parallel is not possible – only one instrument can be used at a time.

## 8.5 Method Editor

### 8.5.1 Structure

The Method Editor is used to set up workflows.

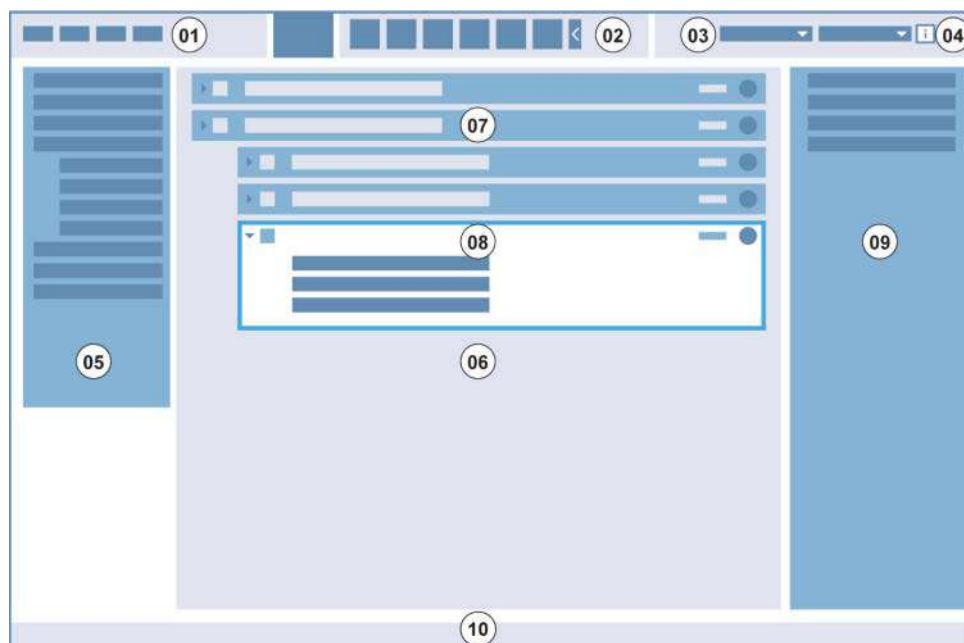

01 Menu bar; 02 Toolbar; 03 Drop-down list; 04 Button for opening the Info pane; 05 Control bar; 06 Workflow pane; 07 Collapsed strip; 08 Expanded strip; 09 Info pane; 10 Status bar

Menu bar	<b>01</b>	Contains a drop-down menu of editor and reader functions (e.g. File, Edit, Settings)
Toolbar	<b>02</b>	Contains icons for commonly used editor functions (e.g. New, Save)
Drop-down lists	<b>03</b>	Select and start functions related to the respective software application or instrument connected (e.g. Select app)
Control bar	<b>05</b>	Contains strips for defining workflows
Workflow pane	<b>06</b>	Insert strips into this pane to define the workflow. Default settings can also be adjusted here
Info pane	<b>09</b>	Displays additional information about the workflow
Status bar	<b>10</b>	Displays information about the connected instrument (e.g. name, temperature)

Each workflow can be created easily by dragging and dropping the process steps into a sequence according to the application. The application workflow is then visible to the user in the Workflow pane and can be saved for future use.

## 8.5.2 Control Bar

See chapter 8.6 Control Bar for details.

## 8.5.3 Workflow Pane

See chapter 8.7 Workflow Pane for details.

## 8.5.4 Menu Bar

### File

New	Open a new measurement workflow. If an empty document is to be opened, you will be asked to save the current workflow. Click <b>Yes</b> to save the current workflow or click <b>No</b> to create a new workflow without saving the previous one. Click <b>Cancel</b> to leave the dialog box.
Open	Open an existing SparkControl method from the selected folder. If you want to open an existing method while another one is still open, you will be asked if you want to save the workflow. Click <b>Yes</b> to save the current workflow to a certain destination or click <b>No</b> to create a new workflow without saving the previous one. Click <b>Cancel</b> to leave the dialog box.
Save	Save the current workflow as a SparkControl method.
Save as	Save the current workflow as a SparkControl method under a different name.
Onboard-Start	Save the current workflow as a SparkControl method that can be started via the instrument Onboard-Start button.
Export	Export a SparkControl method from the Method File Explorer.
Import	Import a SparkControl method to the Method File Explorer.
Exit	Exit and close the program.

### Edit

Delete	Delete the selected strip.
Outdent	Outdent the selected strip.
Indent	Indent the selected strip.

### View

Info pane	Show or hide the Info pane.
Status bar	Show or hide the Status bar.
Collapse all	Collapse all strips in the Workflow pane to view only one line of text per strip.
Expand all	Expand all strips in the Workflow pane to show all visible parameters.

### Instrument

Movements	Define plate and filter movements: Click <b>Plate Out Left</b> to move the plate carrier out left. Click <b>Plate Out Right</b> to move the plate carrier out right. Click <b>Plate In</b> to move the plate carrier in. Click <b>Ex Filter</b> to move the excitation filter slide out. Click <b>Em Filter</b> to move the emission filter slide out. When a measurement is started, the plate is moved into the instrument automatically.
-----------	---

Temperature	Set the target temperature of the instrument manually.
Gas	Set the target gas concentration of the instrument manually.
Z-Position	Define the Z-position for measurement prior to measurement start.
Filter	Define filters located on a filter slide.
Mirror	Define a custom dichroic mirror.
Injector	Prime/rinse/backflush injectors.









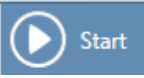

## Help

View Help	Open the online help file and allows you to browse through the different topics.
Tecan Homepage	Open your favorite browser and navigates to the Tecan homepage.
Contact Tecan	Open a direct contact link to Tecan.
Exception History	<p>Open the Exception History dialog with a list of exceptions (i.e. instrument &amp; software failures) resulting from a measurement. Every time an exception occurs and an error is displayed, all relevant information is collected and saved in a zip-file. Each of these zip-files leads to an entry in this list.</p> <p>Select a zip-file and send it to Tecan as this information is helpful to the customer support to track problems.</p>
About Box	About SparkControl including the software version number.

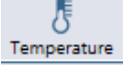

## 8.5.5 Toolbar

The following commands are accessible via the toolbar:

	Open a new measurement workflow
	Open an existing file
	Save the current workflow
	Start the measurement
	Move plate out
	Move plate in
	Move Ex Filter out
	Move Em Filter out
	Open the Gas Control window
	Open the Temperature Control window
	Open the Z-position window

## 8.5.6 Instrument

Change the working instrument if more than one instrument is connected.

## 8.5.7 Select Component

Switch to the SparkControl components, **Dashboard**, **Settings** and **Screencasts**.

## 8.5.8 Select App

Start one of the available Tecan apps. Select an app to start it automatically.

## 8.6 Control Bar

This chapter describes the Control bar of the Method Editor.

The Control bar is divided into four sections. Each section contains strips used to create an individual workflow. Depending on the instrument connected and the modules installed, the available strips may vary; e.g. if the instrument is not equipped with a fluorescence polarization module, the fluorescence polarization strip is not visible in the detection section.

Create a workflow by double-clicking the selected strip or by dragging and dropping it into the Workflow pane.

The following strips are available:

<b>Plate</b>	<ul style="list-style-type: none"> <li>Cuvette</li> <li>Plate</li> <li>Part of Plate</li> <li>Well</li> </ul>
<b>Detection</b>	<ul style="list-style-type: none"> <li>Absorbance</li> <li>Absorbance Scan</li> <li>Alpha Technology</li> <li>Cell Counting</li> <li>Cell Confluence</li> <li>Fluorescence Intensity</li> <li>TR Fluorescence Intensity</li> <li>Fluorescence Intensity Scan</li> <li>Fluorescence Polarization</li> <li>Luminescence</li> <li>Luminescence Multicolor</li> <li>Luminescence Scan</li> </ul>
<b>Action</b>	<ul style="list-style-type: none"> <li>Shaking</li> <li>Wait</li> <li>Injector</li> <li>Condition</li> <li>Temperature</li> <li>Gas</li> <li>Move Plate</li> <li>User Intervention</li> <li>Comment</li> </ul>
<b>Kinetic</b>	<ul style="list-style-type: none"> <li>Kinetic Loop</li> </ul>

## 8.6.1 Plate

### Plate Strip

This strip is used to define the plate format used for the measurement.

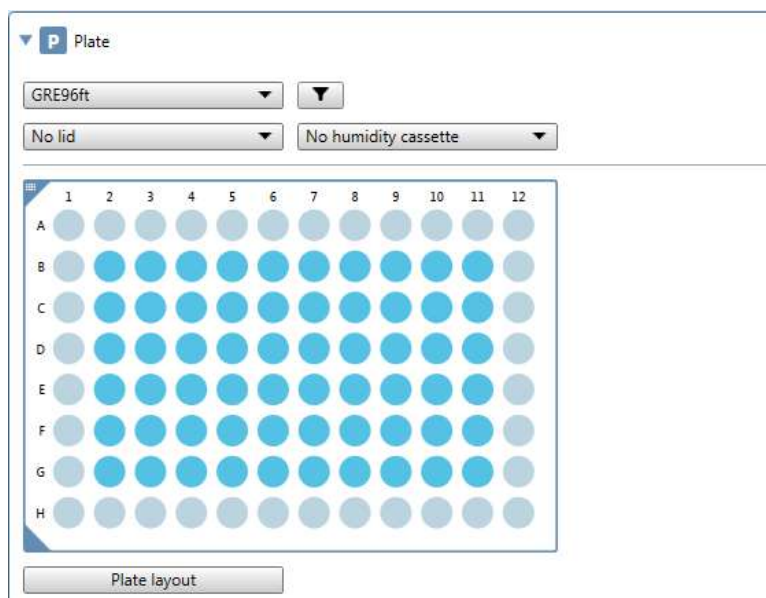

Figure 5: Plate strip

The **Plate** strip contains the following elements:

<b>Plate definition</b>	Select the plate to be used for the measurement. The list of available plate files can be filtered according to the <b>Number of wells</b> , <b>Manufacturer</b> , <b>Material</b> and <b>Cell</b> (plates for cell based assays).
<b>Plate lid</b>	<ul style="list-style-type: none"> <li>Select <b>No lid</b> if using a plate without a cover</li> <li>Select <b>Lid</b> if using a plate with a cover</li> <li>Select <b>Removable lid</b> (this option is only available for instruments with the lid lifting module)</li> </ul>
<b>Humidity cassette</b>	<p>This option is only available for instruments with the lid lifting module</p> <ul style="list-style-type: none"> <li>Select <b>No humidity cassette</b> if using a plate without a humidity cassette</li> <li>Select <b>Humidity cassette–Large</b> if using a large humidity cassette</li> <li>Select <b>Humidity cassette–Small</b> if using a small humidity cassette</li> </ul>
<b>Plate</b>	Select the plate area used for the measurement. The measurement will automatically measure all selected wells of the plate.



**NOTE:** Use the **Fit to window** control located at the left edge of the Plate when defining the plate area for a 1536 well plate.



**CAUTION:** A removable lid is used in combination with the lid lifter. Please make sure to attach a magnetic pad to the plate lid before use.

## Defining the Plate Layout

Click **Plate Layout** to view and change the plate layout.

<b>Identifiers</b>	<p><b>None</b> to delete defined identifiers</p> <p><b>BL</b> (Blank)</p> <p><b>SM</b> (Sample)</p> <p><b>ST</b> (Standard)</p> <p><b>PC</b> (Positive control)</p> <p><b>NC</b> (Negative control)</p> <p><b>LPC</b> (Low positive control)</p> <p><b>HPC</b> (High positive control)</p> <p><b>CL</b> (Calibrator)</p> <p><b>RF</b> (Reference)</p> <p><b>BF</b> (Blank for polarization reference)</p>
<b>Identifier No.</b>	<p>The identifier number is used to assign the same identifier to replicates that belong together. The identifier number is available only for the samples and standards.</p>
<b>No. of replicates</b>	<p>Define the number of replicates for the selected identifier type. There are two options available:</p> <ul style="list-style-type: none"> <li>Define a fixed number of replicates. This number defines how many replicates are intended for this identifier. The selected wells are then filled with this number of replicates. Therefore the number of selected wells must be a multiple of the entered number of replicates. The fixed number definition is only available for the <b>Samples</b> and <b>Standards</b>. The number of replicates for the <b>References</b>, <b>Controls</b> and <b>Blanks</b> is always identical to the number of selected wells.</li> <li>Select <b>All</b> to define all selected wells as replicates of one identifier. This selection is automatically active for the <b>References</b>, <b>Controls</b> and <b>Blanks</b>.</li> </ul>
<b>Direction</b>	<p>Define the direction for filling the selected well area with the respective identifier:</p> <ul style="list-style-type: none"> <li><b>Horizontal</b> (i.e. the fill order is horizontal)</li> <li><b>Vertical</b> (i.e. the fill order is vertical)</li> </ul> <p>The fill direction is available for the <b>Identifier No.</b> and <b>No. of replicates</b>.</p>

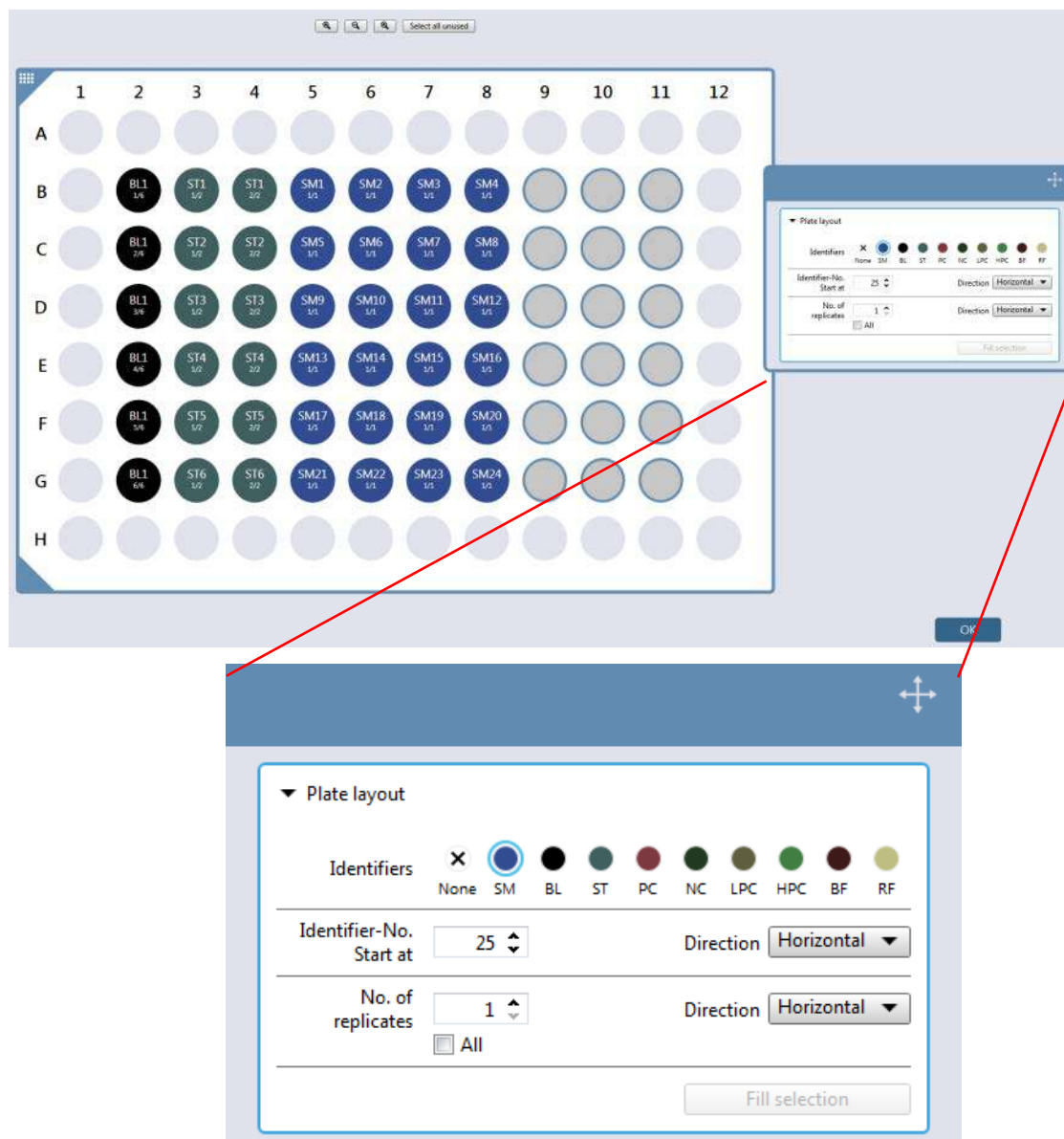

Figure 6: Defining the plate layout

An identifier can be assigned to a well or a well area as follows:

- 1) Select the plate area.
- 2) Select **Plate Layout**.
- 3) Select the wells on the plate to be filled with the selected identifier.
- 4) Select the identifier.
- 5) Select **Fill selection**: the identifiers and their colors are displayed in the plate layout. (It is also possible to fill the selection by double-clicking the selected identifier).

Optional:

- Define the **Identifier No.** or use the default settings.
- Define the **No. of replicates** or use the default settings.

## Part of Plate

Use **Part of Plate** to define sub-areas within the previously selected plate area.

Measurement strips below each sub-area will be applied only to the respective sub-area.

### Example:

The screenshot displays the software configuration for a plate and its sub-areas. The 'Plate' section is set to 'GRE96ft' with 'No lid' and 'No humidity cassette'. The plate layout shows a full 96-well plate (A1-H12) with all wells highlighted in blue. The 'Part Of Plate' section shows the same plate with wells A1-H6 highlighted in blue and wells A7-H12 highlighted in grey. Below the plate layout, there are three measurement strips:

▶ <b>D</b> Fluorescence Intensity	Name <b>Label 1</b>	Emission wavelength 535	Excitation wavelength 485
▶ <b>P</b> Part Of Plate	Plate area <b>multiple</b>		
▶ <b>D</b> Absorbance	Name <b>Label 2</b>	Measurement wavelength 492	

Figure 7: (Plate: A1-H12; Part of Plate: A1-H6; FI; Part of Plate: A7-H12; ABS)

In this workflow, fluorescence intensity is measured only in the wells A1-H6, followed by an absorbance measurement for the wells A7-H12.

## Cuvette Strip

This strip is used to define a measurement in a cuvette that is inserted into the cuvette port of the instrument.

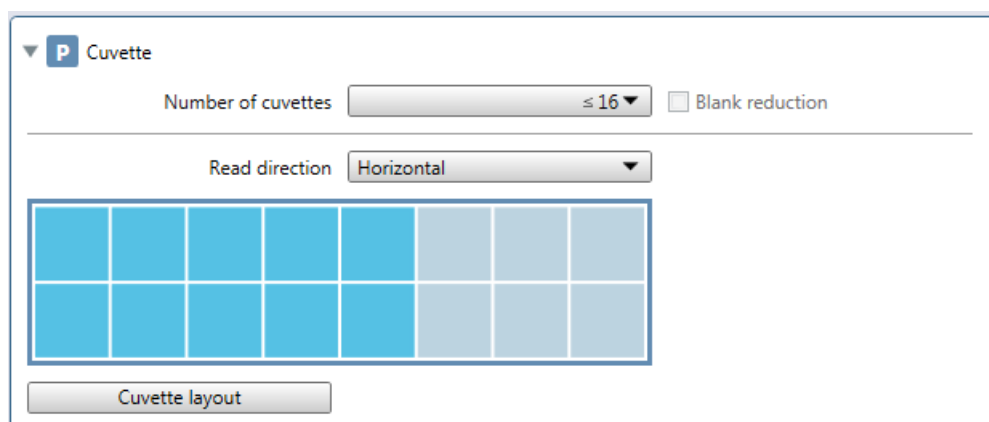

Figure 8: Cuvette strip

The **Cuvette strip** contains the following elements:

<b>Number of cuvettes</b>	Select the maximum possible number of cuvettes. Define the exact number of cuvettes used for the measurement by selecting the corresponding cuvettes within the cuvette holder displayed.
<b>Blank reduction</b>	Select <b>Blank reduction</b> to perform the automatic blank correction for all measured values. The Blank reduction is selectable only if the cuvette layout contains at least one cuvette defined as Blank (BL).
<b>Read direction</b>	Define the direction for the consecutive cuvette reading and the corresponding prompting with respect to the definition on the cuvette holder: <ul style="list-style-type: none"> <li>• <b>Horizontal</b> (i.e. horizontal order)</li> <li>• <b>Vertical</b> (i.e. vertical order)</li> </ul>
<b>Cuvette layout</b>	Please refer to <b>Plate Strip/Defining the Plate Layout</b>



**NOTE:** When working with the Tecan cuvette adapter, select the corresponding plate definition file within the Plate strip and define a measurement.

## Well Strip

Use the **Well** strip to perform measurements well by well. Without this strip, all measurement steps are done plate-wise.

## 8.6.2 Detection

For detailed information on detection strips, see the corresponding chapter for the detection mode, e.g. 9.5.1 Luminescence Strip, 10.3.1 Alpha Technology, 11.6.1 Absorbance Strip, 12.11.1 Fluorescence Intensity Strip, etc.

## 8.6.3 Action

### Shaking Strip

Figure 9: Shaking strip

Use the **Shaking** strip to define the following parameters:

<b>Duration</b>	<p>Define <b>Time [sec]</b> for shaking.</p> <p><b>Continuous shaking</b> can be selected and used within a kinetic measurement with a fixed interval time. Only in that case is the option <b>Continuous shaking</b> enabled and available. Select it to perform shaking for the remaining time within consecutive cycles at any of the available positions.</p> <p>At position:</p> <ul style="list-style-type: none"> <li>• <b>Current</b></li> <li>• <b>Incubation</b></li> <li>• <b>Current with ventilation</b> (if removable lid or humidity cassette is selected)</li> <li>• <b>Incubation with ventilation</b> (if removable lid or humidity cassette is selected)</li> </ul>
<b>Mode</b>	<p>Linear, Orbital, Double orbital (humidity cassette not selected)</p> <p>Orbital, Double orbital (humidity cassette selected)</p>
<b>Amplitude [mm]</b>	<p>1-6 mm (humidity cassette not selected)</p> <p>2.5-6 mm (humidity cassette selected)</p>
<b>Frequency [rpm]</b>	<p>The number of revolutions per minute (rpm) is displayed.</p>
<b>Show ventilation settings</b>	<p>Select the <b>Interval time</b> for ventilation in minutes.</p> <p>Select the <b>Duration</b> of ventilation in seconds.</p>



## Wait Strip

This strip can be used to define a specific time period before the next step within a workflow is executed.

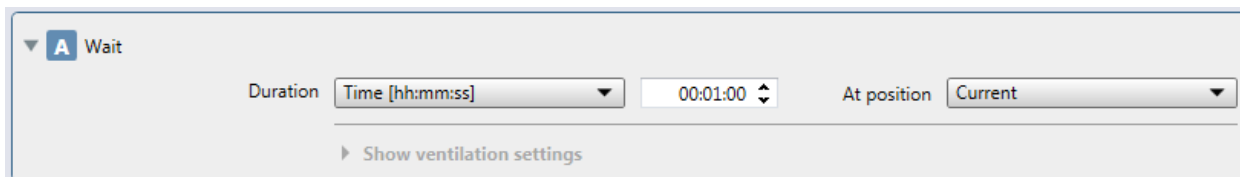

Figure 10: Wait strip

Use the **Wait** strip to define the following parameters:

<p><b>Duration</b></p>	<p>Define <b>Time [hh:mm:ss]</b> for waiting.</p> <p><b>Continuous waiting</b> can be selected and used within a kinetic measurement with a fixed interval time. Only in that case is the option <b>Continuous waiting</b> enabled and available. Select it to perform waiting for the remaining time within consecutive cycles at any of the available positions.</p> <p>At position:</p> <ul style="list-style-type: none"> <li>• <b>Current</b></li> <li>• <b>Incubation</b></li> <li>• <b>Current with ventilation</b> (if removable lid or humidity cassette is selected)</li> <li>• <b>Incubation with ventilation</b> (if removable lid or humidity cassette is selected)</li> </ul>
<p><b>Show ventilation settings</b></p>	<p>Select the <b>Interval time</b> for ventilation in minutes.</p> <p>Select the <b>Duration</b> of ventilation in seconds.</p>

## Injection Strip

For detailed information about the **Injection** strip, refer to 14.5.1 Injector Strip.

## Condition Strip

Use this strip to define measurements with conditions.

Figure 11: Condition strip

The **Condition** strip contains the following elements:

<b>Command</b>	<ul style="list-style-type: none"> <li>• <b>Start at cycle</b> to perform the conditional step at a defined cycle.</li> <li>• <b>Start at value</b> to execute the conditional step at a defined raw data value. Define the <b>Input data</b> (i.e. Label name the reference value refers to), <b>Reference well</b> and <b>Value</b> at which the conditional step should be started.</li> <li>• <b>Stop at value</b> to stop the conditional step at a defined raw data value. Define the <b>Input data</b> (i.e. Label name the reference value refers to), <b>Reference well</b> and <b>Value</b> at which the conditional step should be stopped.</li> </ul>
<b>Executed once</b>	Selected by default. If selected, the conditional step is executed only once.



**CAUTION:** When defining values with decimal places always use the decimal symbol as defined in the culture settings of the PC's operating system.

## Temperature Strip

For detailed information about the **Temperature** strip, refer to chapter 15.1.2 Temperature Control via Method.

## Gas Strip

For detailed information about the **Gas** strip, refer to chapter 15.3.6 Gas Control via Method.

## Move Plate Strip

Use the **Move Plate** strip to move the plate out or into the instrument within a workflow.

## User Intervention Strip

The **User Intervention** strip informs the operator of the instrument to execute a particular action during the workflow at a specific time. A message appears and the measurement process stops until **OK** is clicked.

## Comment Strip

Use the **Comment** strip to enter a remark or statement for the current measurement in the text field. This text is shown together with the measurement in the result output sheet. Comments have no impact on the measurement workflow.

## 8.6.4 Kinetic

### Kinetic Loop Strip

Use this strip to define kinetic measurements.

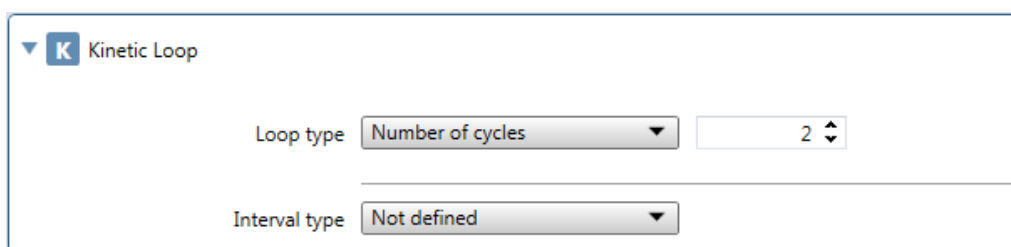

Figure 12: Kinetic Loop strip

The Kinetic Loop strip contains the following elements:

<b>Loop type</b>	Select <b>Number of cycles</b> and define a cycle value. Select <b>Duration [hh:mm:ss]</b> and define duration of the kinetic measurement.
<b>Interval type</b>	Select <b>Not defined</b> for measurements without a kinetic interval time, measurements are performed as fast as possible. Select <b>Fixed</b> for measurements with a kinetic interval time and define the interval time.



**NOTE:** To enable the options **Continuous shaking** and **Continuous waiting** define a kinetic measurement with a **Fixed** interval time.

## 8.7 Workflow Pane

The Workflow pane is the central window of the Method Editor, in which the workflow is visible and available for defining and editing measurement parameters.

There are two ways to insert a strip from the Control bar into the Workflow pane:

- Select a strip from the Control bar; double-click it to insert it into the Workflow pane directly after the previous strip.
- Click the strip in the Control bar and drag it into the Workflow pane to the respective position.

The strips are numbered according to their sequence. Once a strip has been inserted into the Workflow pane, the settings and parameters for this strip can be entered or edited.

Single strips inside the Workflow pane can be collapsed to display the most important information or expanded to access all editable functions. Click the expand button next to the title of the strip to switch between the two view modes.

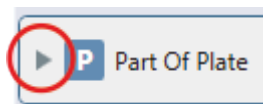

Figure 13: Expand button

By default, SparkControl starts with the Plate strip in the Workflow pane.

The currently selected strip within the Workflow pane is highlighted. If a strip contains an erroneous item, the item is highlighted in red and the strip number is colored red. If a strip is invalid within the current workflow, the whole strip is marked red. All errors are automatically displayed in the Info pane. If the workflow contains errors, the workflow can be neither saved nor started.

It is recommended to always save the workflow before starting a measurement.

### 8.7.1 Hierarchy of Strips

The hierarchy of strips in the Workflow pane is as follows:

1. Plate
2. Part of Plate (range)
3. Well

Any desired measurement step can be inserted directly after a **Plate**, **Part of Plate** or **Well** strip. Use the **Outdent** and **Indent** options in the Edit menu to modify the sequence of execution of the single strip component or select a strip in the Workflow pane, click the right mouse button and select **Outdent** or **Indent**.

## Indenting and Outdenting Strips

The decision to indent/outdent a measurement strip will modify the workflow of the instrument during measurements.

The actions of all strips with the same indentation are performed sequentially. The only dependence between these strips is that the next action starts directly after the previous action is finished.

▶ P Plate	Name GRE96ft	Plate area A1:H12	001	
▶ D Absorbance	Name Label 1	Measurement wavelength 492	002	
▶ D Absorbance Scan	Name Label 2	Measurement wavelength 200 - 1000	003	

Figure 14: A series of independent measurement steps

A strip that is indented more than the previous strip shows dependence between the two strips. This means that the parameters defined in the first strip are also active for the second (indented) strip.

The following is an example of how to define a multi-label kinetic measurement with an **Absorbance** and a **Luminescence** strip. In this example, both strips depend on the **Kinetic Loop** strip, which depends on the **Plate** strip.

The **Workflow** pane appears as follows:

▶ P Plate	Name GRE96ft	Plate area A1:H12	001		
▼ K Kinetic Loop	Loop type: <input type="text" value="Number of cycles"/> <input type="text" value="2"/>			002	
	Interval type: <input type="text" value="Not defined"/>				
▶ D Absorbance	Name Label 1	Measurement wavelength 492	003		
▶ D Luminescence	Name Label 2	Attenuation None	Integration time 1000	004	

The above definition results in the following workflow:

The **Absorbance** of all wells of a 96-well plate is measured first following by **Luminescence** measurements of all wells. Both measurements are performed in 2 kinetic cycles.

Outdenting the **Luminescence** strip to a level with a **Kinetic Loop** item changes the workflow. Select **Luminescence** and click the right mouse button. Select **Outdent** from the context sensitive menu.

The **Workflow** pane appears as follows:

▶ P Plate	Name GRE96ft	Plate area	
▶ K Kinetic Loop			
▶ D Absorbance	Name Label 1	Measurement wavelength 492	
▶ D Luminescence	Name Label 2	Attenuation None	Integration time 1000

In this workflow, an **Absorbance** kinetic measurement with 2 cycles is performed first. After this loop has finished, the **Luminescence** endpoint measurement starts.

## 8.7.2 Info Pane

The **Info** pane on the right side of the screen displays information that is relevant for the currently selected strip. Any warnings and errors are shown.

## 8.7.3 Measurement Types

### Plate-wise Measurements

Each detection strip is performed on all selected wells. Plate-wise measurements may contain a maximum of 25 independent detection strips that do not need to be of the same detection type.

### Well-wise Measurements

Each detection strip is performed in one well before continuing to the next well. Well-wise measurements may be composed of a maximum of five detection strips of the same type, e.g. five absorbance strips.



**NOTE:** Only measurement steps of the same detection mode are allowed within a Well strip (e.g. two absorbance steps with different wavelengths). Exception of that rule: multi-label kinetic measurements performed well-wise (e.g. Kinetic loop/Well/Absorbance/Fluorescence Intensity).



**NOTE:** Scan measurements are not allowed within a Well strip.



**NOTE:** The action strips Move plate and User intervention are not allowed within a Well strip.

### Endpoint Measurements

An endpoint measurement is a measurement executed only once without repetition. Endpoint measurements can be performed plate-wise and well-wise.

### Kinetic Measurements

A kinetic measurement consists of several consecutive measurements, which may be executed in certain intervals. Kinetic measurements can be performed plate-wise and well-wise.



**NOTE:** Fluorescence intensity 3D scan are not allowed within a kinetic measurement.



**NOTE:** The action strips Temperature and Gas are not allowed within a kinetic measurement loop.



**NOTE:** Users are advised to set up suitable methods prior to measurements and to use the same method for all similar kinetic measurements in order to obtain comparable results.

## Single-label Measurements

Single-label measurements are measurements with only one detection strip, e.g. with absorbance or fluorescence. Single-label measurements can be performed plate-wise and well-wise as endpoint or kinetic measurements.

## Multi-label Measurements

Multi-label measurements are measurements with multiple detection strips of the same or different consecutive detection modes, e.g. with multiple absorbance, fluorescence, luminescence labels or with mixed measurements. Multi-label measurements can be performed plate-wise and well-wise as endpoint or kinetic measurements.

## Conditional Measurements

### Time-triggered measurements:

Time-triggered conditional measurements are a group of the measurements in which a measurement or an action is executed or stopped at a certain cycle.

Example:

The screenshot displays two configuration panels. The top panel, labeled 'Condition' (ID 003), has a 'Command' dropdown set to 'Start at cycle', a numeric input field set to '3', and a checked checkbox for 'Executed once'. The bottom panel, labeled 'Shaking' (ID 004), has 'Duration' set to 'Time [sec]' with a value of '5', 'At position' set to 'Current', 'Mode' set to 'Linear', 'Amplitude [mm]' set to '1', and 'Frequency [rpm]' set to '240'. A 'Show ventilation settings' link is visible at the bottom of the Shaking panel.

If **3** is entered for **Command: Start at cycle** within a kinetic measurement containing, e.g. a **Shake** step, shaking is performed only at cycle 3, if **Executed once** is selected.



**NOTE:** Kinetic conditions such as **Shake** and **Inject** should be inserted right after a **Kinetic Loop** strip in order to ensure optimal result reproducibility.

## Signal-triggered Measurements:

Signal-triggered conditional measurements are measurements in which a measurement or an action is triggered by a measured value while running a method. The method steps can be started or stopped after the pre-defined reference value for a specific detection label has been reached.



**CAUTION:** When defining values with decimal places always use the decimal symbol as defined in the culture settings of the PC's operating system.

Examples:

### 1. Kinetic fluorescence measurement:

The screenshot displays the software interface for configuring a kinetic fluorescence measurement. It is organized into three main sections:

- Plate (001):** Name: GRE96ft, Plate area: A1.H12.
- Absorbance (002):**
  - Name: Label 1
  - Measurement wavelength [nm]: 600
  - Reference:
  - Bandwidth: 3.5
  - Button: Show advanced settings
- Condition (003):**
  - Command: Start at value
  - Executed once:
  - Input data: Label 1
  - Reference well: A1
  - Value: > 2
- Fluorescence Intensity (004):**
  - Name: Label 2
  - Mode:  Top,  Bottom
  - Fluorophore: Other
  - Excitation wavelength [nm]: Monochromator, 485
  - Excitation Bandwidth: 20
  - Emission wavelength [nm]: Monochromator, 535
  - Emission Bandwidth: 20
  - Button: Show advanced settings

Absorbance is measured at 600 nm. A fluorescence measurement is executed only if an OD value > 2 has been detected in a pre-defined reference well.



## 2. Kinetic multi-label measurement:

A kinetic multi-label measurement with absorbance and fluorescence as labels; the absorbance is measured as long as the reference well reaches an OD value of 2.5 OD. After that, the absorbance measurement is stopped and the method proceeds with the execution of the fluorescence label.

### 8.7.4 Multiple Reads per Well

The multiple reads per well option (MRW) is available for absorbance, fluorescence top and bottom fixed wavelength measurements in order to achieve maximum well illumination. The function is not available for scan measurements. This option is especially applicable for cell based assays, since the distribution of the cells in the well is often not homogenous.



**NOTE:** The feature **Multiple Reads per Well** is not available for well-wise measurements.



**NOTE:** The reference wavelength in the **Absorbance** strip is not selectable in combination with **Multiple Reads per Well**.

When working with multiple reads per well, select one of the following options:

## User Defined

Select a MRW pattern type to be used for the measurement. The following MRW types can be selected:

- Square
- Square (filled)
- Circle
- Circle (filled)
- X-Line
- Y-Line
- XY-Line

Select the MRW size that defines the number of measurement points per well. The size values available depend on the plate format used.

## Area Scan

The **Area scan** is a high density option of MRW and enables enhanced signal resolution within a measured well. Select one of the following sizes: 20x20, 30x30, 40x40, 50x50, 60x60, 70x70, 80x80, 90x90 and 100x100.



**NOTE:** It is recommended to perform area scan measurements with one flash.

## Optimal Read

The Optimal Read is available only for fluorescence intensity bottom measurements. Similar to the MRW read mode, multiple, spatially separated spots inside the well are measured. The spots are arrayed to cover the whole well area in order to achieve maximum well illumination. The total number of individual measurement spots per well is reflected by the size of the Fluorescence Intensity Bottom fiber and is optimized for plate formats from 12 to 96 wells (see table below). 384-well plates are optimally illuminated by a single-spot read.

Plate format	Size	Number of spots
96 wells	3x3	5
48 wells	5x5	21
24 wells	7x7	37
12 wells	9x9	61

Table: Optimal Read spot patterns in different plate formats. Pattern used: Circle (filled)

Changing the total number of flashes per well (1-100) will result in the automatic adjustment of the number of flashes per spot, giving the user the possibility to obtain representative results in each well.

The total number of flashes is automatically distributed over all measured spots. A minor imprecision occurs if an entered flash number is not divisible by the default number of spots for the used plate format. In this case, the next possible flash distribution that is divisible by the number of spots per well is calculated, e.g. a measurement with a total of 26-30 flashes in a 96-well plate is performed with 6 flashes per spot, whereas a total flash number of 31 results in 7 flashes per spot.

## 8.8 Dashboard

### 8.8.1 Structure

The Dashboard of the SparkControl software is used for

- Communicating with connected instruments
- Starting measurements
- Monitoring measurement progress

The Dashboard is designed to work with a touchscreen. Fingers can be used for interaction.

The Dashboard contains the following structural elements:

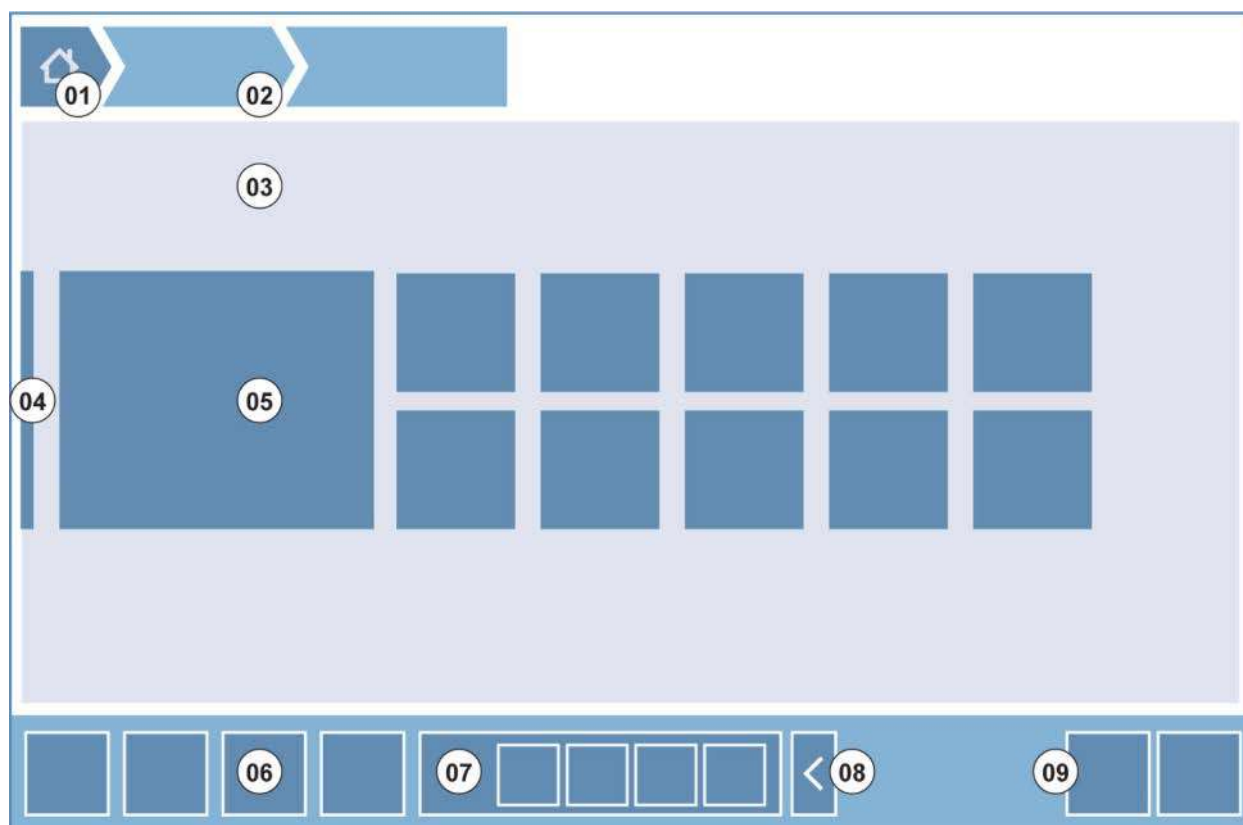

Figure 15: Structural elements of the Dashboard

- 01 Home button
- 02 Breadcrumbs
- 03 Workflow pane
- 04 Navigation bar
- 05 Tiles
- 06 Action bar with action buttons
- 07 Expandable action button
- 08 Expand button (to show more action buttons)
- 09 Action buttons (OK, Cancel, Stop)

#### Tiles

Tiles start user selected process steps, e.g. a 'Method' tile starts the selected method.

The clickable surface is always the whole tile area with the exception of tiles with multi-functionality.

For the multi-functional tiles, the clickable surface is always darker than the background color. Example: Start tile (refer to chapter 8.8.5 Starting a Method).

## Action Buttons

A group of buttons designed for

- Editing of method and instrument settings
- Confirmation/cancellation/stopping of workflow steps (OK/Cancel/Stop button)
- Searching/Alignment of listed elements

## Expandable Action Buttons

Expandable action buttons are used for a group of action buttons that refers to the same action group (e.g. Filter, Injector).

Tap an expandable action button to reveal all action buttons for the corresponding group.

Example: The action group Injector contains the sub-action buttons Prime, Backflush and Rinse.



## Expand Buttons

Expand button are used for expanding/collapsing of grouped elements.

## Action Bar

The action bar is the Dashboard area with action buttons.

## Navigation Bar

The expandable Navigation bar on the left side of the Dashboard is used to switch to other SparkControl components (e.g. Method Editor).

## Breadcrumbs / Navigation history

Breadcrumbs are used as guides within the different application levels and are placed on the top of the screen. They track the navigation history of the previous windows and include a home button. Select the home button to return to the Dashboard window.

Example:



i.e. a method called ELISA has been selected first, following by opening the Temperature Control window in order to change/prove the temperature before measurement start.

## 8.8.2 Software Navigation

### Application Levels

The levels are based on a hierarchical navigation system with a maximum of three different application levels.

- The **first application level** is the entry point of each application in the dashboard, e.g. instrument settings, start a measurement run or monitor the measurement process.
- The **second application level** is displayed whenever the selection on the first level requires further user interaction, e.g. final user confirmation in order to start a method.
- The **third application level** reveals the details for a selected element in the second level, e.g. defining filters of the excitation filter slide.

### Switching Levels

Breadcrumbs	<p>The breadcrumbs include an integrated close and cancel button (x) for each application level displayed. Select this button to close the current application level and to return to the next higher level.</p> <p>Closing the application level via the breadcrumb navigation automatically discards all changes made within the respective application level.</p>
OK and Cancel	<p>Select <b>OK</b> to confirm all changes, select <b>Cancel</b> to discard the changes. Both selections automatically close the respective application level.</p>

### 8.8.3 The Dashboard

The **Dashboard** window contains the following tiles:

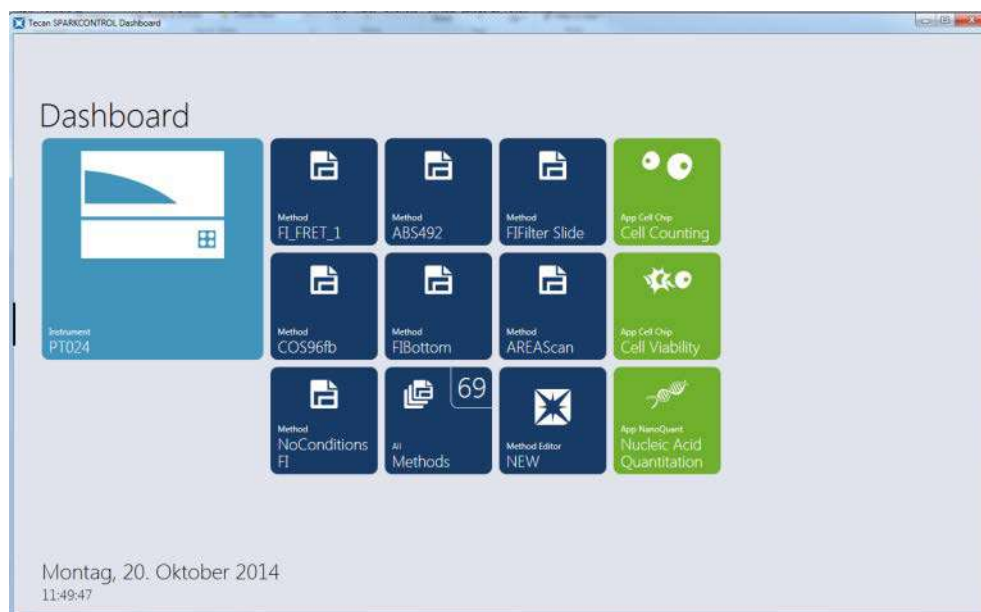

Figure 16: Instrument tiles, Method tiles and App tiles in Dashboard

Instrument	Light blue instrument tiles stand for connected instruments. Select an instrument tile to access the Instrument Control window.
Method	<p>Dark blue method tiles stand for methods valid for the connected instrument. Select a method tile to start the method.</p> <p>The maximum number of method tiles is limited to eight. If more than eight methods are available, use the <b>All methods</b> tile to open the list of all methods. The group of method tiles displayed is built up dynamically according to the following rules:</p> <ul style="list-style-type: none"> <li>• Every new defined or every modified method is automatically displayed in dashboard and placed on the top of the group.</li> <li>• Every executed method is displayed automatically in the Dashboard and placed on the top of the group.</li> <li>• All other method tiles are moved accordingly. In case of more than eight available methods, the previously last method of the group is removed from dashboard.</li> </ul> <p>Select <b>NEW</b> to switch directly to Method Editor in order to define a new method.</p>
App	Light green App tiles stand for apps provided by Tecan. Select an <b>App tile</b> to start the corresponding app.

To switch to **Method Editor**, **Settings** or **Screencasts** use the expandable Navigation bar on the left side of the Dashboard start window. Select **Shut down** to close the SparkControl application.

## 8.8.4 Instrument Control

The **Instrument Control** window can be opened by tapping an instrument tile. It provides the user interface for the direct communication to the instrument (e.g. injector maintenance, filter definition).

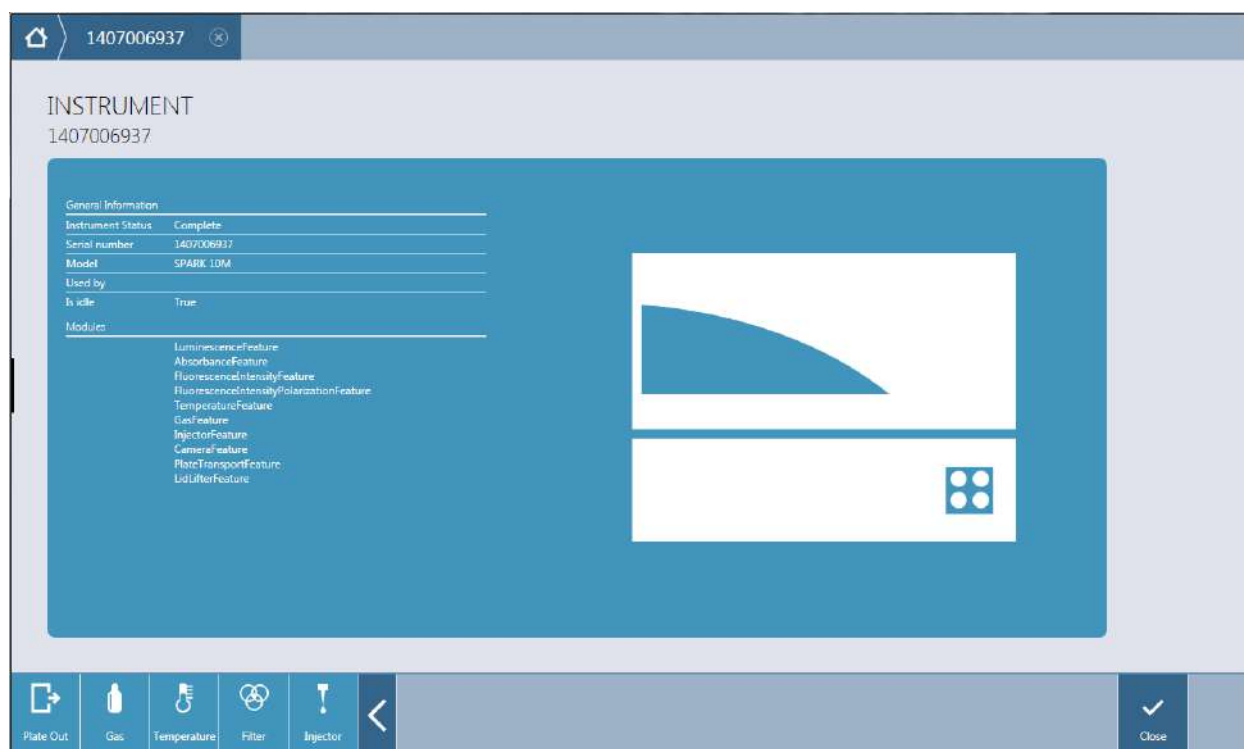

Figure 17: Instrument Control window



**NOTE:** The availability of action buttons depends on the instrument configuration.

The window contains the following action buttons:

<b>Plate In/Out</b>	Select <b>Plate In</b> to move the plate carrier into the instrument. Select <b>Plate Out</b> to move the plate carrier out of the instrument.
<b>Gas</b>	Select <b>Gas</b> to open the Gas Control window.
<b>Temperature</b>	Select <b>Temperature</b> to open the Temperature Control window.
<b>Filter</b>	Select <b>Excitation</b> to open the Filter Definition window for the excitation filter slide. Select <b>Emission</b> to open the Filter Definition window for the emission filter slide.
<b>Mirror</b>	Select <b>Mirror</b> to open the Mirror Definition window.
<b>Injector</b>	Select <b>Prime</b> to open the Injector window for priming. Select <b>Rinse</b> to open the Injector window for rinsing. Select <b>Backflush</b> to open the Injector window for backflushing.

## Multiple Instruments



**NOTE:** The SparkControl supports the connection of a maximum of 4 instruments. However, working in parallel is not possible. Only one instrument can be used at a time.

Each connected instrument is represented by a corresponding tile. The largest instrument tile represents the working instrument, i.e. the instrument that can be currently used for measurements.

To switch working instruments, select the instrument tile and close the Instrument Control window by clicking **OK**.

### 8.8.5 Starting a Method

After selecting a method, the **Check-and-Go** window is opened.



**NOTE:** A method can be selected from the Dashboard start window or from the list of all methods via the **All Methods** tile.

The **Check-and-Go** window contains the following tiles and buttons:

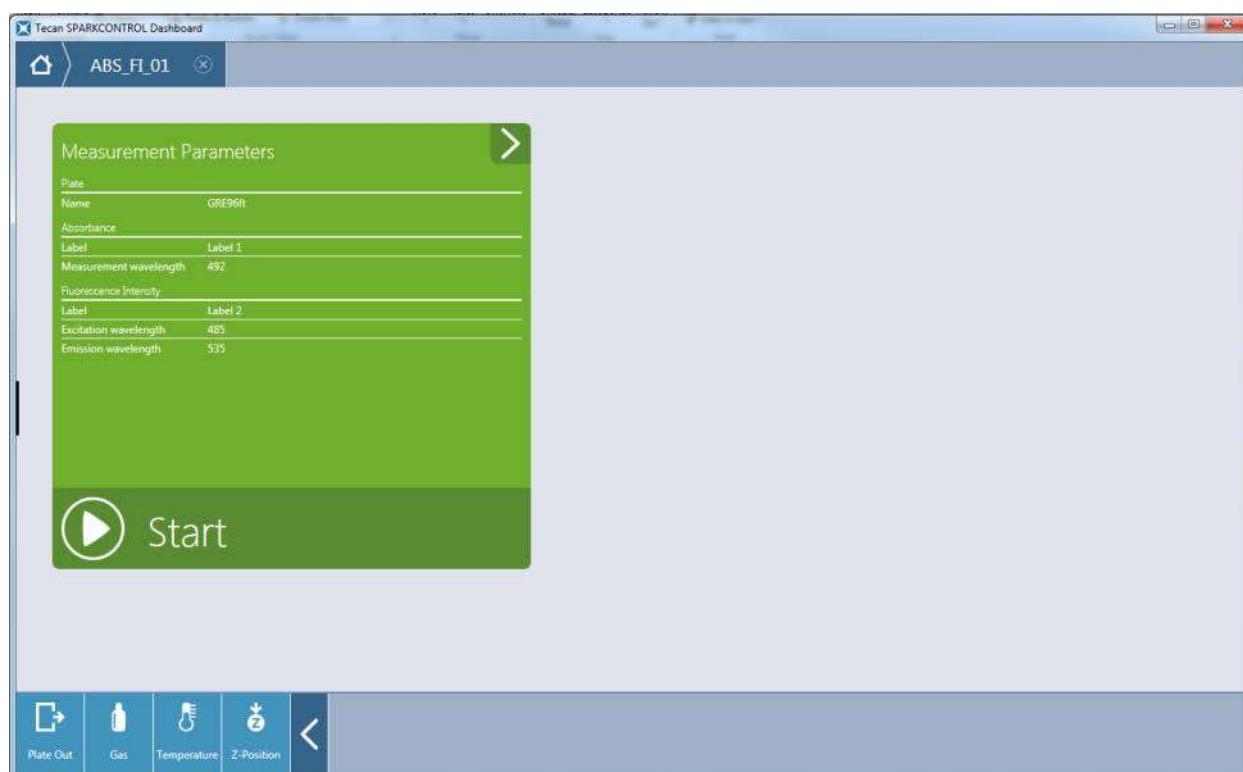

Figure 18: Check & Go window



**NOTE:** The availability of action buttons depends on the instrument configuration and method definition.



<b>Start</b>	The Start tile is a multi-functional tile. Select the expand button top right to view detailed information about the selected method (e.g. plate area, plate layout). Select <b>Start</b> to start the method.
<b>Plate In/Out</b>	Select <b>Plate In</b> / <b>Plate Out</b> to move the plate carrier into or out of the instrument.
<b>Gas</b>	Opens the Gas Control window.
<b>Temperature</b>	Opens the Temperature Control window.
<b>Filter</b>	Select <b>Excitation</b> / <b>Emission</b> to define the corresponding filters.
<b>Mirror</b>	Opens the Mirror Definition window.
<b>Injector</b>	Select <b>Prime</b> / <b>Rinse</b> / <b>Backflush</b> to open the Injector window to adjust the corresponding settings.
<b>Z-Position</b>	Select to perform Z-position optimization prior to measurement start.



**NOTE:** Changing the temperature or gas settings prior to measurement will not overwrite the temperature or gas settings defined in a method.

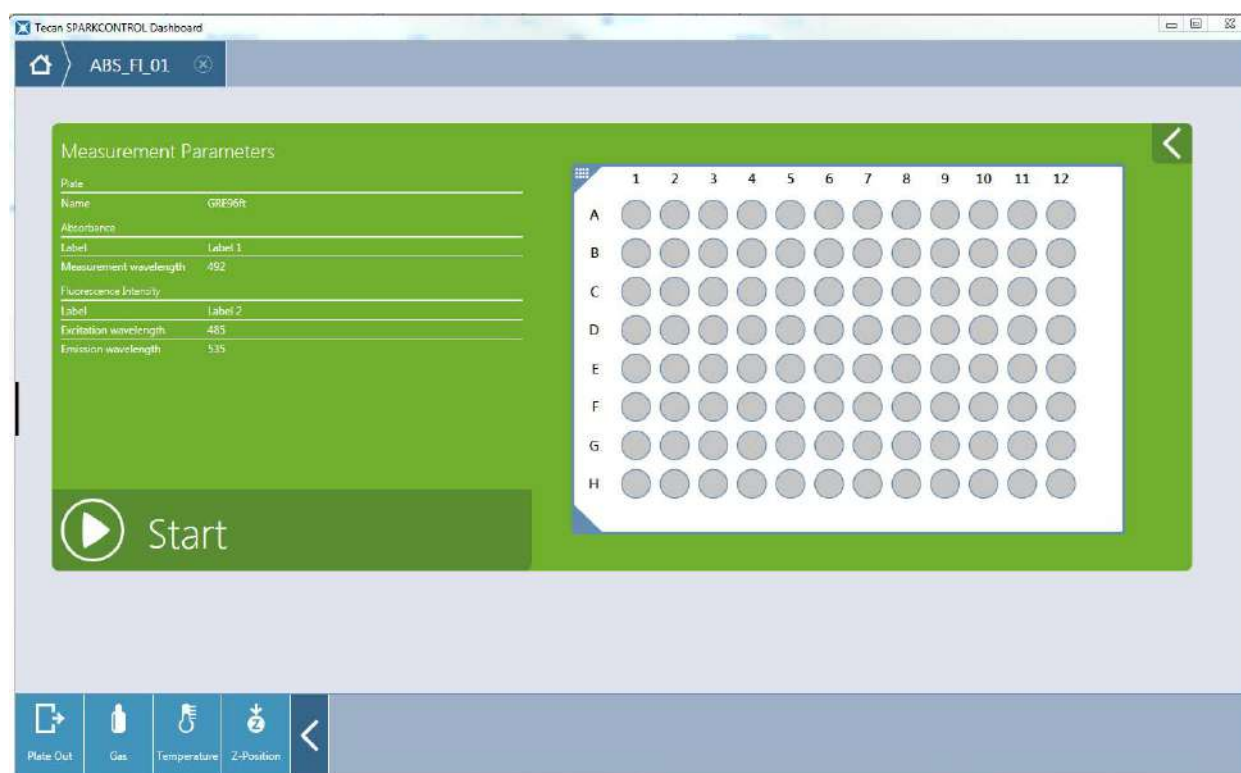

Figure 19: Expanded Check & Go window

## 8.8.6 Measurement Progress

Starting a measurement run opens the **Measurement Progress** window with the following elements:

<b>Data</b>	Data is selected by default. The incoming raw data from the instrument is monitored. For detailed information about the data display, refer to chapter 8.8.7 Data Display.
<b>Data as Colors</b>	Raw data values are correlated to colors and displayed as such in the plate.
<b>Monitor</b>	Monitor temperature and gas distribution during a measurement run.
<b>Stop</b>	Interrupt the current measurement run. The data acquired prior to measurement stop are automatically saved.
<b>Plate Out/In</b>	Disabled during a measurement run. The button becomes enabled after the measurement has been finished or while pausing a kinetic run.
<b>Pause/Continue</b>	Available for plate-wise kinetic measurements only. Select <b>Pause</b> to interrupt the measurement and subsequently <b>Continue</b> to proceed with the measurement.

## 8.8.7 Data Display

Measured data are displayed in two different views: the **Plate** view and the **Graph** view. The following chapters describe the general rules for data display depending on the measurement mode. Scan measurements and Images are excluded from the general rules and described separately (refer to 8.8.8 Scans and 8.8.9 Images).

### Single-label Endpoint Measurements

**Plate View:** Includes all measured data. Only single well selection is possible. After the measurement the value of the selected well is displayed in the information header at the top of the screen.

**Graph View:** Includes all measured data. The well selected in the Plate view is highlighted.

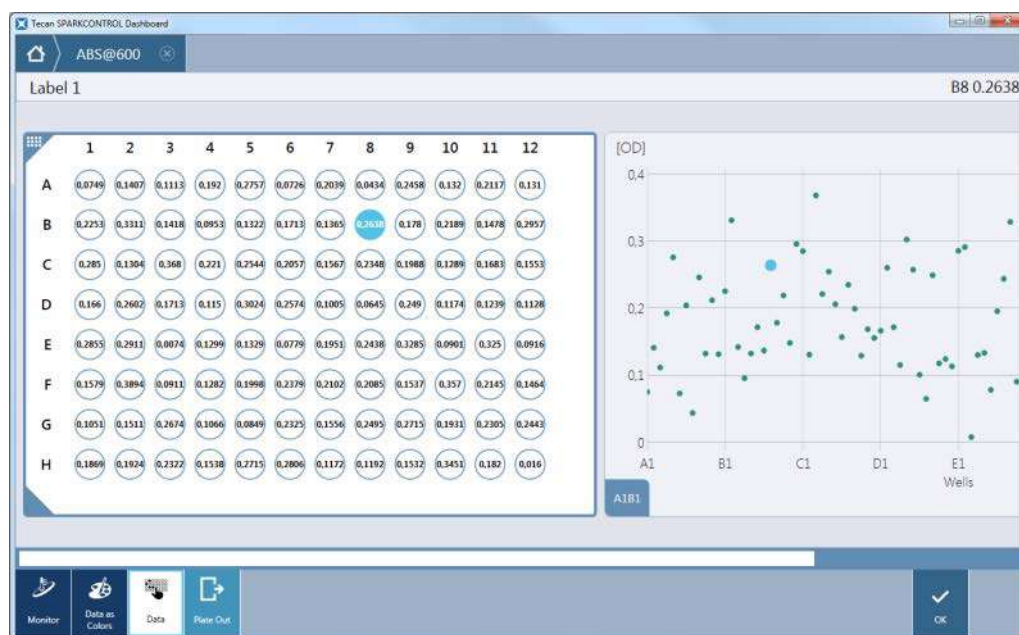

Figure 20: Monitoring a single-label endpoint measurement

## Single-label Kinetic Measurements

**Plate View:** Includes measured data of the last measured kinetic cycle. Multi well selection is possible. After the measurement the last cycle value of the selected wells is displayed in the information header at the top of the screen.

**Graph View:** Includes kinetic curves for the last ten wells selected in the Plate view. Fade in and out the single curves by selecting/deselecting the corresponding check boxes.

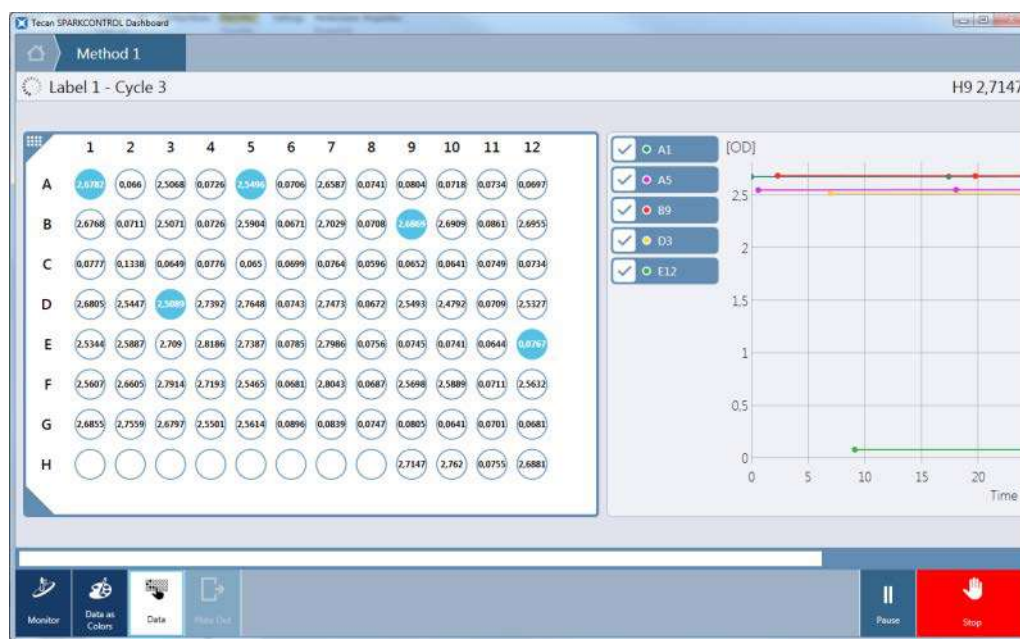

Figure 21: Monitoring a single-label kinetic measurement

## Multi-label Endpoint Measurements

**Plate View:** Includes measured data for all labels available. Move between the labels by applying the > and < controls placed below the plate. Only single well selection is possible. After the measurement, the value of the corresponding label for the selected well is displayed in the information header at the top of the screen.

**Graph View:** Includes all measured data for the selected well. It is possible to move to any of adjacent wells by tapping the corresponding **well control** placed left, right, top and bottom of the graphic display. Fade in and out the single-labels by selecting/deselecting the corresponding check boxes.

## Multi-label Kinetic Measurements

**Plate View:** Includes measured data of the last measured kinetic cycle for all labels available. Move between the labels by applying the > and < controls placed below the plate. Only single well selection is possible. After the measurement, the last cycle value of the corresponding label for the selected well is displayed in the information header at the top of the screen.

**Graph View:** Includes kinetic curves for all labels of the selected well in the Plate view. It is possible to move to any of adjacent wells by tapping the corresponding **well control** placed left, right, top and bottom of the graphic display. Fade in and out the single curves by selecting/deselecting the corresponding check boxes.

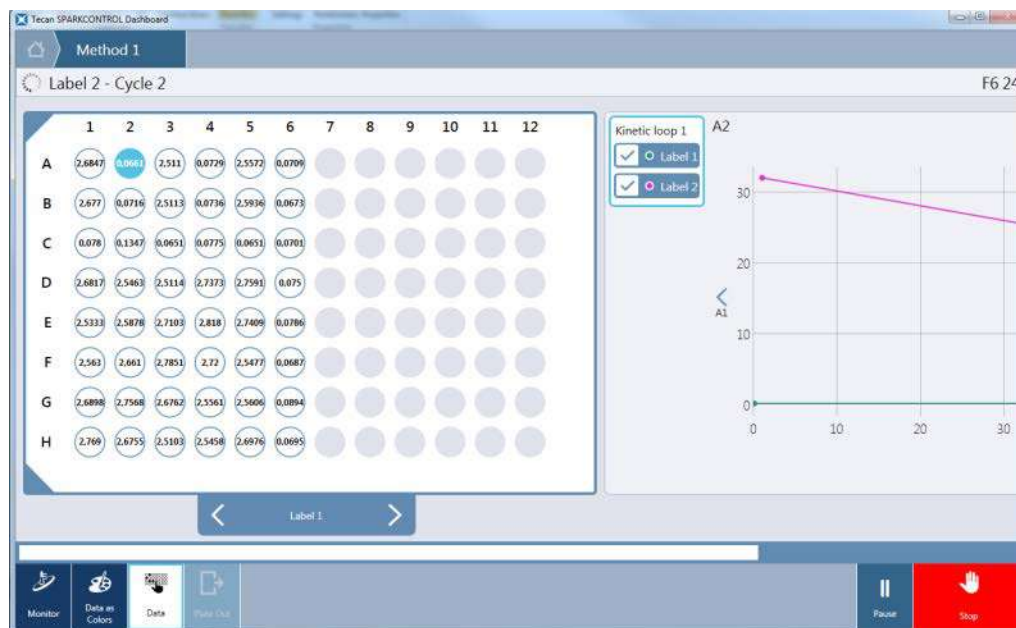

Figure 22: Multi-label kinetic measurement

## 8.8.8 Scans

### Single-label Endpoint Measurements

**Plate View:** Measured data are indicated by an **S**. Multi-well selection possible. Exception of that rule: 3D scans support only single well selection.

**Graph View:** Includes scans for the last ten wells selected in the Plate view. Fade in and out the single scans by selecting/deselecting the corresponding check boxes.

### Multi-label Endpoint Measurements

**Plate View:** Measured data are indicated by **S**. Only single well selection possible.

**Graph View:** Scans are displayed separately, not in parallel with other measured data. Select a scan tile for its display. It is possible to move to any of adjacent wells by tapping the corresponding **well control** placed left, right, top and bottom of the graphic display.

### Single-label Kinetic Measurements

**Plate View:** Measured data are indicated by **S**. Multi well selection possible.

**Graph View:** Includes scans for the last ten wells selected in the Plate view according to the kinetic cycle selected. Use the **+** and **-** controls included in the graphic to change the kinetic cycle number. Fade in and out the single curves by selecting/deselecting the corresponding check boxes.

### Multi-label Kinetic Measurements

**Plate View:** Measured data are indicated by **S**. Only single well selection possible.

**Graph View:** Scans are displayed separately, not in parallel with other measured data. Select a scan tile for its display. It is possible to move to any of adjacent wells by tapping the corresponding **well control** placed left, right, top and bottom of the graphic display. Use the **+** and **-** controls included in the graphic to change the kinetic cycle number.

## 3D Scan

**Plate View:** Measured data are indicated by **S**. Only single well selection is possible.

**Graph View:** Scans are always displayed separately, not in parallel with other measured data if available. Select a scan tile for its display. It is possible to move to any of adjacent wells by tapping the corresponding **well control** placed left, right, top and bottom of the graphic display.

## 8.8.9 Images

### Single-label Endpoint Measurements

**Plate View:** Depending on the measurement type, cell concentration, cell viability or cell confluence values included. Only single well selection possible.

**Graph View:** Includes the image of the selected well.

### Multi-label Endpoint Measurements

**Plate View:** Depending on the measurement type, cell concentration, cell viability or cell confluence values included. Only single well selection possible.

**Graph View:** Images are displayed separately, not in parallel with other measured data. Select an image tile for its display. It is possible to move to any of adjacent wells by tapping the corresponding **well control** placed left, right, top and bottom of the graphic display.

### Single-label Kinetic Measurements

**Plate View:** Cell confluence values for the last kinetic cycle included. Only single well selection possible.

**Graph View:** Includes the image of the selected well. It is possible to move to any of adjacent wells by tapping the corresponding **well control** placed left, right, top and bottom of the graphic display. Use the **+** and **-** controls included in the graphic to change the kinetic cycle number.

### Multi-label Kinetic Measurements

**Plate View:** Cell confluence values for the last kinetic cycle included. Only single well selection possible.

**Graph View:** Images are displayed separately, not in parallel with other measured data. Select a image tile for its display. It is possible to move to any of adjacent wells by tapping the corresponding **well control** placed left, right, top and bottom of the graphic display. Use the **+** and **-** controls included in the graphic to change the kinetic cycle number.

## 8.9 Starting a Method

### 8.9.1 Method Editor

A method can be started directly from the Method Editor by clicking the **Start** button. After starting a method, the software will switch to Dashboard view.

### 8.9.2 Dashboard

A method can be started directly from the Dashboard by selecting the corresponding **Method** tile. See chapter 8.8.5 Starting a Method.

### 8.9.3 Onboard-Start

A method can be started directly by pressing the **Onboard-Start** button on the instrument.

Define a method for the Onboard-Start as follows:

- Define a method and save it
- Select **Onboard-Start** via File menu of the Method Editor

Or

- Open a method
- Select **Onboard-Start** via File menu of the Method Editor

For watching the measurement progress of a measurement started via the Onboard-Start button, open the Dashboard and select the instrument tile of the working instrument.

## 8.10 Measurement Results

The export mechanism writes files according to the Office Open XML file format (xlsx). The results are saved automatically and can be found under C:\Users\Public\Documents\Tecan\SparkControl\Export\xlsx (default path) or under the path defined by the user.



**NOTE:** If the software can't write the results into a user-defined path, the results will be saved under C:\Users\Public\Documents\Tecan\SparkControl\Export\xlsx\AUTOSAVE.

Dependent on Result presentation settings (refer to chapter 8.12.3 Data Handling), the results can be opened automatically after the measurement run in Excel.

## 8.11 Method File Explorer

The Method File Explorer includes a list of all available methods files. The Method File Explorer can be accessed via the Method Editor.

## 8.12 SparkControl Settings

### 8.12.1 Structure

The **Settings** component is designed to allow the user the customization of the system default settings. These settings can be modified for

- Software
- Instrument
- Data Handling
- Plate Geometry
- Images

by selecting the corresponding program tile.

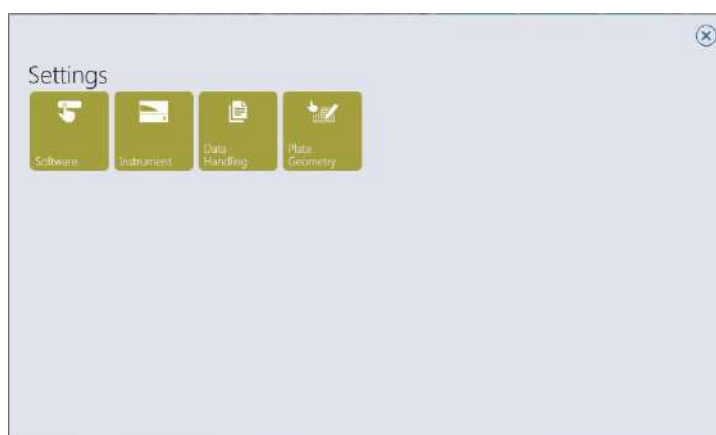

Figure 23: Settings window

The **Settings** component is optimized for working with touch using program tiles, tabs and buttons (refer to 8.8 Dashboard).

### 8.12.2 Instrument

The following settings per connected instrument can be modified:

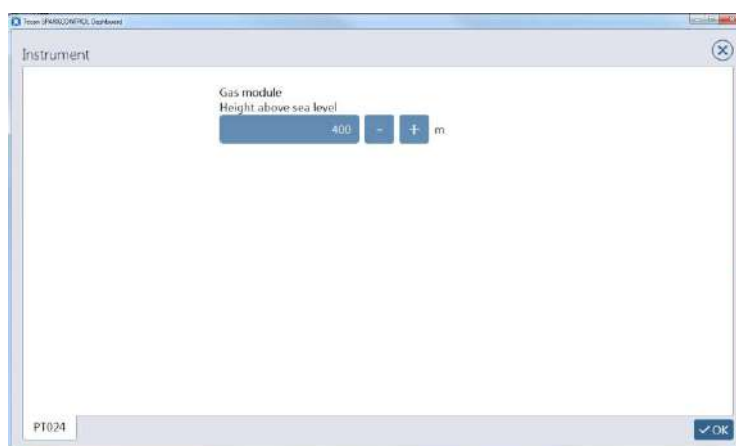

Figure 24: Instrument settings

Gas module	Available only for instruments with the gas module. Enter the height above sea level.
------------	---



**CAUTION:** Before the first use of the gas module, enter the height above sea level.

### 8.12.3 Data Handling

#### Default Export to Excel

This window determines the output settings of the measured results in Excel.

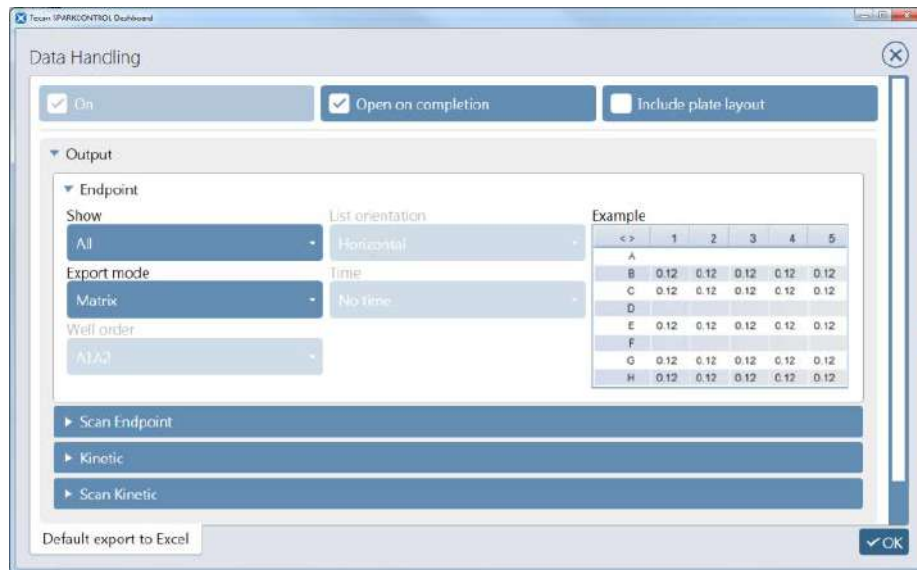

Figure 25: Data Handling window

#### Open on completion

If selected, the result sheet is opened in Excel after a SparkControl method is performed. This option is combinable only with the selection **New workbook**.

#### Include plate layout

If selected, the plate layout is included in the result sheet.

#### Path

Define the export path for the measurement data.

Default settings: C:\Users\Public\Documents\Tecan\SparkControl\Export\xlsx



**NOTE:** If the defined export path can't be accessed by the software, the results will be exported to C:\Users\Public\Documents\Tecan\SparkControl\Export\xlsx\AUTOSAVE.



**NOTE:** When Method Editor or Dashboard is not present at the time that the data export runs (i.e. software closed) and the method is started via the **Onboard-Start** button, the Excel file is saved under C:\Users\Public\Documents\Tecan\SparkControl\Export\xlsx. The option **Existing workbook** will be ignored and treated as the option **New workbook**.



## Destination

For result presentation, select one of the following destinations:

New workbook	If <b>New workbook</b> is selected, a new workbook is generated every time a measurement script is performed.
New worksheet	If <b>New worksheet</b> is selected, results are written into a new worksheet that is added to the workbook automatically generated by SparkControl after the first measurement. A new workbook is generated daily. However, it is possible to generate another workbook by selecting <b>Create new</b> button, i.e. after its selection the software starts adding worksheets into a new workbook.
Existing workbook	If <b>Existing workbook</b> is selected, a new worksheet will be added into a pre-defined workbook (an Office Open XML file format (xlsx)). Select the workbook, the results shall be placed into.



**NOTE:** If the destination **New worksheet** or **Existing workbook** is selected, the corresponding workbook must not be opened at the time the export runs. Always close it before starting a measurement. Otherwise the corresponding workbook can't be accessed and the software will generate and export the data to a new one.

## Output Design

Measurement mode: Select between Endpoint, Endpoint scan, Kinetic and Kinetic scan.

Endpoint:

<b>Show</b>	Select between <b>All</b> and <b>Measured</b> . If <b>All</b> is selected, the whole plate geometry, including all possible rows and columns, is displayed. If <b>Measured</b> is selected, only the results of the measured wells are displayed.
<b>Export mode</b>	Select between <b>Matrix</b> and <b>List</b> . If <b>Matrix</b> is selected, the data alignment corresponds to the microplate.
<b>List orientation</b> (for export mode List only)	Select between <b>Horizontal</b> or <b>Vertical</b> . If <b>Vertical</b> is selected, the wells are aligned in a column (in the Excel sheet). If <b>Horizontal</b> is selected, the wells are displayed in a row (in the Excel sheet).
<b>Well order</b> (for export mode List only)	Select between <b>A1A2</b> or <b>A1B1</b> . If <b>A1A2</b> is selected, the results are arranged in rows (of the microplate). If <b>A1B1</b> is selected, the results are arranged in columns (of the microplate).
<b>Time</b> (for export mode List only)	Select between <b>No time</b> or <b>Time per well</b> . If <b>No Time</b> is selected, only the values are displayed. If <b>Time per well</b> is selected, a timespan for each value is displayed.

Endpoint scan:

<b>Well order</b> (for export mode List only)	Select between <b>A1A2</b> or <b>A1B1</b> . If <b>A1A2</b> is selected, the results are arranged in rows (of the microplate). If <b>A1B1</b> is selected, the results are arranged in columns (of the microplate).
<b>Time</b> (for export mode List only)	Select between <b>No time</b> or <b>Time per well</b> . If <b>No Time</b> is selected, only the values are displayed. If <b>Time per well</b> is selected, a timespan for each value is displayed.
<b>Scan charts</b>	If selected, the scan charts are included in the result sheet

#### Kinetic:

<b>Show</b>	Select between <b>All</b> and <b>Measured</b> . If <b>All</b> is selected, the whole plate geometry, including all possible rows and columns, is displayed. If <b>Measured</b> is selected, only the results of the measured wells are displayed.
<b>Export mode</b>	Select between <b>Matrix</b> and <b>List</b> . If <b>Matrix</b> is selected, the data alignment corresponds to the microplate.
<b>List orientation</b> (for export mode List only)	Select between <b>Horizontal</b> or <b>Vertical</b> . If <b>Vertical</b> is selected, the wells are aligned in a column (in the Excel sheet). If <b>Horizontal</b> is selected, the wells are displayed in a row (in the Excel sheet).
<b>Well order</b> (for export mode List only)	Select between <b>A1A2</b> or <b>A1B1</b> . If <b>A1A2</b> is selected, the results are arranged in rows (of the microplate). If <b>A1B1</b> is selected, the results are arranged in columns (of the microplate).
<b>Time</b> (for export mode List only)	Select between <b>Time per cycle</b> or <b>Time per well</b> . If <b>Time per cycle</b> is selected, a timespan per cycle is displayed. If <b>Time per well</b> is selected, a timespan for every well is displayed.

#### Kinetic scan:

<b>Well order</b> (for export mode List only)	Select between <b>A1A2</b> or <b>A1B1</b> . If <b>A1A2</b> is selected, the results are arranged in rows (of the microplate). If <b>A1B1</b> is selected, the results are arranged in columns (of the microplate).
<b>Cycle display</b>	Select between <b>Horizontal</b> or <b>Vertical</b> . If <b>Vertical</b> is selected, the cycles are displayed in a column (in the Excel sheet). If <b>Horizontal</b> is selected, the cycles are displayed in a row (in the Excel sheet).
<b>Time</b>	Select between <b>Time per cycle</b> or <b>Time per well</b> . If <b>Time per cycle</b> is selected, a timespan per cycle is displayed. If <b>Time per well</b> is selected, a timespan for every well is displayed.

### 8.12.4 Software

The following startup behavior for the SparkControl can be modified:

#### Method Editor

<b>Default plate</b>	Select the plate type to be shown as default in the plate strip when defining a new method.
----------------------	---

### 8.12.5 Plate Geometry Editor

SparkControl offers a wide selection of predefined plate definition files. Use Plate Geometry Editor to create plate definition files for not listed plates or to edit an existing plate definition file. Select an existing plate file and modify it according to the plate demands of your choice. After editing save the plate definition file under a different name.

#### General

Enter the information about the plate manufacturer, color and material.

## Plate

Enter the plate dimensions (e.g. number of rows, columns, length, size, height, etc.) including the bottom thickness and refractive index.

Plate Geometry / [GRE96fb\_chimney] - Greiner 96 Flat Black

Rows / Columns	Size [µm]	Top left well [µm]	Well-to-well spacing [µm]
Number of rows: 8	Length: 127760	Distance from top: 11240	X-Direction: 9000
Number of columns: 12	Width: 85480	Distance from left: 14380	Y-Direction: 9000
Height [µm]		Bottom	
Plate height: 14400	Height with lid: 17406	Bottom thickness [µm]: 0	
Height tolerance: 200	Skirt height: 2500	Refractive index: 1,5	

Buttons: General | Plate | Well | OK

Figure 26: Editing a plate definition file



**NOTE:** Measure with a caliper ruler or better use values from the plate design drawings, given by the plate manufacturer.



**CAUTION:** When you manually measure the plate height, be aware that any plate tolerances caused by the production process of the plate will not be covered.

## Well

Edit the well dimensions (form, size, depth, working volume, etc).



**NOTE:** Be careful with settings of µm and µl values.

## 8.12.6 Images

Use this window to modify the default settings for the export path and file format of acquired images in combination with the cell counting module.

### Path

Define the export path for the images. Make sure that the NETWORK SERVICE account has Full control or at least Special permission for the selected folder.

Default settings: C:\Users\Public\Documents\Tecan\SparkControl\Images.



**NOTE:** When defining a user defined path always make sure that the NETWORK SERVICE account has Full control or at least Special permission for the selected folder.



**NOTE:** If the defined export path can't be accessed by the software, the results will be exported to C:\Users\Public\Documents\Tecan\SparkControl\Images\AUTOSAVE.

### File format

Select jpg (compressed image file) or tiff (uncompressed image file).

## 8.13 Screencasts

The **Screencasts** component is designed to allow the user to view recorded example workflows for working with SparkControl.

For starting the display, select the corresponding record tile.

# 9 Luminescence

## 9.1 Basic Principles

Luminescence is the emission of light caused by processes other than heat. Chemiluminescence is the emission of light due to a chemical reaction. If a living organism is the light emitting source (e.g. fireflies, some deep-sea organisms), this process is called bioluminescence.

Luminescence-based assays are often used to measure the activity of enzyme-labeled compounds. Light emission results from a luminescence substrate being decomposed by enzymes, such as peroxidase, phosphatase, or luciferase. The luminescence signal is only considered to be proportional to the abundance of the enzyme-labeled compound when sufficient substrate is provided.



**NOTE:** Luminescence is often used as umbrella term for all non-thermal emission types, such as fluorescence, phosphorescence, bio- and chemi-luminescence, etc.

At Tecan, however, the term luminescence is only used for emission types occurring without excitation.

## 9.2 Measurement Techniques

### 9.2.1 Glow Luminescence

Glow type luminescence assays provide a stable luminescence signal for a long time. There are several luminescence substrates that ensure a stable light output even over hours.

### 9.2.2 Flash Luminescence

Flash luminescence assays provide a very short-lived luminescence signal that has to be measured during the dispensing of activating agent or after a short time delay. Due to the short-lived signal, use of injectors may be advantageous for these measurements.

### 9.2.3 Multicolor Luminescence

Certain assays use two or more emitting species, giving light of two or more different wavelength ranges at the same time. For these assays, discrimination of wavelength ranges during luminescence detection may be required. The enhanced luminescence module from Tecan is perfectly suitable for commercial application such as Chroma-Glo Luciferase assay system and BRET based applications.

For example, Chroma-Glo assays generate red and green luminescence from two types of luciferase within a single well upon the addition of a single substrate. This homogeneous dual-reporter gene assay permits each reporter to be measured independently by detecting two luminescence signals per well at two different wavelength ranges, i.e. red and green.

## 9.2.4 Luminescence Scan

A luminescence scan measures emission spectra of luminescent substances (luminophores). For example, emission spectra of new/mutated types of luciferase (e.g. new recombinants of renilla- and firefly-luciferase) can be recorded in order to determine their emission maxima. Furthermore, luminescence scans can be applied to study environmental influences such as pH, solvent, or buffer on the spectral behavior of luminescent systems.

Luminescence intensity scan data can be displayed either as corrected spectra or as technical (uncorrected) spectra. The luminescence intensity values depend on instrument measurement characteristics (spectral sensitivity, filter transmission) as well as the wavelength and therefore may distort the measured spectra. Calibration data is saved on the instrument and intensity value corrections of the raw data are performed by default (however, they can also be switched off in the software).

## 9.3 Standard Luminescence Module

The standard luminescence module enables the integral measurement of a luminescence signal, without distinguishing between emission wavelengths.

The standard luminescence module can be used with all microplate formats up to 384 wells.

### 9.3.1 Luminescence Optics

The standard luminescence module consists of the luminescence fiber [1], the filter wheel [2], and the detection unit [3] (see Figure 27).

The luminescence fiber guides the luminescence light from the sample to the detection unit, where it passes the filter wheel on its way to the detector. A single luminescence fiber covers all plate formats up to 384 wells.

The sensitivity of the detection system requires attenuation of high luminescence light levels. The attenuators, two neutral density filters (OD1 and OD2) installed on the filter wheel, can be moved into the light path via the software.

The z-drive of the plate transport [4] ensures the optimal distance between microplate and luminescence optics, in order to maximize the signal and to minimize cross-talk. The z-adjustment is performed automatically after the appropriate plate type is selected in the software (see chapter 4.1 Z-Position).

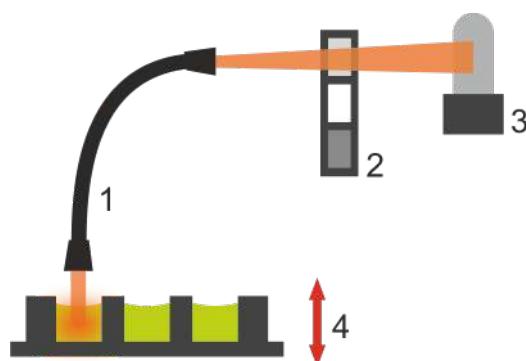

Figure 27: Optical system in standard luminescence module:  
 [1] luminescence fiber, [2] filter wheel,  
 [3] detection unit, [4] z-drive of plate transport

### 9.3.2 Standard Luminescence Detection

The standard luminescence module is equipped with a photon multiplier tube (PMT) which is operated in single photon counting mode. This technique is well-suited for the detection of small signals due to its low noise level. The photon-counting PMT provides a high dynamic range, which is ideal for luminescence measurements with a strong variation in luminescence intensity levels.

To achieve optimal performance, white plates are recommended for luminescence measurements.



**CAUTION:** Switch on the instrument at least 15 minutes before starting a luminescence measurement to ensure stable conditions for the measurement.

## 9.4 Enhanced Luminescence Module

The enhanced luminescence module has the ability of performing all available multicolor applications, as well as fast and high-sensitive luminescence scans. Additionally, it is able to measure luminescence signals without wavelength discrimination and to attenuate strong signals like the standard luminescence module.

The luminescence enhanced module can be used with all microplate formats supported by the instrument.

### 9.4.1 Luminescence Filters

The essential parts of the enhanced luminescence module are two sets of 19 spectral filters, built into two filter wheels. One filter wheel contains all the long pass filters; the other one contains the short pass filters.

A short pass filter transmits light of all wavelengths below the filter's cutoff wavelength. In contrast, a long pass filter transmits light of all wavelengths above the filter's cutoff wavelength. By combining short and long pass filters, arbitrary band pass filters can be realized allowing the spectral selection of the luminescence wavelengths to be detected.

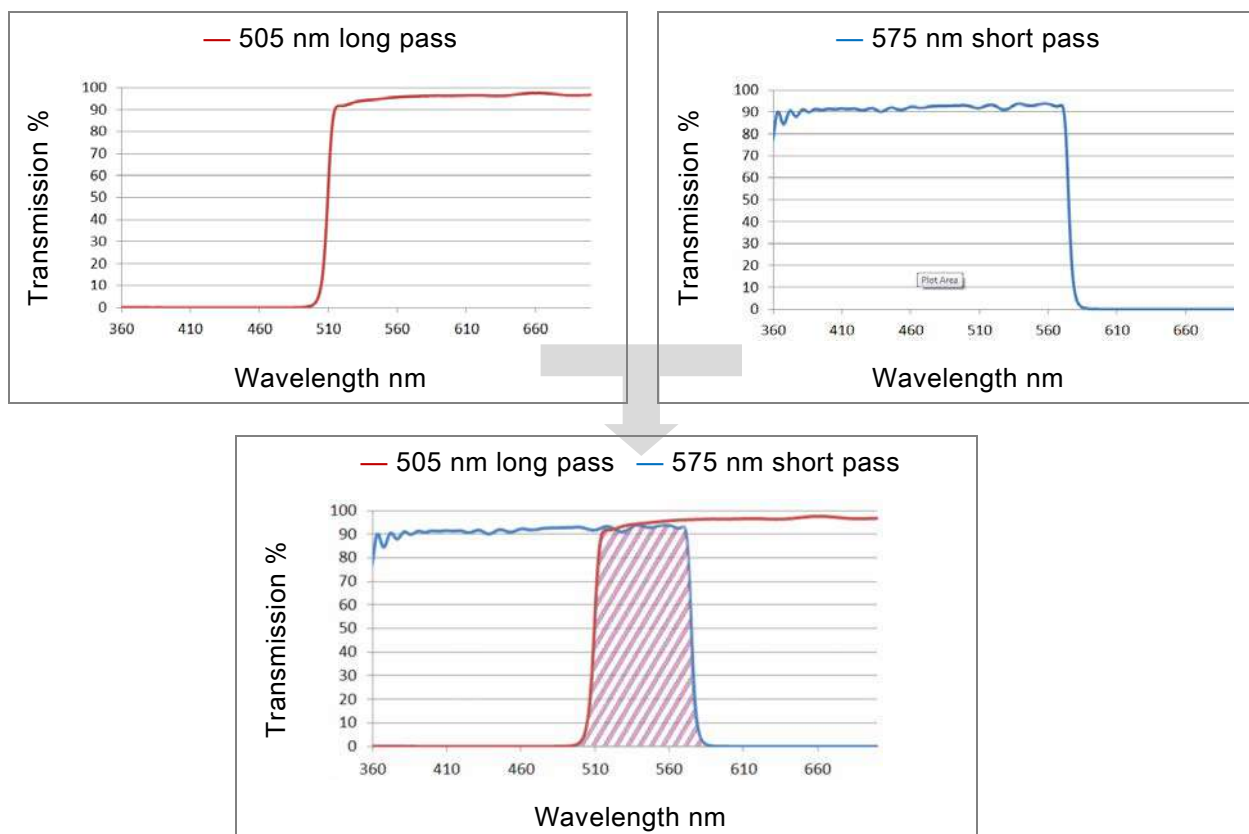

Figure 28: The combination of a 505 nm long pass filter with a 575 nm short pass filter yields a spectral measurement window for the luminescence emission from 505 to 575 nm.

Cutoff values of the short pass filters:

395, 410, 425, 440, 455, 470, 485, 500, 515, 530, 545, 560, 575, 590, 605, 620, 635, 650 and 665 nm.

Cutoff values of the long pass filters:

385, 400, 415, 430, 445, 460, 475, 490, 505, 520, 535, 550, 565, 580, 595, 610, 625, 640 and 655 nm.

The band pass filters formed by the combination of long and short pass filters are also used to perform luminescence scans. A complete wavelength scan (390 – 660 nm) consists of 18 measurement points, carried out by 18 dedicated filter pairs. The spectral bandwidth is fixed to 25 nm and the step size is fixed to 15 nm.

### 9.4.2 Enhanced Luminescence Optics

The enhanced luminescence module consists of the luminescence fiber [1], the aperture wheel [2], two filter wheels [3], and the detection unit [4] (see Figure 29).

The luminescence fiber guides the luminescence light from the sample to the detection unit, where it passes the long and short pass filter wheels on its way to the detector. The filter wheels are used for spectral discrimination of luminophores and suppression of unwanted luminescence wavelengths. The aperture wheel matches the light beam diameter to the microplate wells in order to prevent cross talk.

The enhanced luminescence module can be used for all plate formats up to 384 wells.

The sensitivity of the detection system requires attenuation of high luminescence light levels. The attenuators, two neutral density filters (OD1 and OD2) installed on the filter wheel, are moved into the



light path via the software. Combining OD1 and OD2 neutral density filters allows a light level attenuation of 1000x (corresponding to an OD3 filter).

The z-drive of the plate transport [5] ensures the optimal distance between microplate and luminescence optics, in order to maximize the signal and to minimize cross-talk. The z-adjustment is performed automatically after selecting the appropriate plate type in the software.

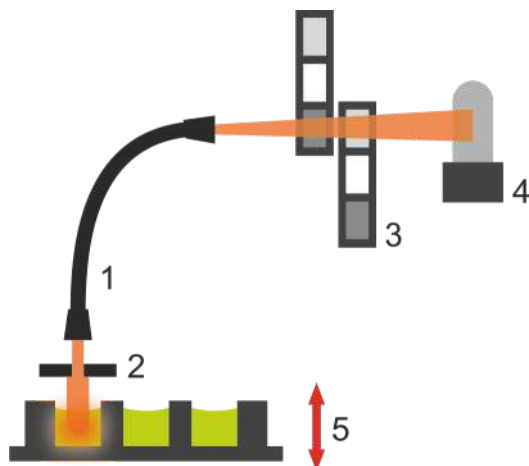

Figure 29: Optical system in luminescence enhanced module:  
 [1] luminescence fiber, [2] aperture wheel,  
 [3] two filter wheels, [4] detection unit, [5] z-drive of plate transport

### 9.4.3 Luminescence Detection

Please refer to chapter 9.3 Standard Luminescence Module.

## 9.5 Defining Luminescence Measurements

The software provides three separate strips for defining measurement parameters:

- Luminescence
- Luminescence Multicolor
- Luminescence Scan

The availability of the strips depends on the configuration of the instrument connected.

## 9.5.1 Luminescence Strip

The **Luminescence** strip is used to perform luminescence measurements with or without luminescence filters.

### Instrument with Standard Luminescence Module

Figure 30: Luminescence strip for the standard luminescence module

The **Luminescence** strip includes the following elements:

<b>Name</b>	Enter a label name.
<b>Attenuation</b>	Select the attenuation settings for the measurement: <ul style="list-style-type: none"> <li>• <b>None:</b> no attenuation applied</li> <li>• <b>OD1:</b> signal intensity is attenuated by the factor 10</li> <li>• <b>OD2:</b> signal intensity is attenuated by the factor 100</li> <li>• <b>Automatic:</b> attenuation settings are defined and set automatically for each well</li> </ul>
<b>Integration time [ms]</b>	Define the duration time for the signal integration. Enter a value within the valid instrument range.



**NOTE:** Luminescence signals measured with the attenuation filter OD1 and OD2 are automatically corrected by a factor of 10 and 100, respectively.

<b>Settle time [ms]</b>	Define the time delay between plate movement and the start of signal integration. Enter a value within the valid instrument range.
<b>Output</b>	Define the signal readout. Select one of the following options: <ul style="list-style-type: none"> <li>• <b>Counts:</b> the readout is displayed as total counts measured per well</li> <li>• <b>Counts/s:</b> the readout is displayed as counts per second measured per well</li> </ul>
<b>Show advanced settings</b>	Click here to access <b>Settle time</b> and <b>Output</b> settings.

## Instrument with Enhanced Luminescence Module

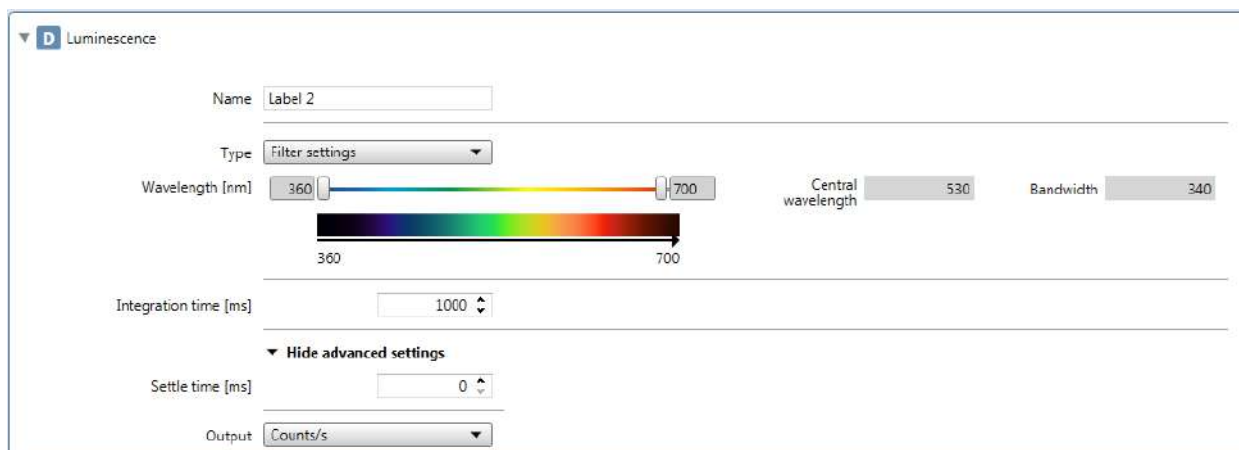

Figure 31: Luminescence strip with interactive graphic for the enhanced luminescence module

The **Luminescence** strip includes the following elements:

<b>Name</b>	Define a label name.
<b>Type</b>	Select the measurement type: <ul style="list-style-type: none"> <li>• <b>Attenuation</b> for measurement signals with no wavelength discrimination</li> <li>• <b>Filter settings</b> for measurement signals with wavelength discrimination</li> </ul>
<b>Attenuation</b>	Define the attenuation settings for the measurement. Select one of following options: <ul style="list-style-type: none"> <li>• <b>None:</b> no attenuation applied</li> <li>• <b>OD1:</b> signal intensity is attenuated by the factor 10</li> <li>• <b>OD2:</b> signal intensity is attenuated by the factor 100</li> <li>• <b>OD3:</b> signal intensity is attenuated by the factor 1000</li> <li>• <b>Automatic:</b> the appropriate attenuation settings are defined and set automatically for each well</li> </ul>



**NOTE:** Luminescence signals measured with the attenuation filters OD1, OD2 and OD3 are automatically corrected by the factor 10, 100, and 1000, respectively.

<b>Filter settings</b>	Define the band pass filter for signal detection. Select the <b>From</b> and <b>To</b> wavelength by moving the respective sliders. Switch to the numeric interface by clicking the List button in the upper right-hand corner of the strip. Select the appropriate wavelength values from the corresponding drop-down lists.
<b>Integration time [ms]</b>	Define the duration time of the signal integration. Enter a value within the valid instrument range.



**NOTE:** When working with band pass filters, the central wavelength with the bandwidth resulting from the corresponding filter settings is automatically displayed.

<b>Settle time [ms]</b>	Define a time delay between a plate movement and the start of signal integration. Enter a value within the valid instrument range.
<b>Output</b>	Define the signal readout. Select one of the following options: <ul style="list-style-type: none"> <li>• <b>Counts:</b> the readout is displayed as total counts measured per well</li> <li>• <b>Counts/s:</b> the readout is displayed as counts per second measured per well</li> </ul>
<b>Show advanced settings</b>	Click here to access the <b>Settle time</b> and <b>Output</b> settings.

## 9.5.2 Multicolor Luminescence Strip

The **Multicolor Luminescence** strip is available only for instruments with the enhanced luminescence module. Select the strip to set-up a user-defined multicolor luminescence measurement or use the strip to select one of the pre-defined settings optimized for common commercial applications.

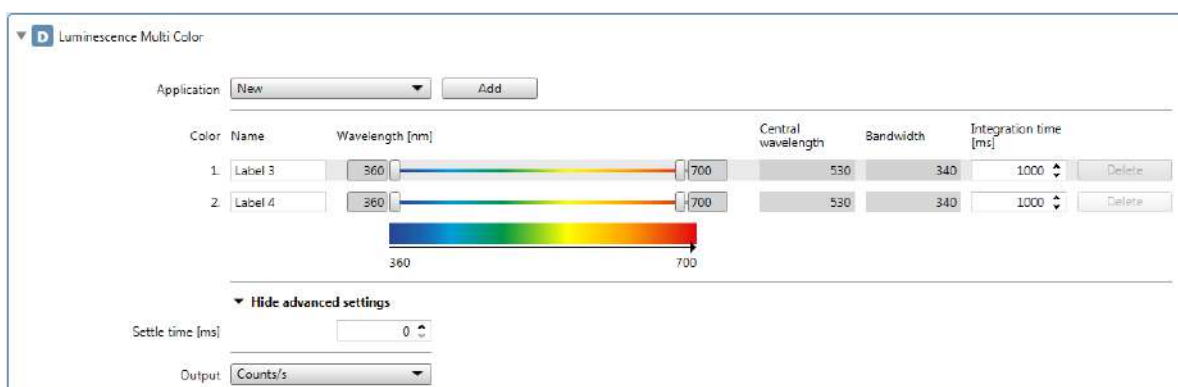

Figure 32: Multicolor Luminescence strip with interactive elements

The **Multicolor Luminescence** strip includes the following elements:

<b>Application</b>	Select <b>New</b> to define a new application. Select the application name (e.g. BRET1, BRET2, BRET3 or Chroma-Glo) to work with the predefined filter settings optimized for each respective application.
<b>Add</b>	Click the <b>Add</b> button to add a label to the list.
<b>Color</b>	Indicates a number of labels to be measured. A minimum of two and a maximum of five can be defined.
<b>Name</b>	Define a name for each label.
<b>Filter settings</b>	Define the band pass filter used for the signal detection of each label: <ul style="list-style-type: none"> <li>• Select the <b>From</b> and <b>To</b> wavelengths by moving the respective sliders</li> <li>• Switch to the numeric interface by clicking the List button in the upper right-hand corner of the strip. Define the <b>From</b> and <b>To</b> wavelengths by selecting the appropriate wavelength values from the corresponding drop-down lists</li> </ul>

<b>Integration time [ms]</b>	Define the duration time of the signal integration for each label. Enter a value within the valid instrument range.
<b>Delete</b>	Click the <b>Delete</b> button to remove a label from the list.



**NOTE:** When working with band pass filters, the central wavelength and bandwidth are automatically displayed according to the corresponding filter settings.

<b>Settle time [ms]</b>	Define a time delay between the plate movement and the start of signal integration. Enter a value within the valid instrument range.
<b>Output</b>	Define the signal readout. Select one of the following options: <ul style="list-style-type: none"> <li>• <b>Counts:</b> the readout is displayed as total counts measured per well</li> <li>• <b>Counts/s:</b> the readout is displayed as counts per second measured per well</li> </ul>
<b>Show advanced settings</b>	Click here to access the <b>Settle time</b> and <b>Output</b> settings.

### 9.5.3 Luminescence Scan Strip

The **Luminescence Scan** strip is available only for instruments with the enhanced luminescence module. Select the strip to perform luminescence scans.

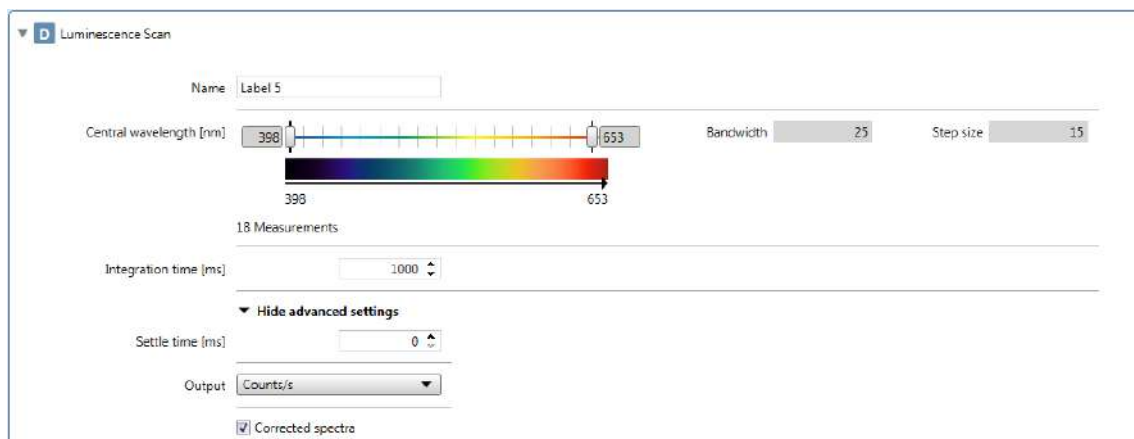

Figure 33: Luminescence Scan strip

The **Luminescence Scan** strip includes the following elements:

<b>Name</b>	Define a label name.
<b>Central wavelength [nm]</b>	<p>Define the central wavelength range to be used for the luminescence scan.</p> <ul style="list-style-type: none"> <li>Select the <b>From</b> and <b>To</b> central wavelengths by moving the respective sliders.</li> <li>Switch to the numeric interface by clicking the List button in the upper right-hand corner of the strip. Select the appropriate wavelength values from the corresponding drop-down lists.</li> </ul>
<b>Integration time [ms]</b>	Define duration time for the signal integration for each label. Enter a value within the valid instrument range.



**NOTE:** The luminescence scan is performed at discrete central wavelengths resulting from the combination of the luminescence filters. The wavelength range is defined by the first and the last central wavelength that also represent the starting and the end point of the scan. All remaining measurement points are automatically derived from the range settings.



**NOTE:** The bandwidth and step size of the luminescence scan measurements are fixed and cannot be changed by user.

<b>Settle time</b>	Define a time delay between plate movement and the start of signal integration. Enter a value within the valid instrument range.
<b>Output</b>	<p>Define the signal readout. Select one of the following options:</p> <ul style="list-style-type: none"> <li><b>Counts:</b> the readout is displayed as total counts measured per well</li> <li><b>Counts/s:</b> the readout is displayed as counts per second measured per well</li> </ul>
<b>Corrected spectra</b>	If selected, the result is a corrected spectrum.
<b>Show advanced setting</b>	Click here to access the <b>Settle time</b> , <b>Output</b> and <b>Corrected spectra</b> settings.

### 9.5.4 Corrected Spectra

The luminescence values are influenced by instrument components as well as by the selected wavelengths and therefore may distort the measured spectra. Calibration data is saved on the instrument and intensity value corrections are performed automatically.

### 9.5.5 Measurement Mode

Luminescence measurements can be defined and performed as:

- Single-label endpoint or kinetic measurements
- Multi-label endpoint or kinetic measurements

All measurements, except luminescence scans, can be carried out plate-wise or well-wise. Luminescence scans can only be performed in a plate-wise manner only.

## 9.6 Optimizing Luminescence Measurements

For optimal performance, it is recommended to use white plates for luminescence measurements.

For enzymatic reactions, care has to be taken to ensure stable environmental conditions for the measurement.



**CAUTION:** Switch on the instrument at least 15 minutes before starting a luminescence measurement to ensure stable conditions for the measurement.

### 9.6.1 Integration Time

At very low light intensity, the measured counts per second are proportional to the light intensity. Increasing the measurement time per well yields more accurate values because of the irregular photon impact (photon statistics). The photonic noise (shot noise) cannot be reduced further by technical means.



**NOTE:** If a luminescence measurement results in an OVER in one or more wells because the measured signal was too high, the luminescence detector may need a certain amount of time to return to the equilibrium baseline count level.

### 9.6.2 Light Attenuation

If the photons entering the photon counting module cannot be distinguished as distinct single exit pulses, results are marked as OVER. The signals can be attenuated by moving neutral density filters into the light path. The OD1 and OD2 neutral density filters, as well as the OD3 option, serve to attenuate high light levels by a factor of 10, 100, and 1000, respectively.

## 9.7 Luminescence Specifications



**NOTE:** All specifications are subject to change without prior notification.

### 9.7.1 General Specifications

Parameters	Standard Luminescence Module	Enhanced Luminescence Module
Wavelength range	370-700 nm	370-700 nm
Wavelength range Luminescence scan	n.a.	390-660 nm
Wavelength discrimination and multicolor luminescence	n.a.	via filter sets
Integration time/well	10 - 60000 ms	10 - 60000 ms
Attenuation	1 OD, 2 OD	1 OD, 2 OD, 3 OD
Dynamic range	$10^7$ - $10^9$	$10^7$ - $10^{10}$

### 9.7.2 Performance Specifications

Glow Luminescence detection limit (Standard and Enhanced Module)		
Plate type/Filling Volume	Parameter	Criteria
96-well plate, white, 200 $\mu$ l	Integration time/well: 1000 ms	ATP: < 50 pM (< 10 fmol/well)
384-well plate, white, 100 $\mu$ l	Integration time/well: 1000 ms	ATP: < 10 pM (< 1 fmol/well)
1536-well plate, white, 10 $\mu$ l	Integration time/well: 1000 ms	ATP: < 1 nM (< 10 fmol/well)

Flash Luminescence detection limit (Standard and Enhanced Module)		
Plate type/Filling Volume	Parameter	Criteria
96-well plate, white, 200 $\mu$ l	Integration time/well: 10000 ms	ATP: < 0.4 pM (< 80 amol/well)
384-well plate, white, 100 $\mu$ l	Integration time/well: 10000 ms	ATP: < 0.8 pM (< 80 amol/well)



## 9.8 Quality Control of the Luminescence Module

### 9.8.1 Periodic Quality Control Tests

Depending on usage and application we recommend a periodic evaluation of the instrument on site at Tecan.

The tests described in the following chapters do not replace a full evaluation by the manufacturer or authorized dealers. But the tests may be performed periodically by the user to check significant aspects of the instrument performance.

The results are strongly influenced by errors in pipetting and the setting of the parameters in the instrument. Therefore please follow the instructions carefully. The user should determine the appropriate intervals for this testing based on how frequently the instrument is operated.



**CAUTION:** Before starting measurements, make sure that the microplate is inserted correctly. The position of well A1 has to be on the upper left side.



**WARNING:** The following instructions explain how to perform the Quality Control to check the specifications of the instrument. If the results of these control tests do not conform to the specifications of the instrument given in this manual, please contact your local service center for further advice.

### 9.8.2 Detection Limit ATP 384-Well Plate

The detection limit is the lowest quantity of a substance that can be distinguished from the blank within a stated confidence limit.

Before pipetting the plate, prepare the instrument for measurement and start the measurement immediately after pipetting.



**CAUTION:** Switch on the instrument at least 15 minutes before starting a luminescence measurement to ensure stable conditions for the measurement.

#### Material:

- ATP Kit SL (BioThema AB, article no. 144-041)
- Greiner 384-well plate, flat bottom, white
- Pipettes + tips

#### Procedure:

Prepare reagents according to the manufacturer's instructions. Adjust ATP Standard to  $10^{-7}$  M.

Pipette 100  $\mu$ l of the Blank into the wells A4 – D10 .

Pipette 20  $\mu$ l of ATP standard  $10^{-7}$  M into the wells A2 – D2, add 80  $\mu$ l of ATP reagent and mix in well **(use fresh tip for each well); ATP reagent must NOT be contaminated with ATP standard!**

### Plate Layout:

	1	2	3	4	5	6	7	8	9	10	11	...	24
A		ATP		B	B	B	B	B	B	B			
B		ATP		B	B	B	B	B	B	B			
C		ATP		B	B	B	B	B	B	B			
D		ATP		B	B	B	B	B	B	B			
E													
...													
P													

ATP: 100µl, 2\*10<sup>-8</sup> M ATP (final concentration in well)  
 B: 100 µl Blank

### Measurement Parameters:

Measurement mode: Luminescence

Integration time: 1000 ms

Plate definition file: GRE384fw

### Evaluation:

Calculate the detection limit (DL) as follows:

$$DL(\text{fmol / well}) = \frac{2 \cdot 10^{-8} * 3 * SD_B}{\text{mean}_{ATP} - \text{mean}_B} * 0.0001 * \frac{1}{1e^{-15}}$$

- 2\*10<sup>-8</sup> Concentration of ATP standard [M]
- SD<sub>B</sub> Standard deviation of Blank (B: A4 – D10)
- mean<sub>ATP</sub> Mean of wells filled with ATP standard
- mean<sub>B</sub> Mean of Blank wells (B: A4 – D10)
- 0.0001 Conversion into mol/well
- 1/1e<sup>-15</sup> Conversion into fmol/well

### 9.8.3 Detection Limit ATP 1536-Well Plate

The detection limit is the lowest quantity of a substance that can be distinguished from the blank within a stated confidence limit.

Before pipetting the plate, prepare the instrument for measurement and start the measurement immediately after pipetting.



**CAUTION:** Switch on the instrument at least 15 minutes before starting a luminescence measurement to ensure stable conditions for the measurement.

### Material:

- ATP Kit SL (BioThema AB, article no. 144-041)
- Greiner 1536-well plate, flat bottom, white
- Pipettes + tips

### Procedure:

Prepare reagents according to the manufacturer's instructions. Adjust ATP Standard to  $10^{-7}$  M.

Pipette 10  $\mu$ l of the Blank into the wells A4 – D10.

Pipette 2  $\mu$ l of ATP standard  $10^{-7}$  M into the wells A2 – D2, add 8  $\mu$ l of ATP reagent and mix in well (use fresh tip for each well); ATP reagent must NOT be contaminated with ATP standard!

### Plate Layout:

	1	2	3	4	5	6	7	8	9	10	11	...	24
A		ATP		B	B	B	B	B	B	B			
B		ATP		B	B	B	B	B	B	B			
C		ATP		B	B	B	B	B	B	B			
D		ATP		B	B	B	B	B	B	B			
E													
...													
P													

ATP: 10  $\mu$ l,  $2 \cdot 10^{-8}$  M ATP (final concentration in well)

B: 10  $\mu$ l Blank

### Measurement Parameters:

Measurement mode: Luminescence

Integration time: 1000 ms

Plate definition file: GRE1536fw

### Evaluation:

Calculate the detection limit (DL) as follows:

$$DL(\text{fmol/well}) = \frac{2 \cdot 10^{-8} * 3 * SD_B}{\text{mean}_{ATP} - \text{mean}_B} * 0.00001 * \frac{1}{1e^{-15}}$$

$2 \cdot 10^{-8}$  Concentration of ATP standard [M]

$SD_B$  Standard deviation of Blank (B: A4 – D10)

$\text{mean}_{ATP}$  Mean of wells filled with ATP standard

$\text{mean}_B$  Mean of Blank wells (B: A4 – D10)

0.0001 Conversion into mol/well

$1/1e^{-15}$  Conversion into fmol/well



# 10 Alpha Technology

## 10.1 Basic Principles

Amplified Luminescent Proximity Homogeneous Assays (AlphaScreen and AlphaLISA) are bead-based nonradioactive, homogeneous and sensitive assays perfectly suited for the study of biochemical interactions. The interaction between an acceptor and donor bead leads to the light output: Upon illumination with a high-energy light source, the photosensitive molecules contained in the donor beads produce high level of oxyradicals. These oxyradicals travel to the acceptor beads and trigger a cascade of reactions that ultimately lead to the generation of a strong chemiluminescent signal.

By using multiple acceptor beads which emit at different wavelengths, multiple analytes can be detected in one well (AlphaPlex™).

## 10.2 Alpha Module

The Alpha module is used for detection of assays based on the Alpha technology (AlphaScreen®, AlphaLISA® and AlphaPlex™). The Alpha module consists mainly of luminescence enhanced and laser module coupled with a contactless IR temperature sensor.

### 10.2.1 Filter

Predefined filters for Alpha based applications are available. Each band pass filter is generated by combination of a long pass and short pass filter built into the filter wheels of the luminescence enhanced module (refer to 9.4.1 Luminescence Filters). The following table shows the wavelength characteristic of the predefined band pass filter:

Alpha Technology	Filter Choice	Central Wavelength/ Bandwidth
AlphaScreen	Long pass filter: 520 nm, Short pass filter: 620 nm	570 nm/100 nm
AlphaLISA	Long pass filter: 610 nm, Short pass filter: 635 nm	622.5 nm/25 nm
AlphaPlex	Long pass filter: 610 nm, Short pass filter: 635 nm Long pass filter: 535 nm, Short pass filter: 560 nm	622.5 nm/25 nm 547.5 nm/25 nm

### 10.2.2 Optics

As excitation light source for Alpha based assays a high-power laser [1] is used. The luminescence fiber [2] guides the light from the sample to the detector passing the filter wheels [4]. Long and short pass filters are installed on the filter wheels. Appropriate filter combinations result in dedicated band pass filters. The aperture wheel [3] adapts the light beam diameter to the used well size.

The Alpha module can be used with all microplate formats supported by the instrument.

Low light levels benefit of the single photon counting detector [5].

The Alpha module is combined with an IR-temperature sensor [6] to compensate for temperature-caused signal differences in every microplate well.

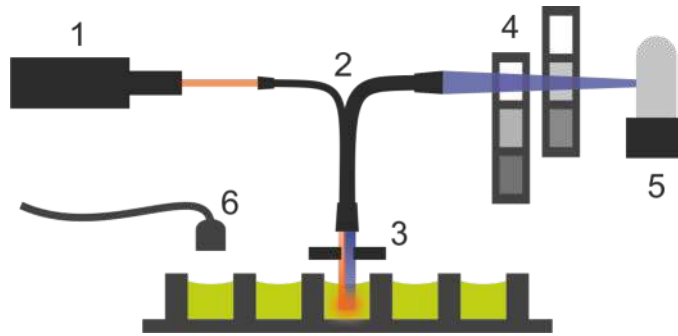

Figure 34: Optical system in Alpha module: [1] laser module; [2] luminescence fiber; [3] aperture wheel; [4] filter wheels; [5] detection unit; [6] IR-temperature sensor

### 10.2.3 Laser

The laser module uses a high power laser (680 nm/750 mW) as the excitation light source. A SPARK 10M instrument equipped with an Alpha module is a LASER CLASS 1 product. The instrument complies with FDA radiation performance standards, 21 CFR 1040.10, except for deviations pursuant to Laser Notice No. 50, dated June 24, 2007.

The following labels are attached to the rear of the instrument:



Complies with 21 CFR 1040.10  
except for deviations pursuant to  
Laser Notice No. 50,  
dated June 24, 2007



**WARNING:** Laser radiation Class IV inside the instrument - Keep the instrument lid closed during measurement.

### 10.2.4 Detection



**CAUTION:** Switch on the instrument at least 15 minutes before starting a measurement to ensure stable conditions for the measurement.

The luminescence and Alpha module detection system utilizes the single photon counting measurement technique. This is based on a dedicated luminescence detector with appropriate measurement circuitry. This technique is very robust against noise, and is, therefore, the preferred method for performing measurements at very low light levels.



**CAUTION:** Use white or light grey plates for Alpha Technology based measurements. Never use black plates and don't measure empty wells to avoid damages caused by laser radiation.

## 10.2.5 Temperature Correction

To compensate for the temperature sensitive nature of Alpha based assays, the Alpha module offers a temperature correction system.

A contactless temperature sensor measures the temperature inside each well and the measured count rates are automatically normalized to a temperature of 22.5°C. Temperature and signal detection is performed in parallel. Due to the position of the temperature sensor the reading direction is from right to left (A12 to A1, B12 to B1 in case of a 96-well plate) if using the temperature correction function.



**NOTE:** To ensure the best performance for Alpha Technology based assays, the Spark should be operated in a temperature-regulated environment ( $\pm 1$  °C in the range of 20–25 °C).

## 10.3 Defining Alpha Measurements

The DragonFly software provides a strip for measuring:

- AlphaScreen
- AlphaLISA
- AlphaPlex
- User-defined Measurements

### 10.3.1 Alpha Technology

The **Alpha Technology** strip is available only for instruments with the Alpha module that includes luminescence enhanced and laser module. Select the strip to detect the readout coming from Alpha Technology based assays.

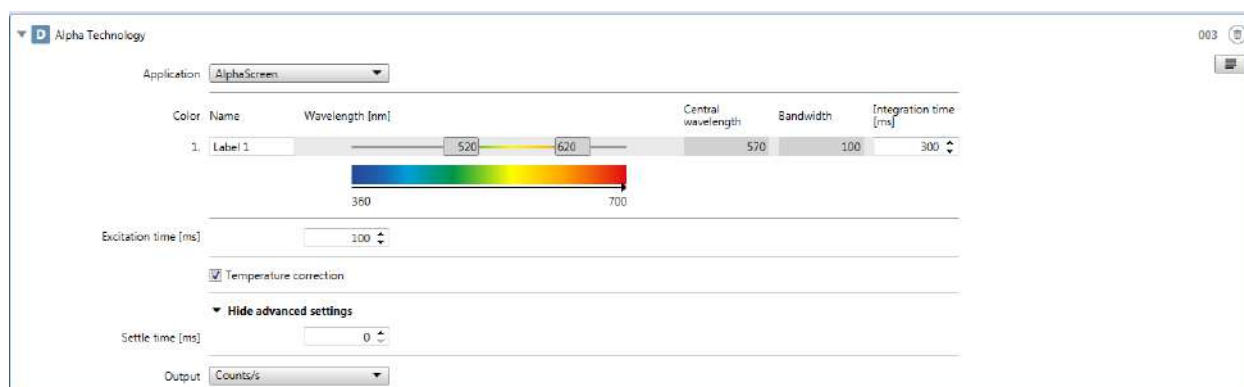

Figure 35: Alpha Technology strip

The **Alpha Technology** strip includes the following definitions:

<b>Application</b>	Select <b>New</b> to define a new application. Select the application name <b>AlphaScreen</b> , <b>AlphaLISA</b> or <b>AlphaPlex</b> to work with the predefined filter settings optimized for each respective application.
<b>Add</b>	Click the Add button to add a label to the list (available for the application <b>New</b> only).
<b>Color</b>	Indicates a number of labels to be measured. A minimum of one and a maximum of two can be defined.
<b>Name</b>	Define a name for each label.
<b>Wavelength [nm]</b>	Define the band pass filter used for the signal detection of each label: <ul style="list-style-type: none"> <li>• Select the <b>From</b> and <b>To</b> wavelengths by moving the respective sliders (Central wavelength and Bandwidth are displayed accordingly)</li> <li>• Switch to the numeric interface by clicking the <b>List</b> button in the upper right-hand corner of the strip. Define the <b>From</b> and <b>To</b> wavelengths by selecting the appropriate wavelength values from the corresponding drop-down lists</li> </ul>
<b>Integration time</b>	Define duration time for the signal integration. Enter a value within the valid instrument range.
<b>Delete</b>	Click the <b>Delete</b> button to remove a label from the list (available for the application <b>New</b> only).
<b>Excitation time</b>	Define duration time of excitation. Enter a value within the valid instrument range.
<b>Temperature correction</b>	Select the check box to activate the temperature correction function.
<b>Settle time</b>	Define a time delay between a plate movement and the start of signal integration. Enter a value within the valid instrument range.
<b>Output</b>	Define the signal readout. Select one of the following options: <ul style="list-style-type: none"> <li>• <b>Counts:</b> the readout is displayed as total counts measured per well</li> <li>• <b>Counts/s:</b> the readout is displayed as counts per second measured per well</li> </ul>
<b>Show advanced settings</b>	Click here to access the <b>Settle time</b> and <b>Output</b> settings.

### 10.3.2 Measurement Mode

Alpha Technology based measurements can be performed as

- Single-label endpoint measurements
- Multi-label endpoint measurements

All measurements can be carried out plate-wise only.



## 10.4 Optimizing Alpha Technology based Measurements

### 10.4.1 Integration Time

Due to irregular photon statistics during signal integration longer integration times per well result in more accurate values. The photonic noise (shot noise) cannot be reduced technically but optimized in pretest experiments by applying different integration times.



**NOTE:** The relevant signal to (shot) noise ratio can be improved by longer integration times per well resulting in increased measurement times of the whole plate.

### 10.4.2 Excitation Time

The excitation time defines the duration of the sample illumination by the laser. Optimizing the excitation time for Alpha Technology based assays may help to minimize sample bleaching and improve the signal-to-noise ratio.

## 10.5 Alpha Specifications



**NOTE:** All specifications are subject to change without prior notification.

### 10.5.1 General and Performance Specifications

Parameters	Specification
Excitation time/well	10 - 1000 ms
Integration Time/well	10 - 60000 ms
Predefined Filter	AlphaScreen, AlphaLISA, AlphaPlex
Temperature correction	available
Detection Limit 384 low volume (Omnibeads)	< 12.5 ng/ml
Uniformity 384 low volume (Omnibeads)	< 8 CV%

## 10.6 Quality Control

### 10.6.1 Periodic Quality Control Tests

Depending on usage and application we recommend a periodic evaluation of the instrument on Tecan site.

The tests described in the following chapters do not replace a full evaluation by the manufacturer or authorized dealers. But the tests may be performed periodically by the user to check significant aspects of the instrument performance.

The results are strongly influenced by errors in pipetting and the setting of the parameters in the instrument. Therefore please follow the instructions carefully. The user should determine the appropriate intervals for this testing based on how frequently the instrument is operated.

We recommend adapting these tests and the acceptance criteria to the laboratory's primary application. Ideally these tests must be performed with the laboratory's own plates, fluorophore, buffers, volumes and all the appropriate settings (filters, flashes, delays, etc.).



**WARNING:** Before starting measurements, make sure that the microplate position A1 is inserted correctly. The position of well A1 has to be on the upper left side..



**WARNING:** This gives instructions on how to check the specifications of the instrument. If the results of these control tests do not lie within the official specifications of the instrument, please contact your local service center for further advice.

### 10.6.2 Detection Limit AlphaScreen Omnibeads 384-Well Plate

The detection limit is the lowest quantity of a substance that can be distinguished from the blank within a stated confidence limit.

Before pipetting the plate, prepare instrument for measurement and start measurement immediately after pipetting.



**CAUTION:** Switch on the instrument at least 15 minutes before starting a measurement to ensure stable conditions for the measurement.

#### Material:

- AlphaScreen Omnibeads (Perkin Elmer)
- Greiner 384-well plate, flat bottom, white
- Phosphate-buffered saline (PBS)
- Pipettes + tips

### Procedure:

Dilute the Omnibeads stock solution 1:500 in PBS by adding 3 µl of the stock solution (5 mg/ml) to 1497 µl PBS yielding a solution of 10 µg/ml. Prepare 12 further dilutions in 1:2 steps by pipetting 750 µl of the previous dilution step to 750 µl PBS. Use a new tip for each dilution step.

Pipette 100 µl of each dilution into 5 replicate wells of the microplate according to the plate layout. Use 100 µl PBS for the blank wells.



**CAUTION:** Use a fresh tip for each concentration and take care NOT to contaminate the blank with any Omnibeads dilution!

### Plate layout:

	2	3	4	5	6	7	8	9	10	11	12	...	24			
A		10.00 µg/ml														
B		5.00 µg/ml														
C		2.50 µg/ml														
D		1.25 µg/ml														
E		0.62 µg/ml														
F		0.31 µg/ml														
G		0.15 µg/ml														
H		0.08 µg/ml														
I		0.04 µg/ml														
J		0.02 µg/ml														
K		0.01 µg/ml														
L		0.005 µg/ml														
M		0.0025 µg/ml														
N		PBS														
O																
P																

100 µl of each Omnibeads concentration (5 replicate wells each)  
100 µl PBS = Blank

### Measurement Parameters:

- Measurement mode: AlphaScreen
- Excitation time: 100 ms
- Integration time: 300 ms
- Temperature correction: activated
- Plate definition file: GRE384fw

## Evaluation:

Calculate the average and standard deviation for each Omnibeads concentration. Perform a blank reduction by subtracting the average signal of the blank wells from the average signal of each Omnibeads concentration.

Plot the average blank-corrected values against the final Omnibeads concentration in a XY scatter diagram. Add a linear trend line with intercept set to 0 and solve the trend line equation ( $y=kx$ ) using the 3-fold standard deviation of the blank as  $y$ .

$$x = \frac{y}{k}$$

$y = 3 \times$  standard deviation of the blank

Extrapolate the detection limit [ng/ml] by using the 3-fold standard deviation of the blank as  $y$ .

### 10.6.3 Uniformity AlphaScreen Omnibeads 384-Well Plate

The uniformity defines the well-to-well variations when measuring a multi-well plate. The uniformity is calculated as percentage deviation from the mean value.

Before pipetting the plate, prepare instrument for measurement and start measurement immediately after pipetting.



**CAUTION:** Switch on the instrument at least 15 minutes before starting a measurement to ensure stable conditions for the measurement.

## Material:

- AlphaScreen Omnibeads (Perkin Elmer)
- Greiner 384-well plate, flat bottom, white
- Phosphate-buffered saline (PBS)
- Pipettes + tips

## Procedure:

Dilute the Omnibeads stock solution 1:2000 in PBS by adding 3  $\mu$ l of the stock solution (5 mg/ml) to 5997  $\mu$ l PBS yielding a solution of 2.5  $\mu$ g/ml.

Pipette 100  $\mu$ l of the Omnibeads dilution into the wells of the microplate according to the plate layout.

### Plate Layout:

	1	2	3	4	5	6	7	8	9	10	11	12	13	14	15	16	17	18	19	20	21	22	23	24
A	O		O		O		O		O		O		O		O		O		O		O		O	
B																								
C	O		O		O		O		O		O		O		O		O		O		O		O	
D																								
E	O		O		O		O		O		O		O		O		O		O		O		O	
F																								
G	O		O		O		O		O		O		O		O		O		O		O		O	
H																								
I	O		O		O		O		O		O		O		O		O		O		O		O	
J																								
K	O		O		O		O		O		O		O		O		O		O		O		O	
L																								
M	O		O		O		O		O		O		O		O		O		O		O		O	
N																								
O	O		O		O		O		O		O		O		O		O		O		O		O	
P																								

O: 100 µl/well Omnibeads dilution (2.5 µg/ml)

### Measurement Parameters:

- Measurement mode: AlphaScreen
- Excitation time: 100 ms
- Integration time: 300 ms
- Temperature correction: activated
- Plate definition file: GRE384fw

### Evaluation:

Calculate the Uniformity as follows:

$$\text{Uniformity(CV\%)} = \frac{SD_o * 100}{\text{mean}_o}$$

SD<sub>o</sub> Standard deviation of wells filled with 2.5 µg/ml Omnibeads solution

mean<sub>o</sub> Mean of wells filled with 2.5 µg/ml Omnibeads



# 11 Absorbance

## 11.1 Basic Principles

Absorbance assays provide a fast and convenient method for qualitative and quantitative characterization of biological compounds. They are based on measuring the amount of light absorbed by the molecules included in a liquid sample when light passes through the sample. The reduced light intensity due to the light absorption by a compound is proportional to the corresponding concentration of that species (Beer-Lambert law) and can be applied for its quantitative analysis (ELISA, protein, nucleic acid quantitation). On the other hand, color changes due to a biochemical reaction in the sample are used to detect a compound of interest in the solution (e.g. qualitative ELISA).

Absorbance signal is a measure for the attenuation of monochromatic light when transmitted through a sample. Absorbance is defined by Beer-Lambert law as:

$$A = \text{LOG}_{10}(I_0/I_{\text{SAMPLE}})$$

Where  $I_{\text{SAMPLE}}$  is the intensity of the transmitted light,  $I_0$  the initial light intensity not attenuated by the sample.

Furthermore, the absorbance depends on the concentration of absorbing compound (C), its extinction coefficient ( $\epsilon$ ) and the path length (d) which the light passes through:

$$A = \epsilon \cdot c \cdot d$$

The unit is assigned as OD (Optical Density):

1 OD means 10-fold light attenuation, i.e. 10 % transmission

2 OD means 100-fold light attenuation, i.e. 1 % transmission

## 11.2 Absorbance Measurement Techniques

### 11.2.1 Absorbance Scan

Absorbance scans measure the absorbance behavior of compounds under investigation within a selected wavelength range. The absorbance spectrum of a compound is often affected by environmental influences such as pH, temperature or protein folding. Therefore it is an essential detection mode for every research group.

## 11.3 Absorbance Module

Absorbance applications can be performed at any wavelength from 200 to 1000 nm. For absorbance measurements, a fiber bundle guides the light from the monochromator to the absorbance optics, which focuses the light into the wells of a microplate. The transmitted light is detected by a silicon photodiode.

Before the measurement of the microplate is performed, a reference measurement is made with the plate carrier moved away from the light beam.

### 11.3.1 Absorbance Optics

The standard absorbance module consists of the flash lamp, the monochromator, the absorbance fiber, and the photodiode (see picture below).

The light of the Xenon-flash lamp [1] (light source) passes an order sorting filter [2] and is focused onto the entrance slit of a single grating monochromator by a condenser mirror. By moving the optical grating [3] the measurement wavelength is selected and focused onto the exit slit of the monochromator. There the light enters the absorbance fiber [4], which guides the light onto the sample by an elliptical mirror [5]. A part of this light is reflected onto a reference photodiode. Afterwards the light is collected by a lens and focused onto the measurement photodiode [6].

The Absorbance module can be used with all microplate formats supported by the instrument.

At the focal point the spot diameter of the absorbance light beam is about 1 mm.

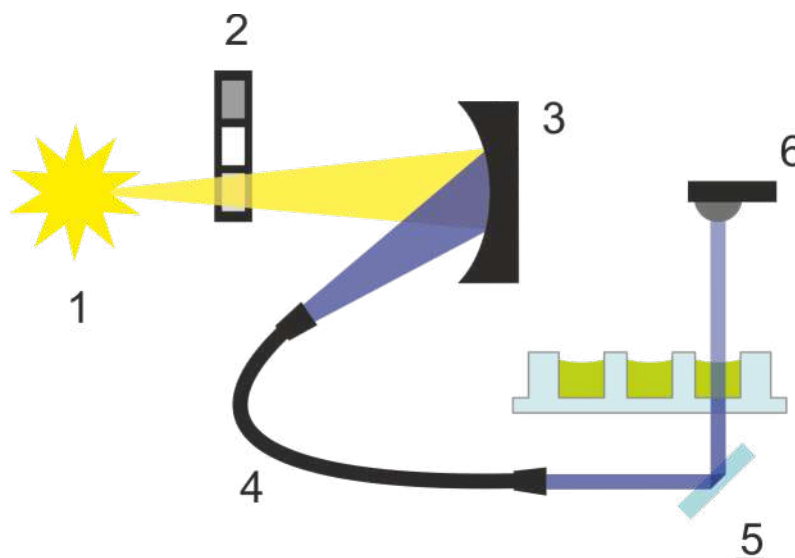

Figure 36: Optical system in absorbance module  
 Xenon-flash lamp [1] (light source), order sorting filter [2],  
 optical grating [3], absorbance fiber [4], elliptical mirror [5],  
 measurement photodiode [6]

#### Detection

A silicon photodiode is used for the measurement of the transmitted light. It is sensitive to a wide range of wavelengths. The photodiode is well suited for the light levels of absorbance measurements below 4 OD.



## 11.4 Cuvette Module

Cuvette based applications can be performed at any wavelength from 200 to 1000 nm. The optical path of the cuvette module is similar to the optical path of the absorbance standard module. A fiber bundle guides the light from the monochromator to the absorbance optics, which focuses the light into the cuvette. The transmitted light is detected by a photodiode.

### 11.4.1 Cuvette Optics

The absorbance cuvette module consists of the flash lamp, the monochromator, the absorbance fiber, and the photodiode (figure).

The light of the Xenon-flash lamp [1] (light source) passes an order sorting filter [2] and is focused onto the entrance slit of a single grating monochromator [3] by a condenser mirror. By moving the optical grating the measurement wavelength is selected and focused onto the exit slit of the monochromator. There the light enters the absorbance fiber [4] which guides the light onto the sample in the cuvette [5]. A part of the light is reflected onto to the reference photodiode. The transmitted light is detected by the measurement photodiode [6]. At the focal point the spot diameter of the absorbance cuvette light beam is about 1 mm.

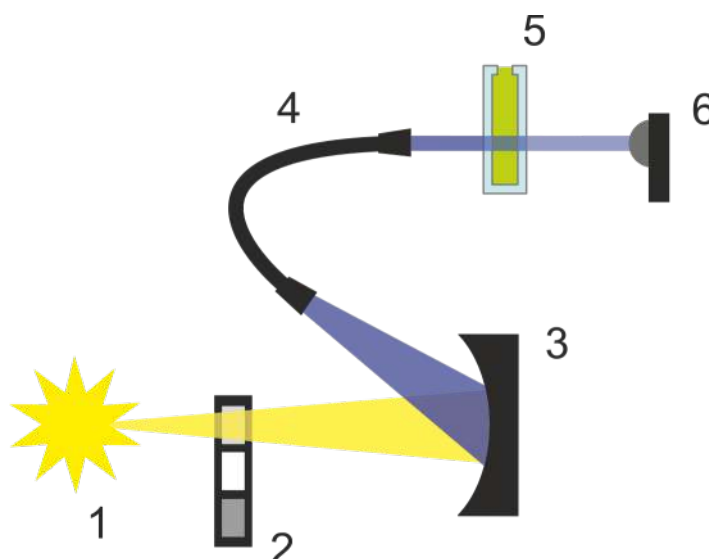

Figure 37: Optical system absorbance cuvette module  
Xenon-flash lamp [1] (light source), order sorting filter [2], optical grating [3], absorbance fiber [4], cuvette [5], measurement photodiode [6]

### Detection

A silicon photodiode is used for the measurement of the transmitted light. It is sensitive to a wide range of wavelengths. The photodiode is well suited for the light levels of absorbance measurements below 4 OD.

## 11.5 Measurement Equipment

### 11.5.1 Microplates

Generally, for absorbance measurements, transparent or UV-transparent microplates are used. For high OD values, black microplates with transparent bottoms are superior. In general, to obtain accurate OD-values measurements above OD3 are not recommended, especially when using 1536-well plates. Dilutions of the measurement samples will result in more accurate data.



**CAUTION:** Use UV compatible microplates for absorbance measurements in UV wavelength range.



**NOTE:** For absorbance measurements of nucleic acids in small volumes (2 µl) use Tecan's NanoQuant Plate. With this device it is possible to measure 16 different samples in one measurement.



**NOTE:** To obtain more accurate measurement data avoid OD-values above 3.

### 11.5.2 Cuvette Adapter

The Tecan cuvette adapter can be used to measure four cuvettes in one measurement. For suitable cuvette dimensions, please refer to the table below. When using the cuvette adapter, the cuvette has to be inserted horizontally and closed tightly to avoid any liquid leakage. Additionally, the cuvette has to be filled with the maximum filling volume to prevent the formation of air bubbles at the measurement window.

The cuvette adapter was created to perform measurements with cuvettes that comply with the following dimensions (table):

Dimension	Parameters
Absolute height (including lid)	35 - 55 mm
Foot print (outer dimension)	12.5 x 12.5 mm
Optical path	10 mm

\*If using a cuvette with different optical path measurement results have to be corrected accordingly.



**CAUTION:** When performing measurements with the cuvette adapter, always use the maximum filling volume of the cuvette to prevent the formation of air bubbles at the measurement window. Close the cuvette tightly to avoid any liquid leakage.

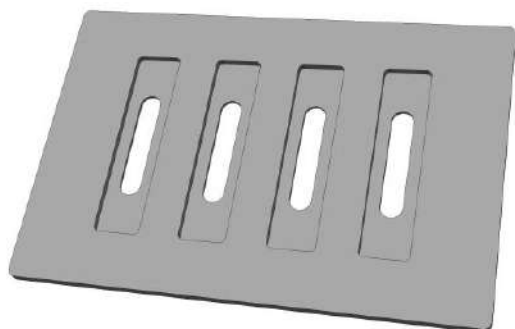

Figure 38: Cuvette adapter



Figure 39: Example of a suitable cuvette type

### 11.5.3 Cuvette Port

Instead of in a microplate, absorbance measurement can be performed in a cuvette that is inserted into the cuvette port of the instrument. The cuvette port was created to perform measurements with cuvettes that comply with the following dimensions (table):

Dimension	Parameter
Absolute height (including lid)	35 - 55 mm
Foot print (outer dimension)	12.5 x 12.5 mm
Optical path	10 mm*
Central height	15 mm
Measurement window	> 2 x 2 mm

\*If using a cuvette with different optical path measurement results have to be corrected accordingly.



**CAUTION:** Always use a valid filling volume. Make sure that the liquid level in the cuvette exceeds 20 mm (height). Too low liquid levels lead to wrong measurement results.



**CAUTION:** The cuvette port cannot be used for cuvette types with a measurement window < 2x2 mm and a center height diverge from 15 mm.



**CAUTION:** The cuvette has to be inserted into the carrier so that the measurement window of the cuvette lines up with the measurement window of the cuvette carrier. For correct insertion please follow the arrow on the cuvette port (see figure below).

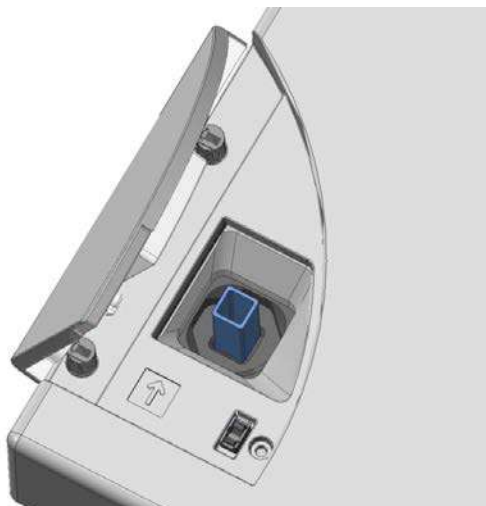

Figure 40: Cuvette Port.

The direction of the arrow on the panel represents the direction of light.



**CAUTION:** Keep the cuvette port closed if it is not in use. Contaminations lead to wrong measurement results.



**CAUTION:** Ensure that the cuvette port is closed properly before starting a cuvette measurement. Open cuvette port lids lead to wrong measurement results.



**CAUTION:** Ensure that the cuvette is inserted properly into the cuvette port before starting a cuvette measurement. Misalignments lead to wrong measurement results.

## 11.6 Defining Absorbance Measurements

The SparkControl software provides two separate strips for measuring:

- Absorbance
- Absorbance Scan

The availability of the strips depends on the configuration of the instrument connected.

### 11.6.1 Absorbance Strip

This strip is used for absorbance measurements.

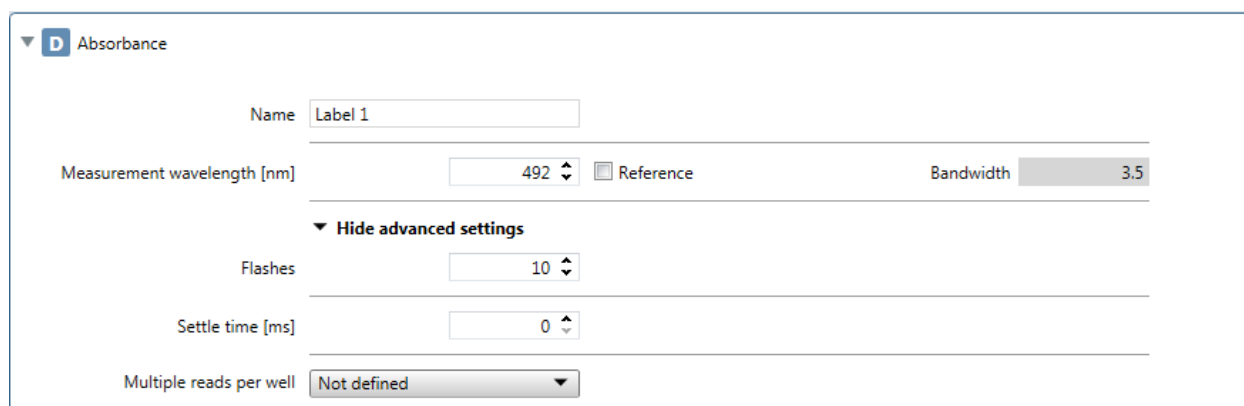

Figure 41: Absorbance strip for absorbance module

The **Absorbance** strip includes the following elements:

<b>Name</b>	Define a label name.
<b>Measurement wavelength [nm]</b>	Enter the measurement wavelength.
<b>Reference</b>	Enter the reference wavelength if required by the application.
<b>Flashes</b>	Enter the number of flashes. For optimal performance, use the default number of flashes.
<b>Settle time</b>	Define a time delay between the plate movement and the start of signal integration. Enter a value within the valid instrument range.
<b>Multiple reads per well</b>	Select <b>User defined</b> in order to define the <b>Type</b> , <b>Size</b> and <b>Border</b> , the multiple reads per well shall be performed with. Use <b>Area Scan</b> to produce a fine granulated picture of the absorbance distribution within a well.
<b>Show advanced settings</b>	Click this expand button to access the following parameters: <b>Flashes</b> , <b>Settle time</b> and <b>Multiple reads per well</b> .

## 11.6.2 Absorbance Scan Strip

This strip is used to perform absorbance scans.

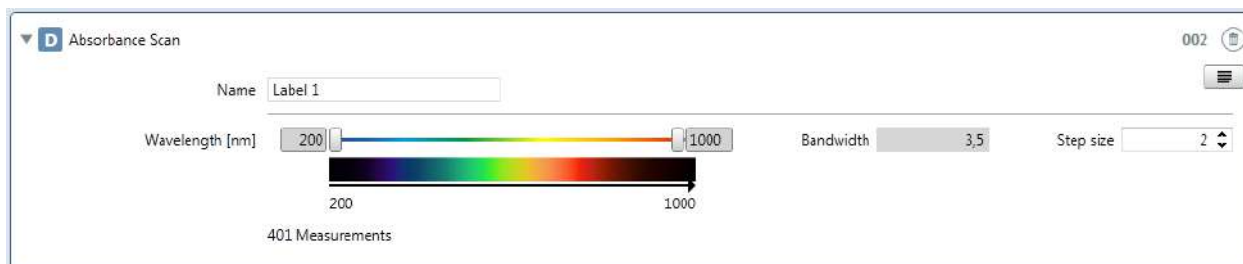

Figure 42: Absorbance scan strip

The **Absorbance Scan** strip includes the following elements:

<b>Name</b>	Define a label name.
<b>Wavelength range</b>	Define the wavelength range to be used for the absorbance scan. Select <b>From</b> and <b>To</b> , i.e. the lower and the upper wavelength limit, respectively. Optionally, use the graphic interface for the wavelength range. Switch to the graphic interface by clicking the 'Graph' button placed top right in the strip. Select the <b>From</b> and <b>To</b> central wavelength by moving the respective slider.
<b>Bandwidth</b>	3.5 nm
<b>Step</b>	Define a step size.



**NOTE:** To achieve maximum speed, absorbance scans are performed with one flash. Up to a step size of 4 nm a proportional increase of speed can be expected. If larger step sizes are defined the increase of measurement speed is no longer proportional to the selected step size.

## 11.7 Absorbance Measurement Modes

Absorbance measurements can be defined and performed as:

- Single-label endpoint or kinetic measurements
- Multi-label endpoint or kinetic measurements

All measurements, except absorbance scans, can be carried out plate-wise or well-wise. Multiple reads per well and absorbance scans can be performed plate-wise only.

### 11.7.1 Optimizing Absorbance Measurements

#### Flash Settings

Measurements with one flash per well are possible for all plate types. However, measurement precision at low light levels depends on the reading time over which the absorbance signal is being collected. By increasing the number of flashes, more accurate results can be achieved.



**NOTE:** Increase the number of flashes per well until the noise of the blank wells does not improve further, or until the measurement time per well becomes unacceptable.

#### Settle Time

Due to the stop and go motion of the plate carrier the liquids meniscus may vibrate during signal integration. Vibrations can cause fluctuations in the measured values, therefore to minimize this effect and to obtain optimal performance, it is recommended to select a settle time between move and flash between 100 and 300 ms.



**NOTE:** To obtain accurate measurement data apply a settle time for plate formats between one- and 96-well.

## 11.8 NanoQuant Application

Tecan provides a ready-to-use NanoQuant app for:

- Quantifying nucleic acids
- Labeling efficiency of nucleic acids

When using the app, the calculations of the nucleic acid and dye contents as well as the purity checks are performed automatically.

For details, see chapter 16 NanoQuant App.

### 11.8.1 NanoQuant Plate

Tecan's NanoQuant Plate is a powerful measurement tool for the quantification of small volumes (2 µl) of nucleic acids in absorbance mode. The NanoQuant plate can also be used for determining the nucleic acid labeling efficiency. In that case, absorbance is measured at 230 nm, 260 nm and 280 nm as well as at the wavelength of the labeled dyes, e.g. 550 and 649 nm for Cy3 and Cy5, respectively.

Special quartz optics ensures outstanding performance and a high rate of reproducibility. It is possible to measure 16 different samples in a single measurement procedure. The NanoQuant Plate is compatible with an eight-channel pipette for quick and easy sample application.



Figure 43: NanoQuant Plate

## 11.9 Absorbance Specifications



**NOTE:** All specifications are subject to change without prior notification.

### 11.9.1 General Specifications

Parameters	Characteristics
Wavelength range	200 - 1000 nm, selectable in 1 nm steps
Wavelength accuracy	≤ 0.8 nm
Wavelength reproducibility	≤ 0.5 nm
Bandwidth fixed wavelength	3.5 nm
Measurement range	0 - 4 OD



### 11.9.2 Performance Specifications in Microplates

Plate Type/Filling Volume	Parameter	Specification	Criteria
96-well plate, transparent, 200 µl	Flashes/well: 25	Accuracy 0–0.8 OD	+/- 0.008 OD
96-well plate, transparent, 200 µl	Flashes/well: 25	Accuracy 0.8–2.5 OD	< +/- 1.0%
96-well plate, transparent, 200 µl	Flashes/well: 25	Accuracy 2.5–3.0 OD	< +/- 1.5%
96-well plate, transparent, 200 µl	Flashes/well: 25	Precision 0–1.2 OD	< +/- 0.006 OD
96-well plate, transparent, 200 µl	Flashes/well: 25	Precision 1.2–3.0 OD	< +/- 0.5%
96-well plate, UV transparent, 200 µl	Flashes/well: 25	Linearity 0–3 OD at 260 nm	R2 > 0.999
96-well plate, transparent, 200 µl	Flashes/well: 25	Uniformity at 1 OD	< 3 %

### 11.9.3 Measurement Times

Parameters	Measurement time
Measurement time 96-well, 1 flash	< 14 seconds
Measurement time 384-well, 1 flash	< 30 seconds
Fast Scan (200-1000 nm, 1 nm steps)	< 5 seconds

Fast reading times are determined by using one flash only, plate-in and plate-out movements are not included in the measurement time.

### 11.9.4 Performance Specifications in Cuvettes (Cuvette port)

Cuvette Type	Parameter	Specification	Criteria
Quartz cuvette, 1 cm light path	Flashes: 25 Wavelength: 260 nm	Detection limit (DNA)	< 0.2 ng/µl dsDNA
Quartz cuvette, 1 cm light path	Flashes: 25 Wavelength: 280 nm	Detection limit (Protein: BSA, IgG, Lysozyme)	< 0.1 mg/ml
Quartz cuvette, 1 cm light path	Flashes: 1	Fast Scan (200-1000 nm, 1 nm steps)	< 5 seconds

## 11.9.5 Specifications for the NanoQuant Plate

### General Specifications for the NanoQuant Plate:

Parameters	Characteristics
Optics	16 quartz lenses (= 16 sample positions)
Quartz lenses	Diameter: 2.2 mm
Optical path	0.5 mm
Sample volume	2 µl

### Performance Specifications for the NanoQuant Plate:

Absorbance	Performance
Detection limit (DNA)	< 2 ng/µl dsDNA
260/280 nm OD ratio accuracy	< 0.07
260/230 nm OD ratio accuracy	< 0.08
Measurement time for DNA quantification (consisting of a full wavelength scan plus fixed wavelength measurements at 230, 260, 280 and 310 nm)	< 8 s / sample
Detection limit (Cy3, Cy5, Alexa Fluor 555, Alexa Fluor 647, Alexa Fluor 660)	0.1 µM
Detection limit (Alexa Fluor 488, Alexa Fluor 546, Alexa Fluor 594)	0.2 µM

## 11.10 Quality Control of the Absorbance Module

### 11.10.1 Periodic Quality Control Tests

Depending on usage and application, we recommend a periodic evaluation of the instrument on Tecan site.

The tests described in the following chapters do not replace a full evaluation by the manufacturer or authorized dealers. But the tests may be performed periodically by the user to check significant aspects of the instrument performance.

The results are strongly influenced by errors in pipetting and the setting of the parameters in the instrument. Therefore, please follow the instructions carefully. The user should determine the appropriate intervals for this testing based on how frequently the instrument is operated.



**CAUTION:** Before starting measurements, make sure that the microplate is inserted correctly. The position of well A1 has to be on the upper left side.



**WARNING:** The following instructions explain how to perform the Quality Control to check the specifications of the instrument. If the results of these control tests do not conform to the specifications of the instrument given in this manual, please contact your local service center for further advice.

## 11.10.2 Uniformity 96-Well Plate

Uniformity is a measure for the well-to-well variations when measuring a multi-well-plate. The uniformity is calculated as percentage deviation from the mean value.

### Material:

- Orange G [60 mg/l] diluted in distilled water (Sigma-Aldrich, O3756)
- Greiner 96-well plate, flat bottom, transparent
- Pipette + tips

### Procedure:

Pipette 200µl of the reagent into the wells of a Greiner 96-well plate (flat bottom, transparent) according to the plate layout.

### Plate Layout:

	1	2	3	4	5	6	7	8	9	10	11	12
A	OG	OG	OG	OG	OG	OG	OG	OG	OG	OG	OG	OG
B												
C	OG	OG	OG	OG	OG	OG	OG	OG	OG	OG	OG	OG
D												
E	OG	OG	OG	OG	OG	OG	OG	OG	OG	OG	OG	OG
F												
G	OG	OG	OG	OG	OG	OG	OG	OG	OG	OG	OG	OG
H												

OG: Orange G [60 mg/l]

### Measurement Parameters:

Measurement mode:	Absorbance
Measurement wavelength:	492 nm
Number of flashes:	25
Settle time	300 ms
Plate definition file:	GRE96ft

### Evaluation:

Calculate the Uniformity (CV %) as follows:

$$\text{Uniformity (CV\%)} = \frac{SD_{OG} * 100}{\text{mean}_{OG}}$$

SD<sub>OG</sub> Standard deviation of wells filled with OG

mean<sub>OG</sub> Mean of wells filled with OG

### 11.10.3 Quality Control of NanoQuant Plate

**Material:**

- Tris-EDTA buffer (BioThema, no. 21-103)
- Tecan NanoQuant Plate
- Pipette + tips

**Procedure:**

Pipette 2  $\mu$ l of the reagent onto all positions of the NanoQuant Plate.

**Measurement Parameters:**

Start the NanoQuant application and perform average blanking procedure over all wells (16 positions).

**Evaluation:**

The test is passed if the average blanking results at OD 260 are in the range of 10 % (CV). If average blanking is out of range, the failed wells are highlighted indicating that these wells are dirty due to lint, fingerprints, etc.

# 12 Fluorescence

## 12.1 General Description

Fluorescence is the emission of light by a molecule when struck by light of a specific wavelength. A single fluorescent molecule can release one fluorescence photon (quantum of light). This is a part of the energy, which has been absorbed by electronic excitation, but could not be released fast enough into thermal energy. Due to this loss of energy by thermal processes, the fluorescence always results at a wavelength higher than the excitation wavelength (Stokes Shift).

The average time it takes between excitation and emission is called the fluorescence lifetime. For many fluorescent molecular species, fluorescence lifetime is on the order of nanoseconds (prompt fluorescence). After excitation, fluorescence emission occurs with a certain probability (quantum yield), which depends on the fluorescent species and its environmental conditions.

## 12.2 Fluorescence Intensity (FI)

In many fluorescence intensity based applications, the intensity of fluorescence emission is measured to determine the abundance of fluorescent labeled compounds. In these assays, all factors having an influence on fluorescence emission need to be controlled experimentally. Temperature, pH-value, dissolved oxygen, type of solvent, etc. may significantly affect the fluorescence quantum yield and therefore the measurement results.

## 12.3 Fluorescence Resonance Energy Transfer (FRET)

The Fluorescence Resonance Energy Transfer is the transfer of excitation energy from a donor molecule to an acceptor molecule without emitting a photon. The acceptor may receive excitation energy from the donor, if both are in close proximity and the emission spectrum of the donor overlaps the excitation spectrum of the acceptor (resonance condition). Therefore, FRET is a process in which the binding events between two fluorescent-labeled compounds can be detected.

## 12.4 Time-Resolved Fluorescence (TRF)

Time-resolved fluorescence applications apply fluorescent acceptors with a long-lived fluorescence signal (e.g. lanthanides like Europium and Terbium). Consequently, the short-lived unspecific background fluorescence signal can be excluded by using a time delay between the excitation and signal integration thus maximizing the signal to background ratio.

## 12.5 Fluorescence Polarization (FP)

Fluorescence polarization measures rotational immobility of a fluorescently labeled compound due to its environment.

Fluorescence polarization is defined by the following equation:

$$P = \frac{(I_{||} - I_{\perp})}{(I_{||} + I_{\perp})}$$

Where  $P$  equals polarization,  $I_{||}$  equals the emission intensity of the polarized light parallel to the plane of excitation and  $I_{\perp}$  equals the emission intensity of the polarized light perpendicular to the plane of excitation.

FP is suitable for binding studies, because tumbling of molecules may be dramatically reduced after binding to a much larger site, resulting in high polarization values.

For a simplified picture of FP, fluorescent molecules may be visualized as antennae, which need suitable orientation to pick up light waves of excitation successfully. Using planar polarized light, only a specifically oriented subset of the randomly oriented molecules is susceptible to excitation.

The FP measurement result will be calculated from two successive fluorescence intensity measurements. They differ in the mutual orientation of polarizing filters, one being inserted into the excitation light path, another in the emission light path.

## 12.6 Fluorescence Intensity Module

The fluorescence module is designed as a Fusion Optics system. The wavelength selection for excitation and emission can be performed by either the monochromator or the filter option. The monochromator and the filter mode are independently combinable for the excitation and the emission and therefore provide a detection system with the maximum flexibility and maximum signal output. Furthermore, the fluorescence signals can be read from top and bottom.

### 12.6.1 How a Monochromator Works

A monochromator is an optical instrument that enables any wavelength to be selected from a defined optical spectrum. Its method of operation can be compared to a tunable optical filter, which allows both the wavelength and bandwidth to be adjusted.

A monochromator consists of an entrance slit, a dispersive element (optical grating) and an exit slit. The dispersive element diffracts the light into the optical spectrum and projects it onto the exit slit.

Rotating the optical grating around its vertical axis moves the spectrum across the exit slit and only a small part of the spectrum (band pass) passes through the exit slit. This means that when the monochromator entrance slit is illuminated with white light, only light with a specific wavelength (monochromatic light) passes through the exit slit. The wavelength of this light is set by the rotation angle of the optical grating. The bandwidth is set by the width of the exit slit. The bandwidth is defined as full width at half maximum intensity (FWHM).

Monochromators block undesired wavelengths, typically amounting to  $10^3$ . This means when the monochromator is set for light with a wavelength of 500 nm and the PMT detects a signal of 10.000 counts, light with different wavelengths creates a signal of only 10 counts. For applications in the fluorescence range, this blocking is often not sufficient because the fluorescence light to be detected is usually much weaker than the excitation light. To achieve a higher level of blocking, two monochromators are connected in series, i.e. the exit slit of the first monochromator acts as the entrance slit of the second monochromator simultaneously. This is known as a double monochromator. In this case, the blocking count reaches a factor of  $10^6$ , a value typically achieved by Interference filters.

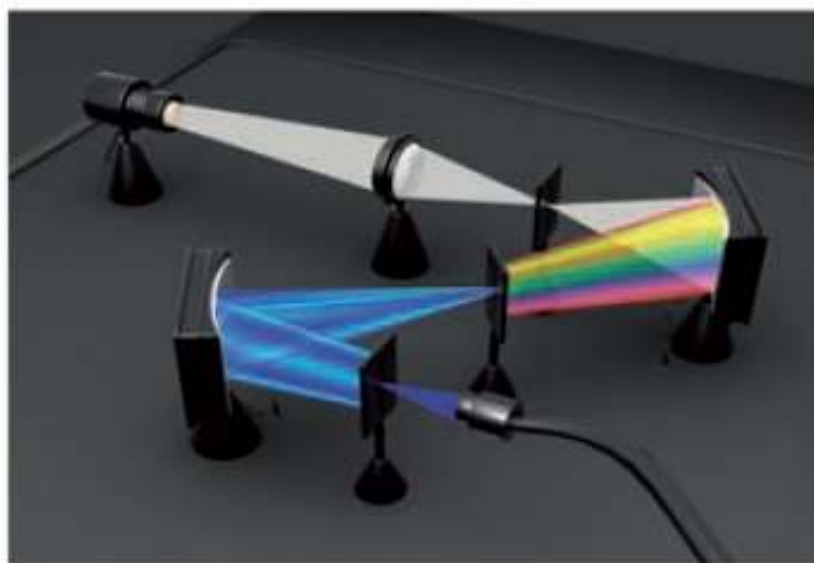

Figure 44: Double monochromator concept

## 12.7 Fluorescence Top Module

### 12.7.1 Fluorescence Top Module Optics

The fluorescence top module consists of a flash lamp as light source, monochromators and/or filters for wavelength selection, a measurement head for top reading, and a photomultiplier tube as detector.

The light source is a Xenon-flash lamp [1]. The measurement head is connected to the excitation and emission modules by fiber bundles. The excitation and the emission lights are guided directly to the fiber by rotating the mirror [2] and the fiber end [3]. The wavelength selection is done either by filters [4] in the measurement head or by double monochromators [5]. The mirror slide [6] in the measurement head can switch between different mirror options. A photomultiplier tube [7] serves as detector.

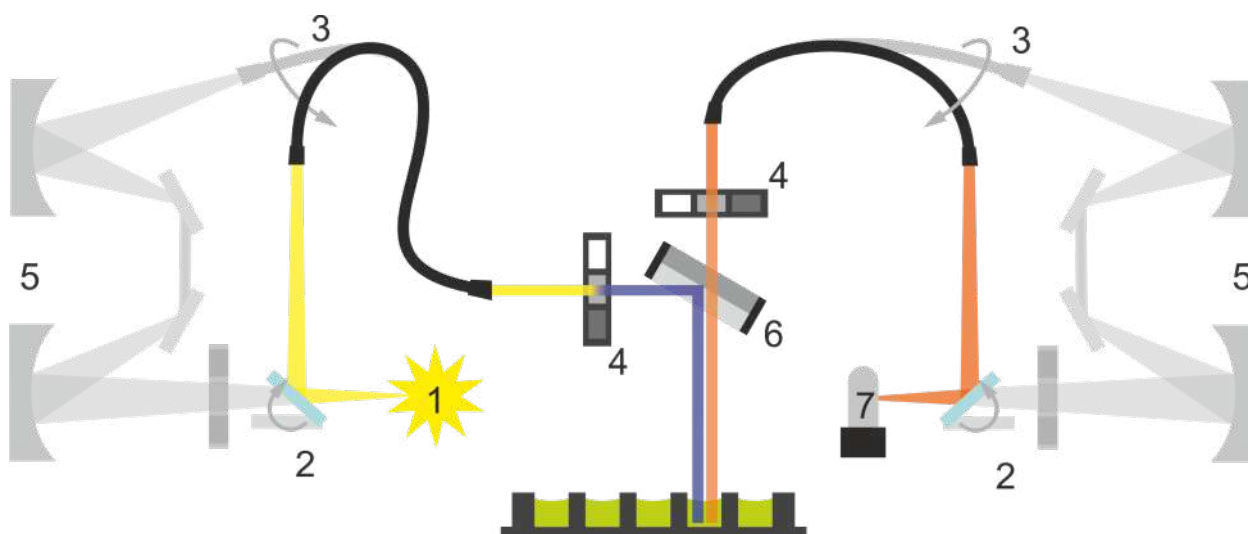

Figure 45: Fluorescence module (Fusion Optics concept) – filter option is highlighted

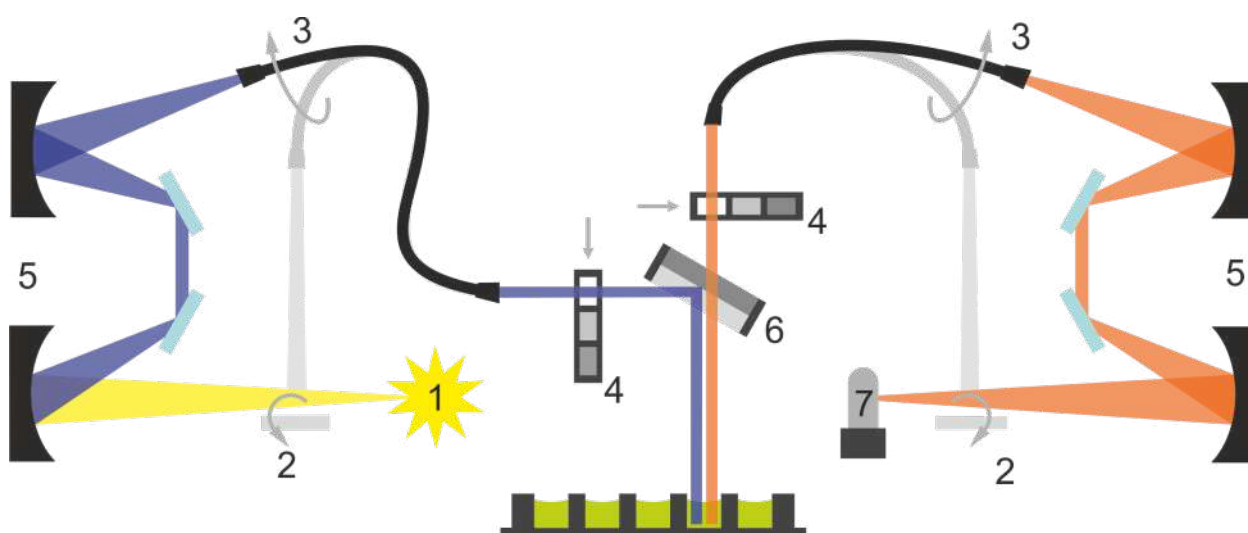

Figure 46: Fluorescence module (Fusion Optics concept) – monochromator option is highlighted



## 12.7.2 Fluorescence Top Module Options

The SPARK 10M can only be equipped with the Fluorescence Standard Module. The SPARK 20M can either be equipped with the Fluorescence Standard Module or the Fluorescence Enhanced Module. In general the Enhanced Module is more sensitive than the Standard Module.

The following table shows the main differences between Fluorescence Standard and Fluorescence Enhanced module:

<b>Description</b>	<b>Standard Module</b>	<b>Enhanced Module</b>
Monochromator bandwidth	Fix: 20 nm	Variable: 5, 7.5, 10, 15, 20, 25, 30, 50 nm
Mirrors	2 mirror positions: 50% mirror, 510 Dichroic	5 mirror positions: 50% mirror, 510 Dichroic, 560 Dichroic, 630 Dichroic, user-definable Dichroic (410 Dichroic or 430 Dichroic)
Flash lamp	5 Watt, 50 Hz	20 Watt, 100 Hz
Plate compatibility	Up to 384-well plates	Up to 1536-well plates

## 12.8 Fluorescence Bottom Module

### 12.8.1 Fluorescence Bottom Module Optics

Based on the fluorescence Fusion Optics system the fluorescence bottom module can be combined with all of its options to select the appropriate wavelengths. The bottom module additionally consists of a fiber bundle, the bottom measurement head, and the bottom cube.

For the description of the Fusion Optics system, refer to 12.6 Fluorescence Intensity Module.

The bottom mirror unit is installed inside the mirror slide [1] and guides the excitation light via bottom fiber [2] to the bottom measurement head [3]. The bottom mirror [4] reflects the light onto the sample. The collected emission light is again guided to the bottom cube by the bottom fiber and focused to the emission fiber [5].

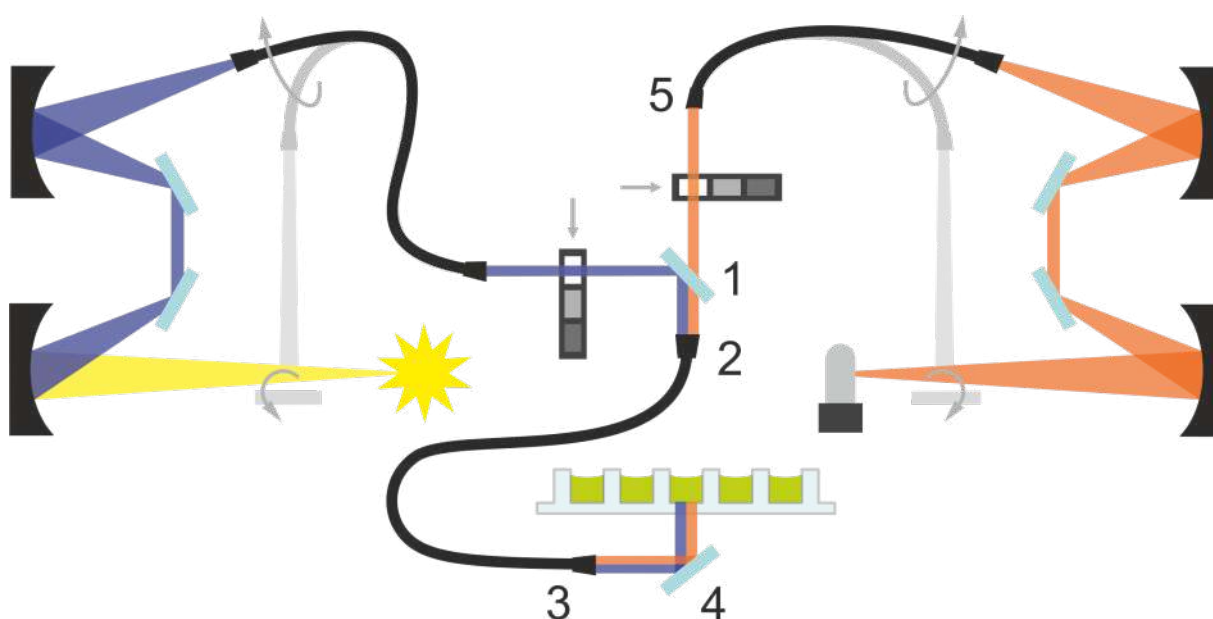

Figure 47: Fluorescence bottom module – monochromator option highlighted

### 12.8.2 Fluorescence Bottom Module Options

The SPARK 10M can only be equipped with the Fluorescence Standard Module. The SPARK 20M can either be equipped with the Fluorescence Standard Module or the Fluorescence Enhanced Module. In general the Enhanced Module is more sensitive than the Standard Module.

The Fluorescence Bottom Standard Module can either be equipped with a VIS- or a UV-VIS fiber. The Fluorescence Bottom Enhanced Module is equipped with a UV-VIS fiber by default.

For further differences between Fluorescence Standard and Fluorescence Enhanced Module, see chapter 12.7 Fluorescence Top Module.

## 12.9 Fluorescence Functions

### 12.9.1 Z-Positioning

The Z-position defines the distance between the measurement head and the surface of the microplate. It can be adjusted by moving the plate transport up and down. As light is reflected onto the sample liquid surface, a Z-adjustment helps to maximize signal to noise ratio.

The Z-position option is available for fluorescence intensity top as well as bottom measurements.

### 12.9.2 Fluorescence Detection

A photo-multiplier tube (PMT) is used for the detection of the low light levels associated with fluorescence. The fluorescence PMT is sensitive up to the near infrared (NIR) while still having low dark current. Electronic circuitry uses analog to digital conversion of PMT input current. The gain is an amplification factor for the PMT. Adjusting the PMT gain enables measurement of a wide range of concentrations in lower or higher concentration domains.

### 12.9.3 Fluorescence Scans

By holding the excitation light at a constant wavelength, the different wavelengths of fluorescent light emitted by a sample are detected via the monochromator. This process defines the recording of an **emission spectrum**. An **excitation spectrum** is the opposite, whereby the emission light is held at a constant wavelength, and the excitation light is scanned through many different wavelengths.

A **3D spectrum** is generated by recording the emission spectra resulting from a range of excitation wavelengths and combining them all together. A three dimensional surface data set is thus obtained: fluorescence emission intensity as a function of excitation and emission wavelengths. A 3D scan over the full wavelength range consists of more than  $4 \times 10^5$  single measurement points.

### 12.9.4 Spectral Intensity Calibration

The fluorescence intensity values are influenced by instrument components as well as by the selected wavelengths and therefore may distort the measured spectra. Calibration data is saved on the instrument and intensity value corrections are performed automatically.

## 12.10 Measurement Equipment

### 12.10.1 Filters

The optical filters (band pass filters) are mounted in the filter slides. The spectral transmission and the bandwidth of the fluorescence filters are optimized for achieving excellent sensitivity.

Contact Tecan for filters other than those supplied on the delivered filter slides.

## 12.10.2 Filter Slides

Two separate filter slides, an excitation and an emission filter slide, enable the user to work with six independent filter pairs for fluorescence measurements. The information about the inserted filters is saved on the microchip integrated into each filter slide.



**CAUTION:** Relating to filter label and orientation there are two types available. It is important that light travels through the filter in the correct direction. Before inserting a new filter carefully consider the filter and the direction of light through the filter slide.

For filters with an arrow on the side, the light must travel in the same direction as the arrow.



For filters without an arrow, the end with the metal lip must face away from the light source:

Filters have two different ends – one has a lip and one doesn't have a lip.

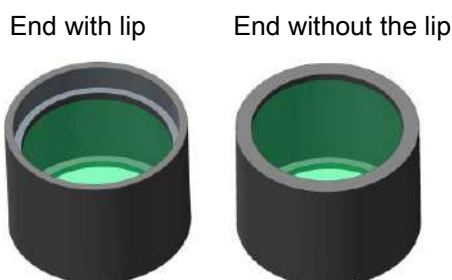

Direction of light through the filter:

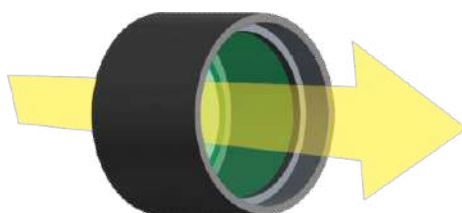

Figure 48: The light travels from the end without the lip towards the end with the lip.

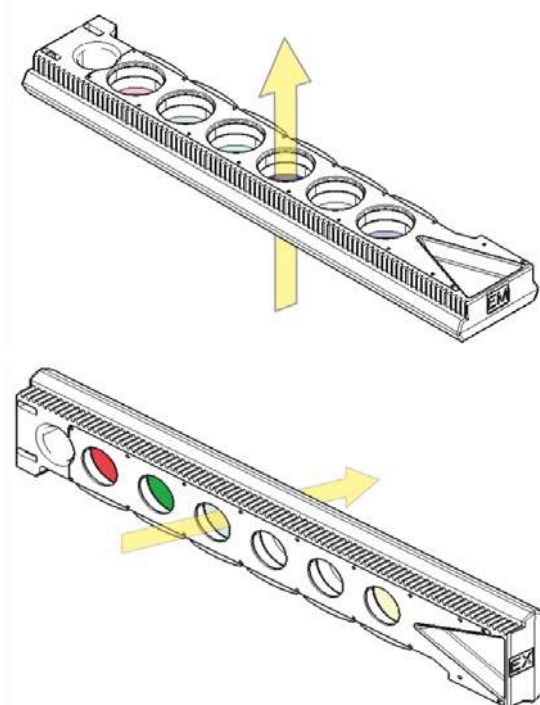

Figure 49: Direction of light through the filter slides

### 12.10.3 Installing and Removing Filters

No special tool is necessary to install or remove the filters of the excitation or emission filter slide.

To install a filter simply push the button next to the appropriate filter slot, insert the filter and release the button to secure the filter in the slot. Check that the filter is positioned firmly on the bottom of the filter slot.



**NOTE:** Make sure that the filters are inserted in the correct direction (see chapter 12.10.2 Filter Slides).



**CAUTION:** The filters are precision optical components, which should be handled by the edges and not scratched or stored face down in a drawer. Once the filters are installed in the slide, they are relatively well protected, but care should be exercised when handling or storing them.

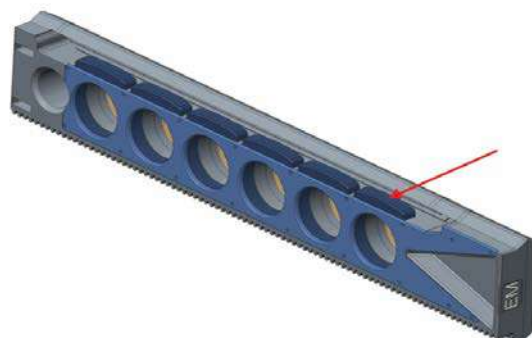

Figure 50: Remove the filter by pushing the button next to the appropriate filter slot (see picture above), turn the filter slide over and the filter will slide out of the slot.

## 12.10.4 Inserting Filter Slides

To insert the filter slides open the door flap manually. For the ease of identification the excitation and emission filter slides are labeled differently. Move the filter slides gently into the respective slots as indicated (chip side first) and push until the drive retract them automatically.



**CAUTION:** Do not push a filter slide further into the instrument when the drive has started to retract it.

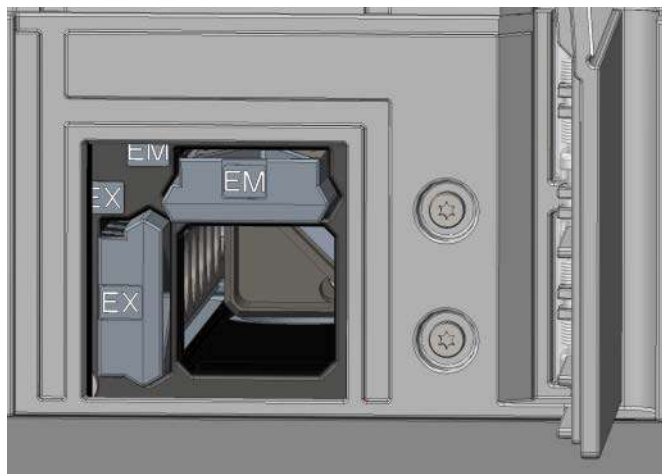

Figure 51: Inserting filter slides

Eject the filter slides via the software or by using the Onboard control button on the front of the instrument (refer to 2.6 Onboard Control Buttons).

## 12.10.5 Defining the Filters



**CAUTION:** Any changes to the filters in the filter slide are to be carried out by trained personnel! The instrument is able to recognize predefined filter slides and you should not attempt to change the filter values.

However, if the filters in the filter slide have been changed or if a new undefined customized filter slide is to be used, the filter slides need to be defined.

A custom filter can be defined via the Filter Definition window in the Dashboard or Method Editor:

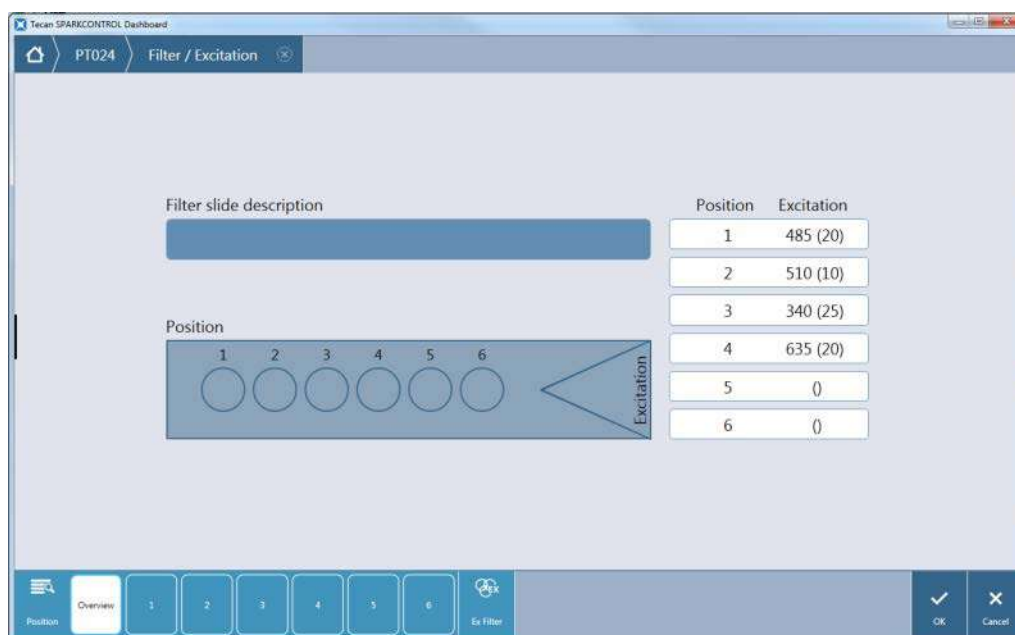

Figure 52: Filter Definition window

**Position/Overview:** The overview provides the user with the current filter slide definition. Optionally, a **Filter slide description** can be entered.



**NOTE:** Alphanumeric Latin characters are allowed as well as defined special characters, including blank, ?, \$, %, ., /.

**Position 1 – 6:** Positions 1 to 6 correspond to the position of a filter on the filter slide. Select the appropriate filter position and enter the **Wavelength** and the **Bandwidth** for each new filter:

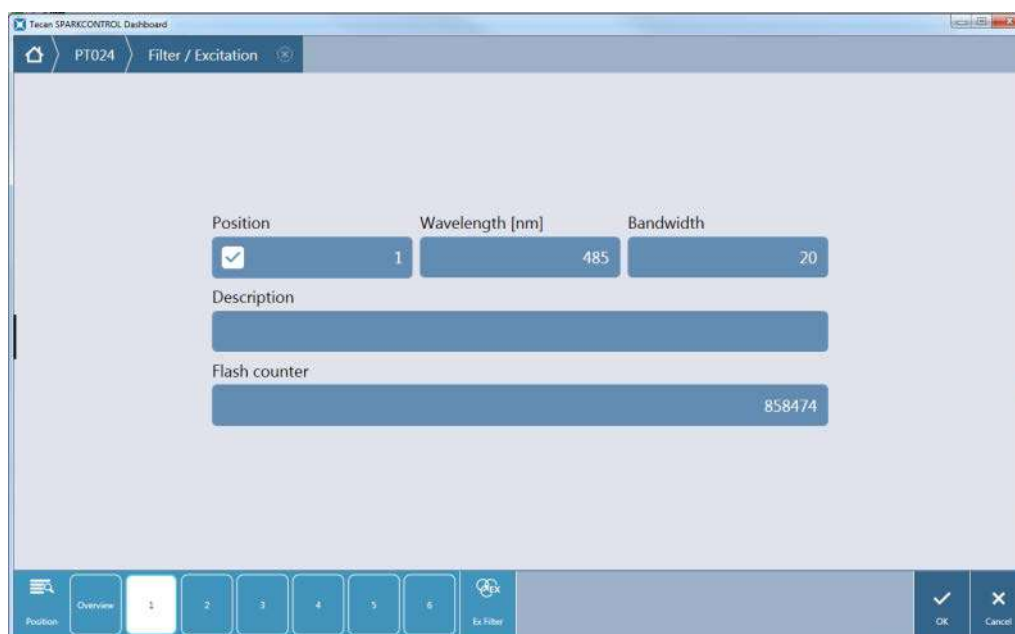

Figure 53: Defining a filter for position 1

Deselect the current **Position** if the selected position is empty, i.e. no filter inserted. Use the **Description** field to add remarks about the filter, e.g. filter name, application, etc.



**NOTE:** Alphanumeric Latin characters are allowed as well as defined special characters, including blank, ?, \$, %, ., /.

**Flash Counter:** The flash counter monitors the number of flashes the filter is exposed to. The number of flashes is saved together with other information about the filter on the microchip. If the filter is replaced this information will be lost.



**CAUTION:** It is recommended to manually document the last flash counter number before replacing a filter. Otherwise this information will be lost.

### 12.10.6 Mirror Slides

Mirrors are used for all Fluorescence Top measurements to reflect the excitation light onto the samples. In case of the Fluorescence Top Standard module the mirror slide is equipped with two different mirror types, in case of the Fluorescence Top Enhanced module five mirror positions are available.

For the performance characteristics of the different mirrors and their availability for the Standard or Enhanced module refer to the following table: The 50 % mirror can be used for all fluorescence measurements independent of the selected wavelength.

Mirror	Reflection (Excitation)	Transmission (Emission)	Availability
50% Mirror	230-900 nm	230-900 nm	FI Top Standard and Enhanced
510 Dichroic (e.g. Fluorescein, HTRF)	320-500 nm	520-780 nm	FI Top Standard and Enhanced
560 Dichroic (e.g. Cy3)	500-550 nm	570-900 nm	FI Top Enhanced
625 Dichroic (e.g. Cy5)	560-625 nm	635-900 nm	FI Top Enhanced
Custom Dichroic	-	-	FI Top Enhanced



**NOTE:** A dichroic mirror needs to match the selected fluorescence excitation and emission wavelength.



## 12.10.7 Installing the Custom Dichroic Mirror

If desired, the mirror slide can be extended with a custom type dichroic mirror. The custom dichroic mirror is delivered separately with the subpackaging and need to be installed and defined before usage.

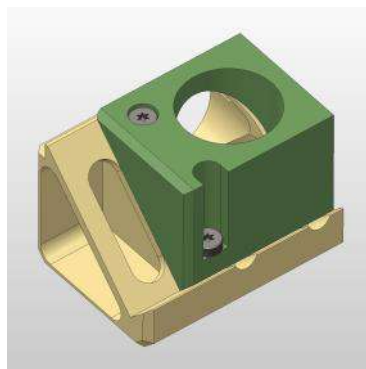

Inclined view

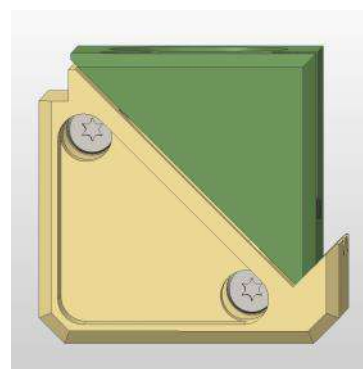

Front view

In order to install the custom dichroic mirror follow these instructions:

1. Open the Mirror Definition window in the Dashboard or Method Editor and select **Mirror Out**. The mirror slide moves to the load position.
2. To install the Custom Dichroic Mirror open the door flap manually. Slide the custom dichroic into the Mirror Carriage as indicated in the figure. Apply and carefully tighten the mounting screws.

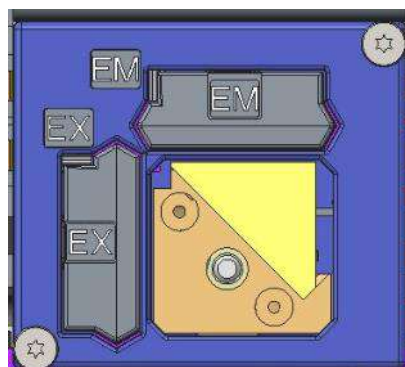

Load position

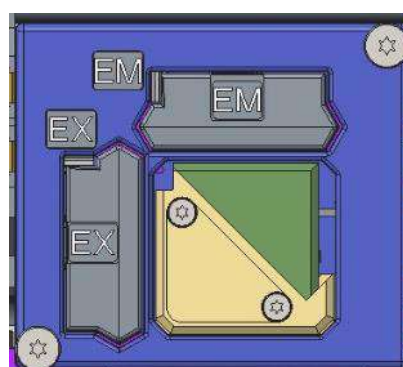

Installed custom dichroic



**CAUTION:** Do not apply too much tork to the mirror slide to avoid damages.

3. Carefully release the door flap and click **Mirror In**. The Mirror Slide moves back into the instrument.
4. The custom dichroic mirror is now ready to be defined (see chapter 12.10.8 Defining the Custom Dichroic Mirror).

## 12.10.8 Defining the Custom Dichroic Mirror



**CAUTION:** If a new undefined dichroic is to be used, it needs to be defined.

A custom dichroic can be defined via the Mirror Definition window in the Dashboard or Method Editor:

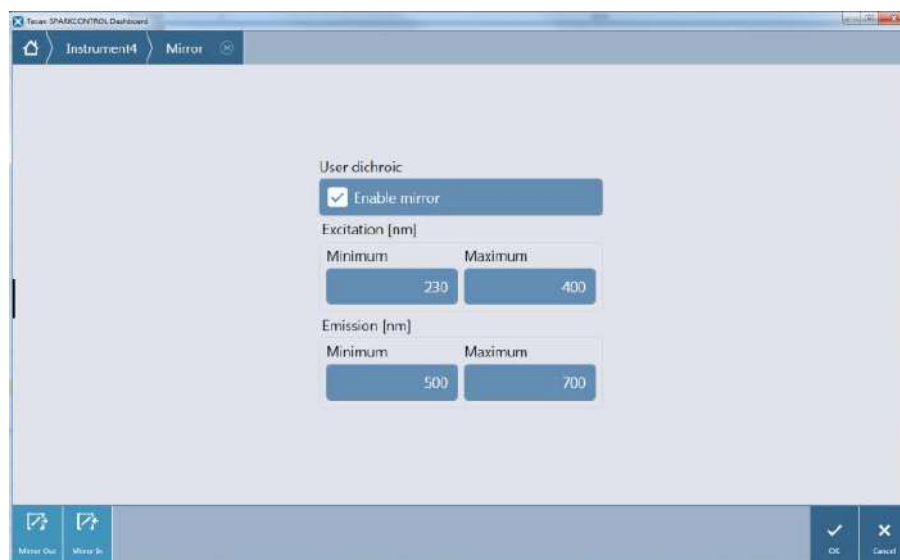

Figure 54: Mirror Definition window

Select **Enable mirror** and define the **Excitation** and the **Emission** range by entering the corresponding **Minimum** and **Maximum** wavelength.

## 12.11 Defining Fluorescence Measurements

The software provides three separate strips for defining measurement parameters:

- Fluorescence Intensity strip
- Time-Resolved Fluorescence Intensity strip
- Fluorescence Intensity Scan strip

The availability of the strips depends on the configuration of the instrument connected.

## 12.11.1 Fluorescence Intensity Strip

This strip is used for fluorescence intensity measurements.

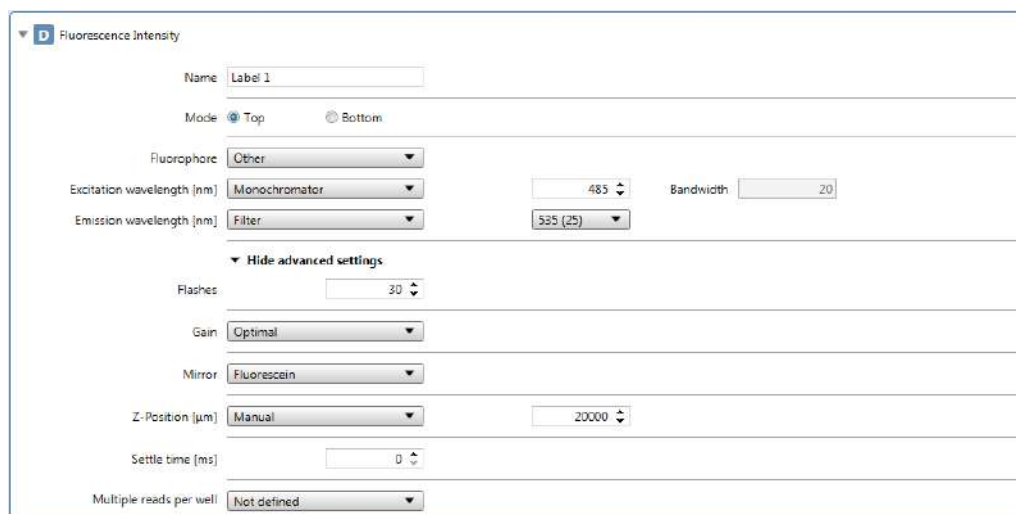
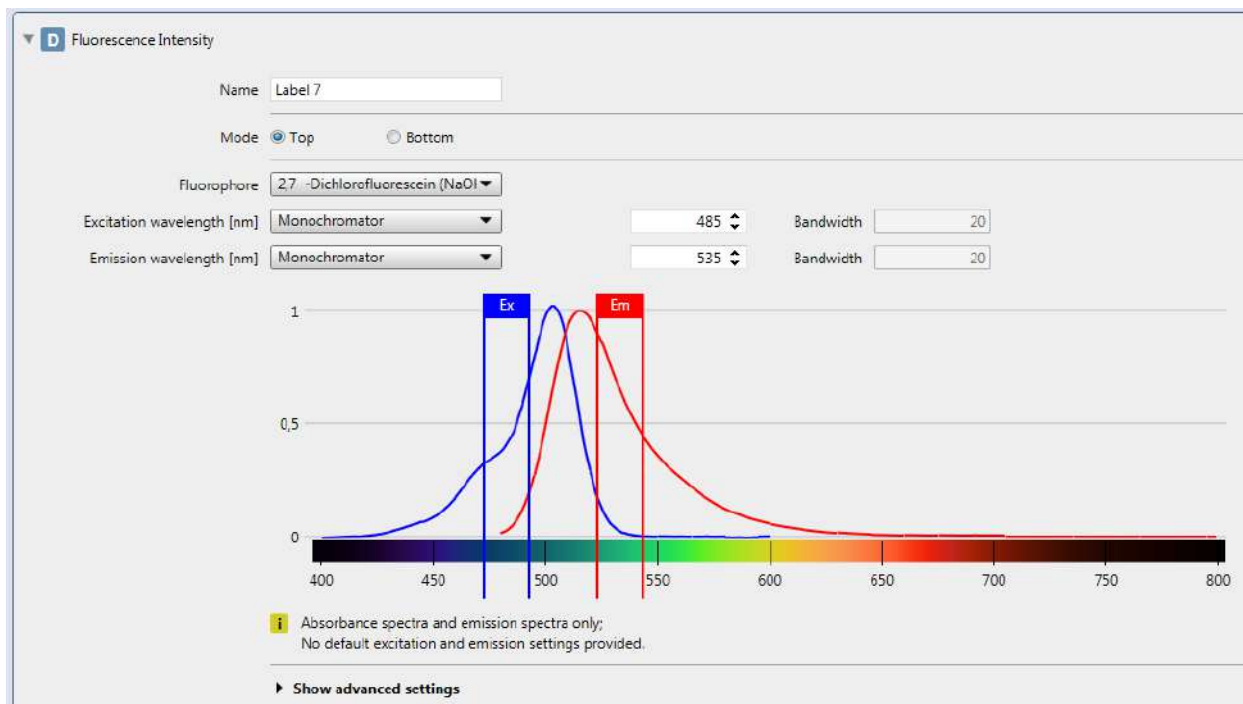

Figure 55: Fluorescence Intensity strip for the fluorescence module

The **Fluorescence Intensity** strip includes the following elements:

<b>Name</b>	Define a label name.
<b>Mode</b>	Select <b>Top</b> for fluorescence intensity top reading and <b>Bottom</b> for fluorescence intensity bottom reading.
<b>Fluorophore</b>	<p>Select a fluorophore and define the excitation and the emission settings by</p> <ul style="list-style-type: none"> <li>Moving the sliders within the graphic display of the corresponding absorption and emission spectra (monochromator systems only) or</li> <li>Selecting/entering the settings manually for the excitation and the emission wavelength (monochromator and filter systems).</li> </ul> <p>Select <b>Other</b> if working with a fluorophore that is not included in the list of fluorophores.</p>



**NOTE:** Tecan provides a list of commercially available fluorophores with their absorption and emission spectra. Fluorophores are not displayed with a recommended wavelength combination for the excitation and emission. The excitation and the emission wavelengths for each respective fluorophore have to be defined by the user.

<b>Excitation wavelength</b>	Define the excitation wavelength. For the Fusion Optics system, select either <b>Monochromator</b> or <b>Filter</b> mode.
<b>Emission wavelength</b>	Define the emission wavelength. For the Fusion Optics system, select either <b>Monochromator</b> or <b>Filter</b> mode.
<b>Bandwidth</b>	For the monochromator, select the bandwidth for excitation and emission if supported by the connected instrument.
<b>Flashes</b>	Enter the number of flashes. For optimal performance use the default number of flashes for each respective instrument.

<b>Gain</b>	<p>Select one of the following modes:</p> <ul style="list-style-type: none"> <li>• <b>Manual gain:</b> define a gain value to be used for the measurement (range: 1-255).</li> <li>• <b>Optimal gain:</b> the optimal gain value is calculated automatically by the instrument according to the highest signal within the selected well range. Optimal gain determination is performed in a pre-measurement. It is recommended to use the optimal gain function for all applications that produce results with unknown RFU values.</li> <li>• <b>Calculated from well:</b> the optimal gain value is calculated for the selected well. The resulting gain value is applied to all other wells within the selected well range.</li> <li>• <b>Extended dynamic range:</b> The optimal gain measurement is done in two consecutive parts, one with a high and one with a low gain. The results of both measurements are automatically correlated and displayed within one single data set. Select this option to optimally adjust the gain settings for very high and very low signals on a microplate within one single measurement.</li> <li>• Use the option <b>% RFU</b> in combination with gain calculation from well (endpoint and kinetic measurements) or optimal gain calculation (kinetic measurements only) to apply only a percentage of the initial gain for the measurement. The percentage may be set individually from 10-100 %, with 100 % as the default value.</li> <li>• <b>Use gain regulation:</b> This option is available for plate-wise kinetic measurements only. By activating this option, fluorescence kinetic measurements with increasing signals are prevented from running into "OVER" once the samples produce RFU values that are too high. Instead the initial gain settings (manual/ optimal/ calculated from well) is automatically reduced in order to permit the measurement of even very high signals. Results obtained with different gain settings are highlighted accordingly. All RFU values with different gain settings are automatically correlated, allowing the evaluation of the entire kinetic data within one and the same graph.</li> </ul>
<b>Mirror</b>	<ul style="list-style-type: none"> <li>• The availability of mirrors depends on the types of (dichroic) mirrors that are installed. Depending on the selected wavelength settings, the appropriate mirror may be set by the instrument (<b>Automatic</b>) or select manually. The selection is possible only for fluorescence intensity top measurement.</li> </ul>
<b>Z-position</b>	<p>Select one of the following options:</p> <ul style="list-style-type: none"> <li>• <b>Manual:</b> define a value that will be used for the measurement</li> <li>• <b>Calculated from well:</b> select a well for the calculation of the Z-position. The optimal Z-position for the selected well is calculated and the corresponding value applied to all other wells within the selected well range.</li> <li>• <b>Same as:</b> Select a label in order to set the Z-position of the current label equal to that of the selected label. This option is available for measurements with more than one fluorescence intensity label.</li> </ul>
<b>Settle time</b>	<p>Define a time delay between a plate movement and the start of signal integration. Enter a value within the valid instrument range.</p>

<p><b>Multiple reads per well</b></p>	<p>Select <b>User defined</b> in order to define the <b>Type</b>, <b>Size</b> and <b>Border</b>, the multiple reads per well shall be performed with.</p> <p>Use <b>Optimal</b> in combination with fluorescence intensity bottom measurement to perform a measurement on multiple, spatially separated spots inside the well.</p> <p>For the instrument with the option Area Scan:</p> <p>Use <b>Area Scan</b> in combination with fluorescence intensity bottom to produce a fine granulated picture of the fluorescence intensity distribution within a well.</p>
<p><b>Show advanced settings</b></p>	<p>Click this expand button to access the following parameters: <b>Flashes</b>, <b>Gain</b>, <b>Z-position</b>, <b>Mirror</b>, <b>Settle time</b> and <b>Multiple reads per well</b>.</p>

### 12.11.2 Time-Resolved Fluorescence Intensity Strip

This strip is used for time resolved fluorescence intensity measurements.

The screenshot shows a configuration window titled 'TR Fluorescence Intensity'. It contains several input fields and dropdown menus:
 

- Name:** A text box containing 'Label 5'.
- Mode:** A dropdown menu set to 'Top'.
- Fluorophore:** A dropdown menu set to 'Other'.
- Excitation wavelength [nm]:** A dropdown menu set to 'Filter' and a numeric input field set to '485 (20)'.
- Emission wavelength [nm]:** A dropdown menu set to 'Filter' and a numeric input field set to '535 (25)'.
- Signal integration [μs]:** Two numeric input fields: 'Lag time' set to '0' and 'Integration time' set to '40'.

 At the bottom of the window is a button labeled 'Show advanced settings' with a right-pointing arrow.

Figure 56: Time-Resolved Fluorescence Intensity strip for fluorescence module

The **Time-Resolved Fluorescence Intensity** strip includes the following elements:

<p><b>Name</b></p>	<p>Define a label name.</p>
<p><b>Mode</b></p>	<p>Select <b>Top</b> for fluorescence intensity top reading and <b>Bottom</b> for fluorescence intensity bottom reading.</p>
<p><b>Fluorophore</b></p>	<p>Select a fluorophore and define the excitation and the emission settings by</p> <ul style="list-style-type: none"> <li>• Moving the sliders available within the graphic display of the corresponding absorption and emission spectra (monochromator systems only) or</li> <li>• Selecting/entering the settings manually using the numeric definition for the excitation and the emission wavelength (monochromator and filter systems).</li> <li>• Select <b>Other</b> if working with a fluorophore that is not included in the list of fluorophores.</li> </ul>



**NOTE:** Tecan provides a list of commercially available fluorophores with their absorption and emission spectra only. Fluorophores are not displayed with a recommended wavelength combination for the excitation and emission. The excitation and the emission wavelengths for each respective fluorophore have to be defined by the user.

<b>Excitation wavelength</b>	Define the excitation wavelength. For the Fusion Optics system, select either <b>Monochromator</b> or <b>Filter</b> mode.
<b>Emission wavelength</b>	Define the emission wavelength. For the Fusion Optics system, select either <b>Monochromator</b> or <b>Filter</b> mode.
<b>Bandwidth</b>	For the monochromator, select the bandwidth for excitation and emission if supported by the connected instrument.
<b>Integration time</b>	Integration time stands for duration of signal recording per well. Select a value within the valid instrument range.
<b>Lag time</b>	Lag time stands for time between flash and the start of signal integration. Select a value within the valid instrument range.



**NOTE:** While lag time is an optional function, the integration time is a mandatory parameter that determines the duration of signal recording. The default values for standard fluorescence intensity measurements are 0  $\mu$ s lag time and 40  $\mu$ s integration time. Time resolved fluorescence measurements typically require a lag time and increased integration time according to the particular application.

<b>Flashes</b>	Enter the number of flashes. For optimal performance use the default number of flashes for each respective instrument.
<b>Gain</b>	Select one of the following modes: <ul style="list-style-type: none"> <li>• <b>Manual gain:</b> define a gain value to be used for the measurement (range: 1-255)</li> <li>• <b>Optimal gain:</b> the optimal gain value is calculated automatically by the instrument according to the highest signal within the selected well range. Optimal gain determination is performed in a pre-measurement. It is recommended to use the optimal gain function for all applications that produce results with unknown RFU values.</li> <li>• <b>Calculated from well:</b> the optimal gain value is calculated for the selected well. The resulting gain value is applied to all other wells within the selected well range.</li> <li>• <b>Extended dynamic range:</b> The optimal gain measurement is done in two consecutive parts, one with a high and one with a low gain. The results of both measurements are automatically correlated and displayed within one single data set. Select this option to optimally adjust the gain settings for very high and very low signals on a microplate within one single measurement.</li> <li>• Use the option <b>% RFU</b> in combination with gain calculation from well (endpoint and kinetic measurements) or optimal gain calculation (kinetic measurements only) to apply only a percentage of the initial gain for the measurement. The percentage may be set individually from 10-100 %, with 100 % as the default value.</li> </ul>

	<ul style="list-style-type: none"> <li>• <b>Use gain regulation:</b> This option is available for plate-wise kinetic measurements only. By activating this option, fluorescence kinetic measurements with increasing signals are prevented from running into “OVER” once the samples produce RFU values that are too high. Instead the initial gain settings (manual/ optimal/ calculated from well) is automatically reduced in order to permit the measurement of even very high signals. Results obtained with different gain settings are highlighted accordingly. All RFU values with different gain settings are automatically correlated, allowing the evaluation of the entire kinetic data within one and the same graph.</li> </ul>
<b>Mirror</b>	The availability of mirrors depends on the types of (dichroic) mirrors that are installed. Depending on the selected wavelength settings, the appropriate mirror may be set by the instrument ( <b>Automatic</b> ) or selected manually. The selection is possible only for fluorescence intensity top measurement.
<b>Z-position</b>	<p>Select one of the following options:</p> <ul style="list-style-type: none"> <li>• <b>Manual:</b> define a value that will be used for the measurement</li> <li>• <b>Calculated from well:</b> select a well for the calculation of the Z-position. The optimal Z-position for the selected well is calculated and the corresponding value applied to all other wells within the selected well range.</li> <li>• <b>Same as:</b> select a label in order to set the Z-position of the current label equal to that of the selected label. This option is available for measurements with more than one fluorescence intensity label.</li> </ul>
<b>Settle time</b>	Define a time delay between a plate movement and the start of signal integration. Enter a value within the valid instrument range.
<b>Multiple reads per well</b>	<p>Select <b>User defined</b> in order to define the <b>Type</b>, <b>Size</b> and <b>Border</b>, the multiple reads per well shall be performed with.</p> <p>Use <b>Optimal</b> in combination with fluorescence intensity bottom measurement to perform a measurement on multiple, spatially separated spots inside the well.</p> <p>For the instrument with the option Area Scan:</p> <p>Use <b>Area Scan</b> in combination with fluorescence intensity bottom to produce a fine granulated picture of the fluorescence intensity distribution within a well.</p>
<b>Show advanced settings</b>	Click this expand button to access the following parameters: <b>Flashes</b> , <b>Gain</b> , <b>Z-position</b> , <b>Mirror</b> , <b>Settle time</b> and <b>Multiple reads per well</b> .



### 12.11.3 Fluorescence Intensity Scan Strip

This strip is used to perform fluorescence intensity scans: excitation, emission and 3D scans.

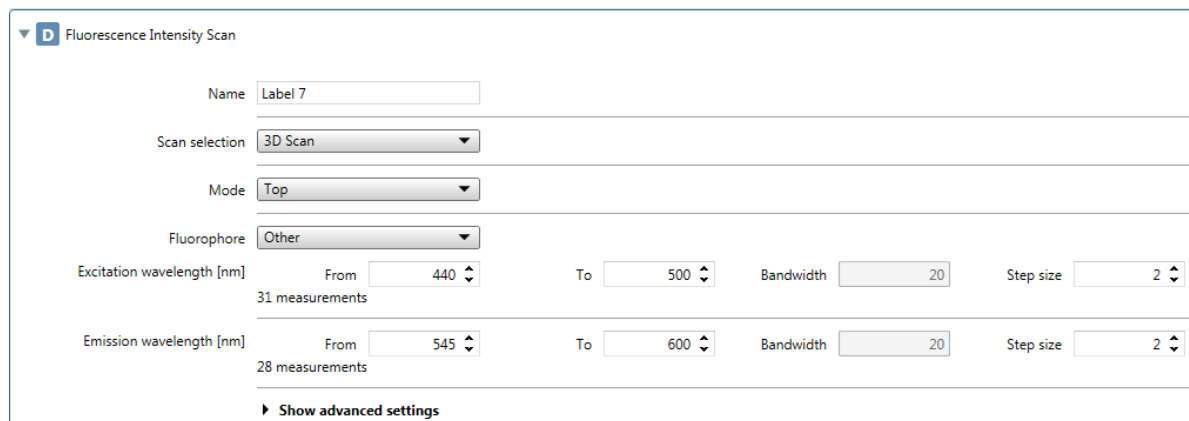

Figure 57: Fluorescence Intensity Scan strip for the fluorescence module

The **Fluorescence Intensity Scan** strip includes the following elements:

<b>Name</b>	Define a label name.
<b>Scan selection</b>	Select <ul style="list-style-type: none"> <li>• <b>Excitation</b> to perform an excitation scan</li> <li>• <b>Emission</b> to perform an emission scan</li> <li>• <b>3D</b> to perform a 3D scan</li> </ul>
<b>Mode</b>	Select <b>Top</b> for fluorescence intensity top reading and <b>Bottom</b> for fluorescence intensity bottom reading.
<b>Excitation wavelength</b>	<b>Excitation scan/3D scan:</b> Define the excitation range by entering From and To values. <b>Emission scan:</b> Define the respective excitation wavelength. For the Fusion Optics system, select either <b>Monochromator</b> or <b>Filter</b> mode.
<b>Emission wavelength</b>	<b>Excitation scan:</b> Define the respective emission wavelength. For the Fusion Optics system, select either <b>Monochromator</b> or <b>Filter</b> mode. <b>Emission scan/3D scan:</b> Define the emission range by entering <b>From</b> and <b>To</b> values.
<b>Bandwidth and Step</b>	For the monochromator, select the bandwidth for excitation and emission if supported by the connected instrument. Define a step size within the valid instrument range to be used for the scan measurement.
<b>Flashes</b>	Enter the number of flashes. For optimal performance use the default number of flashes for each respective instrument.
<b>Gain</b>	<b>Excitation, emission and 3D scan:</b> Define a <b>Manual</b> gain value to be used for the measurement (range: 1-255) <b>3D scan:</b> By selecting <b>Calculated from well</b> the optimal gain value is calculated for the selected well. The resulting gain value is applied to all other wells within the selected well range.

<b>Mirror</b>	The availability of mirrors depends on the types of mirrors that are installed. Depending on the selected wavelength settings, the appropriate mirror may be set by the instrument ( <b>Automatic</b> ) or select manually. The selection is possible only for fluorescence intensity top measurement.
<b>Z-position</b>	Select one of the following options: <b>Manual:</b> define a manual value that will be used for the measurement <b>Calculated from well:</b> select a well for the calculation of the Z-position. The resulting Z-position value is applied to all other wells within the selected well range. <b>Same as:</b> select a label in order to set the Z-position of the current label equal to that of the selected label. This option is available for measurements with more than one fluorescence intensity scan label.
<b>Settle time</b>	Define a time delay between a plate movement and the start of signal integration. Enter a value within the valid instrument range.
<b>Signal integration</b>	<b>Integration time</b> is the duration of signal recording per well. Select a value within the valid instrument range. <b>Lag time</b> is the time between flash and the start of signal integration. Select a value within the valid instrument range.
<b>Show advanced settings</b>	Click this expand button to access the following parameters: <b>Flashes, Gain, Z-position, Mirror, Settle time</b> and <b>Signal integration</b> .

#### 12.11.4 Measurement Mode

Fluorescence measurements can be defined and performed as

- Single-label endpoint or kinetic measurements
- Multi-label endpoint or kinetic measurements

All measurements, except fluorescence scans, can be carried out plate-wise and well-wise. Multiple reads per well as well as fluorescence scan are supported only in the plate-wise manner.

## 12.12 Fluorescence Polarization Module

The fluorescence polarization module is designed as a Fusion Optics system. The wavelength selection for excitation and emission can be performed by either the monochromator or the filter option. The monochromator and the filter mode are independently combinable for the excitation and the emission side and therefore provide a detection system with the maximum flexibility and maximum signal output. The polarization option is available for top measurements only.

The fluorescence polarization Standard Module is available in two versions: a >300 nm or a >390 nm version. The fluorescence polarization Enhanced Module is equipped with the >300 nm version by default.

For further differences between Fluorescence Standard and Fluorescence Enhanced Module see chapter 12.7 Fluorescence Top Module.

### 12.12.1 Fluorescence Polarization Optics

#### Optics

The polarization module consists of a flash lamp as light source, monochromators and/or filters for wavelength selection, a measurement head, and a photomultiplier tube as detector (refer to 12.7.1 Fluorescence Top Module Optics). Polarizers are installed on the measurement head and switched in automatically when performing polarization measurements.

#### Z-Positioning

The Z-position defines the distance between the measurement head and the surface of the microplate. The Z-position can be adjusted by moving the plate transport up and down. As light is reflected onto the sample liquid surface, a Z-adjustment helps to maximize signal to noise ratio.

### 12.12.2 Fluorescence Polarization Detection

Refer to chapter 12.5 Fluorescence Polarization (FP) and 12.9.2 Fluorescence Detection.

#### G-Factor Calculation

The equation for calculation of fluorescence polarization assumes that the sensitivity of the detection system is equivalent for parallel and perpendicular polarized light. This is generally not the case. Therefore the so called G-factor calculation has to be performed. The G-factor compensates for differences in response of the optical components to the parallel and perpendicular polarized light. The G-factor calculation is an important requirement for each fluorescence polarization measurement.

The G-factor is wavelength dependent and requires at least one well containing fluorophore (reference) used in the assay and one well containing the buffer solution without fluorophore (reference blank). Once the G-factor was calculated for a certain fluorophore (assay type) it can be set manually for all further measurements using the same fluorophore. Recalculation of the G-factor has to be performed under following conditions:

- The wavelengths/filters have changed
- New filters are installed on the filter slide
- New assay type with different fluorophore is used



**NOTE:** By using more than one well filled with reference and reference blank, the mean values will be calculated and therefore the G-factor calibration result will be more accurate.



**NOTE:** It is recommended to use a free fluorophore or a fluorophore with a low polarization value for the G-factor calibration.

### 12.12.3 Defining Fluorescence Polarization Measurements

The availability of the Fluorescence Polarization strip depends on the configuration of the instrument connected.

#### Fluorescence Polarization Strip

This strip is used for fluorescence polarization measurements.

Figure 58: Fluorescence Polarization strip

The **Fluorescence Polarization** strip includes the following elements:

Name	Define a label name.
<b>Fluorophore</b>	Select a fluorophore and define the excitation and the emission settings by <ul style="list-style-type: none"> <li>• Moving the sliders available within the graphic display of the corresponding absorption and emission spectra (monochromator systems only) or</li> <li>• Selecting/entering the settings manually using the numeric definition for the excitation and the emission wavelength (monochromator and filter systems).</li> <li>• Select <b>Other</b> if working with a fluorophore that is not included in the list of fluorophores.</li> </ul>



**NOTE:** Tecan provides a list of commercially available fluorophores with their absorption and emission spectra only. Fluorophores are not displayed with a recommended wavelength combination for the excitation and emission. The excitation and the emission wavelengths for each respective fluorophore have to be defined by the user.

<b>Excitation wavelength</b>	Define the excitation wavelength. For the Fusion Optics system, select either <b>Monochromator</b> or <b>Filter</b> mode.
<b>Emission wavelength</b>	Define the emission wavelength. For the Fusion Optics system, select either <b>Monochromator</b> or <b>Filter</b> mode.
<b>Bandwidth</b>	For the monochromator, select the bandwidth for excitation and emission if supported by the connected instrument.
<b>G-Factor</b>	Select <b>Calibrated</b> for automatic calibration of the G-factor by the instrument. Select a reference identifier and the reference blank identifier used for blanking according to the plate layout as defined in the Plate strip. Select <b>Manual</b> , if the measurement is carried out with a G-factor value manually defined by the user or with a calibrated value already available for the selected wavelength combination. If no calibrated G-factor is available, the default value of 1 will be displayed and marked as <b>Uncalibrated G-Factor</b> . Otherwise, a calibrated value will be displayed and marked as <b>Calibrated G-Factor</b> . Both the uncalibrated and the calibrated G-factors can be manually changed by the user. Use the <b>Reset</b> button to recall the original calibrated value.
<b>Blank</b>	Select the blank identifier to be used for blanking according to the plate layout as defined in the <b>Plate</b> strip Select <b>Not defined</b> if the measurement will be performed without blanking.
<b>Flashes</b>	Enter the number of flashes. For optimal performance use the default number of flashes for each respective instrument.
<b>Gain</b>	Select one of the following modes: <ul style="list-style-type: none"> <li>• <b>Manual gain:</b> define a gain value to be used for the measurement (range: 1-255)</li> <li>• <b>Optimal gain:</b> the optimal gain value is calculated automatically by the instrument according to the highest signal within the selected well range. Optimal gain determination is performed in a pre-measurement. It is recommended to use the optimal gain function for all applications that produce results with unknown RFU values.</li> <li>• <b>Calculated from well:</b> the optimal gain value is calculated for the selected well. The resulting gain value is applied to all other wells within the selected well range.</li> <li>• Use the option <b>% RFU</b> in combination with gain calculation from well (endpoint and kinetic measurements) or optimal gain calculation (kinetic measurements only) to apply only a percentage of the initial gain for the measurement. The percentage may be set individually from 10-100 %, with 100 % as the default value.</li> <li>• <b>Use gain regulation:</b> This option is available for plate-wise kinetic measurements only. By activating this option, fluorescence polarization kinetic measurements with increasing signals are prevented from running into “OVER” once the samples produce RFU values that are too high. Instead the initial gain settings (manual/ optimal/ calculated from well) is automatically reduced in order to permit the measurement of even very high signals. Results obtained with different gain settings are highlighted accordingly. All RFU values with different gain settings are automatically correlated, allowing the entire kinetic data to be displayed in one graph.</li> </ul>
<b>Mirror</b>	The availability of mirrors depends on the types of mirrors that are installed. Depending on the selected wavelength settings, the appropriate mirror may be set by the instrument ( <b>Automatic</b> ) or select manually.

<b>Z-position</b>	Select one of the following options: <ul style="list-style-type: none"> <li>• <b>Manual:</b> define a manual value that will be used for the measurement</li> <li>• <b>Calculated from well:</b> select a well for the calculation of the Z-position. The optimal Z-position for the selected well is calculated and the corresponding value applied to all other wells within the selected well range.</li> <li>• <b>Same as:</b> select a fluorescence polarization label in order to set the Z-position of the current label equal to that of the selected label. This option is available for measurements with more than one fluorescence polarization label.</li> </ul>
<b>Settle time</b>	Define a time delay between a plate movement and the start of signal integration. Enter a value within the valid instrument range.
<b>Show advanced settings</b>	Click this expand button to access the following parameters: <b>Flashes</b> , <b>Gain</b> , <b>Z-position</b> , <b>Mirror</b> , and <b>Settle time</b> .

## 12.13 Optimizing Fluorescence and Fluorescence Polarization Measurements

### Gain

The gain defines the amplification factor of the detector when converting light into electrical current.

To provide a proper signal-to-noise ratio and linearity signals must have a suitable input range. Therefore, the gain should be tuned to obtain highest possible signal intensities from the highest concentrated samples allowing to clearly distinguishing lower concentrated samples from the background noise.

To avoid bad performance gain settings below 40 should not be applied.



**NOTE:** If any well of interest is assigned OVER (overflow), you may manually reduce the gain, or select an automatic gain option (optimal gain, gain from well).

### Scan Z-Position

The Z-position can be optimized in the Instrument menu of the Method Editor or via Dashboard. Results of the Z-position scan are shown in a graphical plot.

Select the label(s) for which the Z-position optimization is to be performed. The label selection/number depends on the measurement previously defined in the Method Editor.

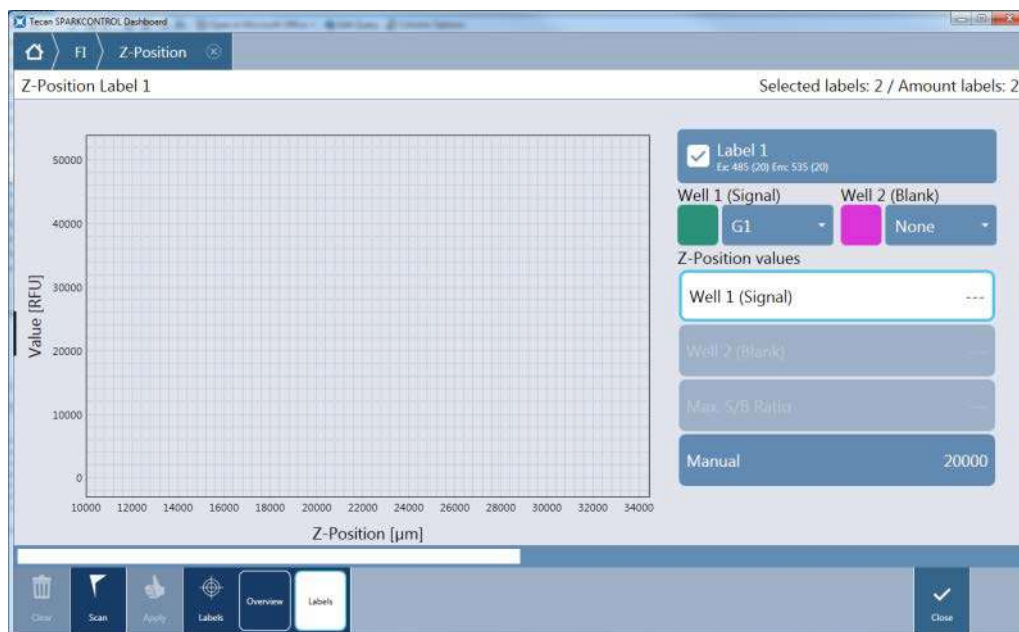

Figure 59: Z-Position window – define parameters

For each selected label, one or two wells of the defined plate range can be used for the Z-position optimization. Select the well(s) and click **Scan** to start the Z-optimization. After the measurement the resulting Z-position curve(s) and the corresponding Z-position value(s) are displayed. Select one of the Z-position values. Upon clicking **Apply**, the selected Z-position will be automatically applied to the method used for the subsequent measurement.

The option **Max. S/B Ratio** is available for fluorescence intensity and fluorescence intensity scan measurements only. It requires the measurement of two wells, one filled with the fluorophore of interest (signal) and one filled with buffer (blank). Both wells are scanned and the resulting signal and blank curves are shown in the graph. The Z-position may now be set to the maximum signal-to-blank (S/B) ratio.

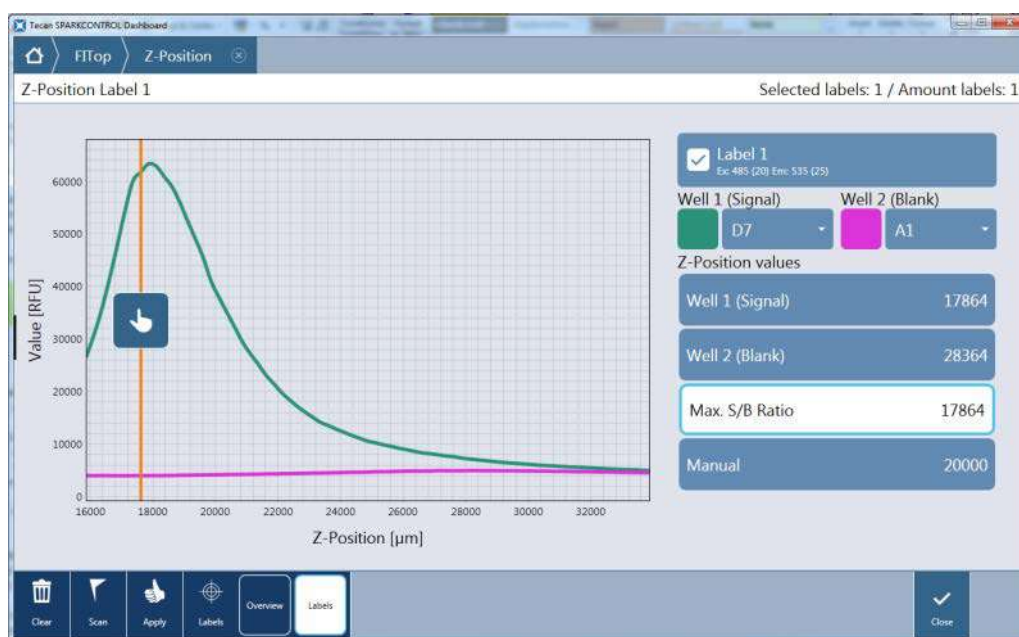

Figure 60: Z-Position window – display of Z-position curves



**NOTE:** When the option **Max. S/B Ratio** is used, the sample well is first measured with optimal gain. The same gain value is applied to the second measurement with the blank well. Therefore, both signal and blank curves are directly comparable.

The Z-position for each selected label can also be selected within the depicted scan curve manually. Move the vertical yellow bar of the graph to the desired Z-position.

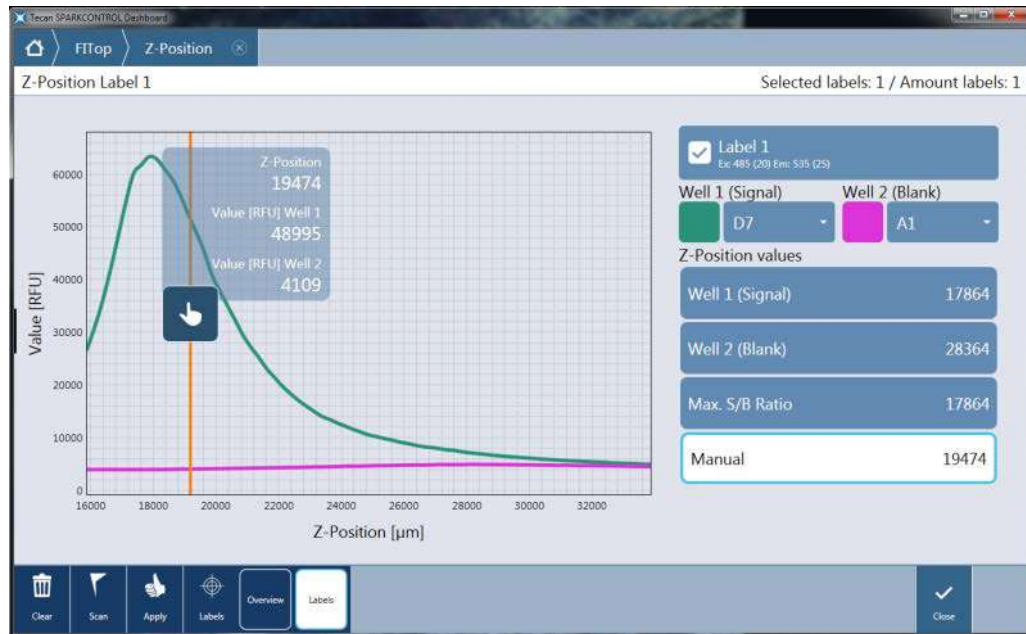

Figure 61: Z-Position window – changing Z-position value manually

## Flash Settings

Measurement with one flash per well is possible for all plate types. Measurement precision at low light levels depends on the total signal integration time. However, increasing the signal integration time will not always result in better signal, as the signal integration might be limited by the length of the fluorescence signal (life time).

Improve the measurement data by increasing the number of flashes instead. The measured intensities of all flashes are averaged resulting in more accurate measurement data.



**NOTE:** Increase the number of flashes per well until noise of blank wells does not improve further, or until the measurement time per well becomes unacceptable.

## Settle Time

Due to the stop and go motion of the plate carrier the dispensed liquids meniscus may vibrate during signal integration. Vibrations can cause fluctuations in the measured values therefore a settle time can be defined to minimize this effect and to optimize performance. The settle times describes the time between move and flash. A settle time between 100 and 300 ms may be applied to fluorescence polarization measurements and fluorescence measurements in plate formats with less than 96 wells to improve data.



## G-Factor

Refer to 12.12.2 Fluorescence Polarization Detection / G-Factor Calculation.

## Multiple Reads per Well

The multiple reads per well option (MRW) is available for fluorescence top and bottom fixed wavelength measurements in order to achieve maximum well illumination. This option is especially applicable for cell based investigations, since the distribution of the cells in the well is often not homogenous.

## 12.14 Fluorescence Specifications



**NOTE:** All specifications are subject to change without prior notification.

### 12.14.1 General Specifications of Fluorescence Intensity (Standard and Enhanced module)

If not otherwise stated the specifications are valid for Standard as well as Enhanced module.

#### Fluorescence Intensity Top:

Parameters	Monochromator	Filter
Wavelength range	Excitation: 230 – 900 nm Emission: 280 – 900 nm selectable in 1 nm steps	Excitation: 230 – 900 nm Emission: 230 – 900 nm
Bandwidth Standard module	20 nm	depends on the filter used
Bandwidth Enhanced module	5, 7.5, 10, 15, 20, 25, 30, 50 nm	depends on the filter used

#### Fluorescence Intensity Bottom (monochromator and filter option):

Parameters	VIS Bottom Fiber	UV-VIS Bottom Fiber
Wavelength range	<b>Monochromator and Filter:</b> 350 – 900 nm, selectable in 1 nm steps (Monochromator only)	<b>Monochromator:</b> Excitation: 230 – 900 nm Emission: 280 – 900 nm, selectable in 1 nm steps <b>Filter:</b> Excitation: 230 – 900 nm Emission: 230 – 900 nm
Bandwidth Standard module - Monochromator	20 nm	
Bandwidth Enhanced module - Monochromator	5, 7.5, 10, 15, 20, 25, 30, 50 nm	
Bandwidth Standard and Enhanced module - Filter	depends on the filter used	

## Gain Options

Gain setting	Values
Manual	1 – 255
Optimal	Automatic
Calculated from well	Automatic
Extended dynamic range	Automatic
Use gain regulation	Automatic

## TRF Parameters

Parameters	Characteristics
Integration time	20 $\mu$ s – 2000 $\mu$ s
Lag time	0 $\mu$ s – 2 ms

## 12.14.2 Performance Specifications of Fluorescence Intensity

### Performance Specifications Fluorescence Intensity Top Standard module

Module	Plate type/Filling Volume	Parameter	Criteria
Monochromator	96-well plate, black, 200 $\mu$ l	Flashes/well: 30	Detection Limit: < 20 pM (1 nM Fluorescein)
Monochromator	384-well plate, black, 100 $\mu$ l	Flashes/well: 30	Detection Limit: < 20 pM (1 nM Fluorescein)
Filter	96-well plate, black, 200 $\mu$ l	Flashes/well: 30	Detection Limit: < 10 pM (1 nM Fluorescein)
Filter	384-well plate, black, 100 $\mu$ l	Flashes/well: 30	Detection Limit: < 10 pM (1 nM Fluorescein)
Monochromator and filter	96-well plate, black, 200 $\mu$ l	Flashes/well: 30	Uniformity: < 3 CV% (25 nM Fluorescein)
Monochromator and filter	384-well plate, black, 100 $\mu$ l	Flashes/well: 30	Uniformity: < 5 CV% (25 nM Fluorescein)

**Performance Specifications Fluorescence Intensity Top Enhanced module**

Module	Plate type/Filling Volume	Parameter	Criteria
Monochromator	384-well plate, black, 100 $\mu$ l	Flashes/well: 30	Detection Limit: < 3 pM (1 nM Fluorescein)
Monochromator	1536-well plate, black, 10 $\mu$ l	Flashes/well: 30	Detection Limit: < 10 pM (1 nM Fluorescein)
Filter	384-well plate, black, 100 $\mu$ l	Flashes/well: 30	Detection Limit: < 2 pM (1 nM Fluorescein)
Filter	1536-well plate, black, 10 $\mu$ l	Flashes/well: 30	Detection Limit: < 7 pM (1 nM Fluorescein)
Monochromator and filter	384-well plate, black, 100 $\mu$ l	Flashes/well: 30	Uniformity: < 3 CV% (25 nM Fluorescein)
Monochromator and filter	1536-well plate, black, 10 $\mu$ l	Flashes/well: 30	Uniformity: < 5 CV% (100 nM Fluorescein)

**Performance Specifications Fluorescence Intensity Bottom Standard module**

Module	Plate type/Filling Volume	Parameter	Criteria
Monochromator	96-well plate, black, transparent bottom, 350 $\mu$ l	Flashes/well: 30	Detection Limit: < 45 pM (1 nM Fluorescein)
Monochromator	384-well plate, black, transparent bottom, 100 $\mu$ l	Flashes/well: 30	Detection Limit: < 45 pM (1 nM Fluorescein)
Filter	96-well plate, black, transparent bottom, 350 $\mu$ l	Flashes/well: 30	Detection Limit: < 35 pM (1 nM Fluorescein)
Filter	384-well plate, black, transparent bottom, 100 $\mu$ l	Flashes/well: 30	Detection Limit: < 35 pM (1 nM Fluorescein)
Monochromator and filter	96-well plate, black, transparent bottom, 200 $\mu$ l	Flashes/well: 30	Uniformity: < 3 CV% (25 nM Fluorescein)
Monochromator and filter	384-well plate, black, transparent bottom, 100 $\mu$ l	Flashes/well: 30	Uniformity: < 5 CV% (25 nM Fluorescein)

**Performance Specifications Fluorescence Intensity Bottom Enhanced module**

Module	Plate type/Filling Volume	Parameter	Criteria
Monochromator	96-well plate, black, transparent bottom, 350 µl	Flashes/well: 30	Detection Limit: < 30 pM (1 nM Fluorescein)
Monochromator	384-well plate, black, transparent bottom, 100 µl	Flashes/well: 30	Detection Limit: < 30 pM (1 nM Fluorescein)
Monochromator	1536-well plate, black, transparent bottom, 10 µl	Flashes/well: 30	Detection Limit: < 40 pM (1 nM Fluorescein)
Filter	96-well plate, black, transparent bottom, 350 µl	Flashes/well: 30	Detection Limit: < 15 pM (1 nM Fluorescein)
Filter	384-well plate, black, transparent bottom, 100 µl	Flashes/well: 30	Detection Limit: < 17 pM (1 nM Fluorescein)
Filter	1536-well plate, black, transparent bottom, 10 µl	Flashes/well: 30	Detection Limit: < 40 pM (1 nM Fluorescein)
Monochromator and filter	384-well plate, black, transparent bottom, 100 µl	Flashes/well: 30	Uniformity: < 3 CV% (25 nM Fluorescein)
Monochromator and filter	1536-well plate, black, transparent bottom, 10 µl	Flashes/well: 30	Uniformity: < 5 CV% (100 nM Fluorescein)

**Performance Specifications Time Resolved Fluorescence (TRF) Standard module**

Module	Plate type/Filling Volume	Parameter	Criteria
Monochromator	96-well plate, white, 200 µl	Flashes/well: 30	Detection Limit: < 5 pM (1 nM Europium)
Monochromator	384-well plate, white, 100 µl	Flashes/well: 30	Detection Limit: < 5 pM (1 nM Europium)
Filter	96-well plate, white, 200 µl	Flashes/well: 30	Detection Limit: < 150 fM (1 nM Europium)
Filter	384-well plate, white, 100 µl	Flashes/well: 30	Detection Limit: < 150 fM (1 nM Europium)

**Performance Specifications Time Resolved Fluorescence (TRF) Enhanced module**

Module	Plate type/Filling Volume	Parameter	Criteria
Monochromator	96-well plate, white, 200 µl	Flashes/well: 30	Detection Limit: < 750 fM (1 nM Europium)
Monochromator	384-well plate, white, 100 µl	Flashes/well: 30	Detection Limit: < 750 fM (1 nM Europium)
Monochromator	1536-well plate, white, 10 µl	Flashes/well: 30	Detection Limit: < 900 fM (1 nM Europium)
Filter	96-well plate, white, 200 µl	Flashes/well: 30	Detection Limit: < 75 fM (0.1 nM Europium)
Filter	384-well plate, white, 100 µl	Flashes/well: 30	Detection Limit: < 75 fM (0.1 nM Europium)
Filter	1536-well plate, white, 10 µl	Flashes/well: 30	Detection Limit: < 100 fM (0.1 nM Europium)

### 12.14.3 General Specifications of Fluorescence Polarization (Standard and Enhanced Polarization module)

If not otherwise stated the specifications are valid for Standard as well as Enhanced module.

Parameters	>390 nm Fiber	>300 nm Polarization Fiber
Wavelength range	<b>Monochromator and Filter:</b> 400 – 850 nm, selectable in 1 nm steps (Monochromator only)	<b>Monochromator and Filter:</b> 300 – 850 nm, selectable in 1 nm steps (Monochromator only)
Bandwidth Standard Polarization module - Monochromator	20 nm	
Bandwidth Enhanced Polarization module - Monochromator	5, 7.5, 10, 15, 20, 25, 30, 50 nm	
Bandwidth Standard and Enhanced Polarization module - Filter	depends on the filter used	

### 12.14.4 Performance Specifications of Fluorescence Polarization

#### Performance Specifications Fluorescence Polarization Standard module (>300 nm and >390 nm)

Module	Plate type/Filling Volume	Parameter	Criteria
Filter	96-well plate, black, 200 µl	Flashes/well: 30	Precision: < 5 mP (1 nM Fluorescein)
Filter	384-well plate, black, 100 µl	Flashes/well: 30	Precision: < 5 mP (1 nM Fluorescein)

#### Performance Specifications Fluorescence Polarization Enhanced module (>300 nm and >390 nm)

Module	Plate type/Filling Volume	Parameter	Criteria
Filter	96-well plate, black, 200 µl	Flashes/well: 30	Precision: < 3 mP (1 nM Fluorescein)
Filter	384-well plate, black, 100 µl	Flashes/well: 30	Precision: < 3 mP (1 nM Fluorescein)
Filter	1536-well plate, black, 10 µl	Flashes/well: 30	Precision: < 5 mP (1 nM Fluorescein)

## 12.14.5 Fastest Measurement Time

Fastest measurement times are determined by using one flash only, manual gain, and manual Z-position. Plate-in and plate-out movements are not included in the measurement time.

Standard module		
Measurement Technique	Measurement Time	
Plate type	96-well	384-well
Fluorescence intensity top filter	≤ 13 seconds	≤ 30 seconds
Fluorescence intensity top monochromator	≤ 14 seconds	≤ 32 seconds
Fluorescence intensity bottom monochromator	≤ 21 seconds	≤ 35 seconds

Enhanced module			
Measurement Technique	Measurement Time		
Plate type	96-well	384-well	1536-well
Fluorescence intensity top filter	≤ 13 seconds	≤ 22 seconds	≤ 34 seconds
Fluorescence intensity top monochromator	≤ 14 seconds	≤ 23 seconds	≤ 36 seconds
Fluorescence intensity bottom monochromator	≤ 19 seconds	≤ 24 seconds	≤ 42 seconds

## 12.15 Quality Control of the Fluorescence Module

### 12.15.1 Periodic Quality Control Tests

Depending on usage and application we recommend a periodic evaluation of the instrument on site at Tecan.

The tests described in the following chapters do not replace a full evaluation by the manufacturer or authorized dealers. But the tests may be performed periodically by the user to check significant aspects of the instrument performance.

The results are strongly influenced by errors in pipetting and the setting of the parameters in the instrument. Therefore please follow the instructions carefully. The user should determine the appropriate intervals for this testing based on how frequently the instrument is operated.



**CAUTION:** Before starting measurements, make sure that the microplate is inserted correctly. The position of well A1 has to be on the upper left side.



**WARNING:** The following instructions explain how to perform the Quality Control to check the specifications of the instrument. If the results of these control tests do not conform to the specifications of the instrument given in this manual, please contact your local service center for further advice.

## 12.15.2 Detection Limit Top/Bottom 96-Well Plate

The detection limit is the lowest quantity of a substance that can be distinguished from the blank within a stated confidence limit.

Before pipetting the plate, prepare the instrument for measurement and start the measurement immediately after pipetting.

### Material:

- Fluorescein, 1 nM in 10 mM NaOH (Fluorescein sodium salt, Sigma)
- 10 mM NaOH = Blank (NaOH pellets)
- Greiner 96-well plate, flat bottom, black (for top measurement)
- Greiner 96-well plate, flat transparent bottom, black (for bottom measurement)
- Pipettes + tips

### Procedure:

Pipette 200  $\mu$ l for top and 350  $\mu$ l for bottom measurements of a 1 nM Fluorescein solution or the blank solution (10 mM NaOH) into the appropriate wells according to the plate layout.

### Plate Layout:

	1	2	3	4	5	6	7	8	9	10	11	12
A	F	B	F	B	F	B	F	B	F	B	F	B
B	F	B	F	B	F	B	F	B	F	B	F	B
C	F	B	F	B	F	B	F	B	F	B	F	B
D	F	B	F	B	F	B	F	B	F	B	F	B
E	F	B	F	B	F	B	F	B	F	B	F	B
F	F	B	F	B	F	B	F	B	F	B	F	B
G	F	B	F	B	F	B	F	B	F	B	F	B
H	F	B	F	B	F	B	F	B	F	B	F	B

F: 200/350  $\mu$ l 1 nM Fluorescein

B: 200/350  $\mu$ l Blank (10 mM NaOH)

## Measurement Parameters:

	Monochromator	Filter
<b>Measurement mode</b>	<b>Fluorescence Top/Bottom</b>	<b>Fluorescence Top/Bottom</b>
Excitation	485 nm	485 nm
Bandwidth excitation	20 nm	20 nm
Emission	535 nm	535 nm
Bandwidth emission	20 nm	25 nm
Flashes	30	30
Gain	Optimal	Optimal
Mirror	510 Dichroic	510 Dichroic
Z-position	Calculate from A1	Calculate from A1
Plate definition file	GRE96fb	GRE96fb

## Evaluation:

Calculate the detection limit (DL) as follows:

$$DL(pM) = \frac{(3 * SD_B * 1000)}{(\text{mean}_F - \text{mean}_B)}$$

SD <sub>B</sub>	Standard deviation of wells filled with Blank (10 mM NaOH)
1000	Concentration of Fluorescein in pM
mean <sub>F</sub>	Mean of wells filled with 1 nM Fluorescein
mean <sub>B</sub>	Mean of wells filled with Blank (10 mM NaOH)

### 12.15.3 Uniformity Top/Bottom 96-Well Plate

The uniformity defines the well-to-well variations when measuring a multi-well plate. The uniformity is calculated as percentage deviation from the mean value.

Before pipetting the plate, prepare the instrument for measurement and start the measurement immediately after pipetting.

#### Material:

- Fluorescence Standard Module: Fluorescein, 25 nM in 10 mM NaOH (Fluorescein sodium salt, Sigma)
- Fluorescence Enhanced Module: Fluorescein, 1 nM in 10 mM NaOH (Fluorescein sodium salt, Sigma)
- Greiner 96-well plate, flat bottom, black (for top measurement)
- Greiner 96-well plate, flat transparent bottom, black (for bottom measurement)
- Pipettes + tips

#### Procedure:

Pipette 200 µl of Fluorescein solution into the appropriate wells according to the plate layout.



### Plate Layout:

	1	2	3	4	5	6	7	8	9	10	11	12
A	F		F		F		F		F		F	
B	F		F		F		F		F		F	
C	F		F		F		F		F		F	
D	F		F		F		F		F		F	
E	F		F		F		F		F		F	
F	F		F		F		F		F		F	
G	F		F		F		F		F		F	
H	F		F		F		F		F		F	

F: 200 µl Fluorescein

### Measurement Parameters:

	Monochromator	Filter
<b>Measurement mode</b>	<b>Fluorescence Top/Bottom</b>	<b>Fluorescence Top/Bottom</b>
Excitation	485 nm	485 nm
Bandwidth excitation	20 nm	20 nm
Emission	535 nm	535 nm
Bandwidth emission	20 nm	25 nm
Flashes	30	30
Gain	Optimal	Optimal
Mirror	510 Dichroic	510 Dichroic
Z-position	Calculate from A1	Calculate from A1
Plate definition file	GRE96fb	GRE96fb

### Evaluation:

Calculate the Uniformity as follows:

$$\text{Uniformity (CV\%)} = \frac{SD_F * 100}{\text{mean}_F}$$

SD <sub>F</sub>	Standard deviation of wells filled with Fluorescein
mean <sub>F</sub>	Mean of wells filled with Fluorescein

### 12.15.4 Detection Limit Top/Bottom 384-Well Plate

The detection limit is the lowest quantity of a substance that can be distinguished from the blank within a stated confidence limit.

Before pipetting the plate, prepare the instrument for measurement and start the measurement immediately after pipetting.

### Material:

- Fluorescein, 1 nM in 10 mM NaOH (Fluorescein sodium salt, Sigma)
- 10 mM NaOH = Blank (NaOH pellets)
- Greiner 384-well plate, flat bottom, black (for top measurement)
- Greiner 384-well plate, flat transparent bottom, black (for bottom measurement)
- Pipettes + tips

### Procedure:

Pipette 100 µl of 1 nM Fluorescein solution or the blank solution (10 mM NaOH) into the appropriate wells according to the plate layout.

### Plate Layout:

	1	2	3	4	5	6	7	8	9	10	11	12	13	14	15	16	17	18	19	20	21	22	23	24	
A	F		B		F		B		F		B		F		B		F		B		F		B		
B																									
C	F		B		F		B		F		B		F		B		F		B		F		B		
D																									
E	F		B		F		B		F		B		F		B		F		B		F		B		
F																									
G	F		B		F		B		F		B		F		B		F		B		F		B		
H																									
I	F		B		F		B		F		B		F		B		F		B		F		B		
J																									
K	F		B		F		B		F		B		F		B		F		B		F		B		
L																									
M	F		B		F		B		F		B		F		B		F		B		F		B		
N																									
O	F		B		F		B		F		B		F		B		F		B		F		B		
P																									

F: 100 µl 1 nM Fluorescein  
B: 100 µl Blank (10 mM NaOH)

### Measurement Parameters

	Monochromator	Filter
<b>Measurement mode</b>	<b>Fluorescence Top/Bottom</b>	<b>Fluorescence Top/Bottom</b>
Excitation	485 nm	485 nm
Bandwidth excitation	20 nm	20 nm
Emission	535 nm	535 nm
Bandwidth emission	20 nm	25 nm
Flashes	30	30
Gain	Optimal	Optimal
Mirror	510 Dichroic	510 Dichroic
Z-position	Calculate from A1	Calculate from A1
Plate definition file	GRE384fb	GRE384fb

### Evaluation:

Calculate the detection limit (DL) as follows:

$$DL(pM) = \frac{(3 * SD_B * 1000)}{(mean_F - mean_B)}$$

SD <sub>B</sub>	Standard deviation of wells filled with Blank (10 mM NaOH)
1000	Concentration of Fluorescein in pM
mean <sub>F</sub>	Mean of wells filled with 1 nM Fluorescein
mean <sub>B</sub>	Mean of wells filled with Blank (10 mM NaOH)

### 12.15.5 Uniformity Top/Bottom 384-Well Plate

The uniformity defines the well-to-well variations when measuring a multi-well plate. The uniformity is calculated as percentage deviation from the mean value.

Before pipetting the plate, prepare the instrument for measurement and start the measurement immediately after pipetting.

#### Material:

- Fluorescence: Fluorescein, 25 nM in 10 mM NaOH (Fluorescein sodium salt, Sigma)
- Greiner 384-well plate, flat bottom, black (for top measurement)
- Greiner 384-well plate, flat transparent bottom, black (for bottom measurement)
- Pipettes + tips

#### Procedure:

Pipette 100 µl of Fluorescein solution into the appropriate wells according to the plate layout.

#### Plate Layout:

	1	2	3	4	5	6	7	8	9	10	11	12	13	14	15	16	17	18	19	20	21	22	23	24
A	F				F				F				F				F				F			
B																								
C	F				F				F				F				F				F			
D																								
E	F				F				F				F				F				F			
F																								
G	F				F				F				F				F				F			
H																								
I	F				F				F				F				F				F			
J																								
K	F				F				F				F				F				F			
L																								
M	F				F				F				F				F				F			
N																								
O	F				F				F				F				F				F			
P																								

F: 100 µl Fluorescein

## Measurement Parameters

	Monochromator	Filter
<b>Measurement mode</b>	<b>Fluorescence Top/Bottom</b>	<b>Fluorescence Top/Bottom</b>
Excitation	485 nm	485 nm
Bandwidth excitation	20 nm	20 nm
Emission	535 nm	535 nm
Bandwidth emission	20 nm	25 nm
Flashes	30	30
Gain	Optimal	Optimal
Mirror	510 Dichroic	510 Dichroic
Z-position	Calculate from A1	Calculate from A1
Plate definition file	GRE384fb	GRE384fb

### Evaluation:

Calculate the Uniformity as follows:

$$\text{Uniformity (CV\%)} = \frac{SD_F * 100}{\text{mean}_F}$$

SD <sub>F</sub>	Standard deviation of wells filled with Fluorescein
mean <sub>F</sub>	Mean of wells filled with Fluorescein

## 12.15.6 Detection Limit Top/Bottom 1536-Well Plate

The detection limit is the lowest quantity of a substance that can be distinguished from the blank within a stated confidence limit.

Before pipetting the plate, prepare the instrument for measurement and start the measurement immediately after pipetting.

### Material:

- Fluorescein, 1 nM in 10 mM NaOH (Fluorescein sodium salt, Sigma)
- 10 mM NaOH = Blank (NaOH pellets)
- Greiner 1536-well plate, flat bottom, black (for top measurement)
- Greiner 1536-well plate, flat transparent bottom, black (for bottom measurement)
- Pipettes + tips

### Procedure:

Pipette 10 µl of 1 nM Fluorescein solution or the blank solution (10 mM NaOH) into the appropriate wells according to the plate layout.

## Plate Layout:

	1	...	5	...	9	...	13	...	17	...	21	...	25	...	29	...	33	...	37	...	41	...	45	...
A	F		B		F		B		F		B		F		B		F		B		F		B	
...																								
E	F		B		F		B		F		B		F		B		F		B		F		B	
...																								
I	F		B		F		B		F		B		F		B		F		B		F		B	
...																								
M	F		B		F		B		F		B		F		B		F		B		F		B	
...																								
Q	F		B		F		B		F		B		F		B		F		B		F		B	
...																								
U	F		B		F		B		F		B		F		B		F		B		F		B	
...																								
Y	F		B		F		B		F		B		F		B		F		B		F		B	
...																								
AC	F		B		F		B		F		B		F		B		F		B		F		B	
...																								
AF																								

F: 10 µl 1 nM Fluorescein  
 B: 10 µl Blank (10 mM NaOH)

## Measurement Parameters

	Monochromator	Filter
<b>Measurement mode</b>	<b>Fluorescence Top/Bottom</b>	<b>Fluorescence Top/Bottom</b>
Excitation	485 nm	485 nm
Bandwidth excitation	20 nm	20 nm
Emission	535 nm	535 nm
Bandwidth emission	20 nm	25 nm
Flashes	30	30
Gain	Optimal	Optimal
Mirror	510 Dichroic	510 Dichroic
Z-position	Calculate from A1	Calculate from A1
Plate definition file	GRE1536fb	GRE1536fb

## Evaluation:

Calculate the detection limit (DL) as follows:

$$DL(pM) = \frac{(3 * SD_B * 1000)}{(\text{mean}_F - \text{mean}_B)}$$

SD <sub>B</sub>	Standard deviation of wells filled with Blank (10 mM NaOH)
1000	Concentration of Fluorescein in pM
mean <sub>F</sub>	Mean of wells filled with 1 nM Fluorescein
mean <sub>B</sub>	Mean of wells filled with Blank (10 mM NaOH)

## 12.15.7 Uniformity Top/Bottom 1536-Well Plate

The uniformity defines the well-to-well variations when measuring a multi-well plate. The uniformity is calculated as percentage deviation from the mean value.

Before pipetting the plate, prepare the instrument for measurement and start the measurement immediately after pipetting.

### Material:

- Fluorescein, 100 nM in 10 mM NaOH (Fluorescein sodium salt, Sigma)
- Greiner 1536-well plate, flat bottom, black (for top measurement)
- Greiner 1536-well plate, flat transparent bottom, black (for bottom measurement)
- Pipettes + tips

### Procedure:

Pipette 10 µl of 100 nM Fluorescein solution into the appropriate wells according to the plate layout.

### Plate Layout:

	1	...	5	...	9	...	13	...	17	...	21	...	25	...	29	...	33	...	37	...	41	...	45	...
A	F				F				F				F				F				F			
...																								
E	F				F				F				F				F				F			
...																								
I	F				F				F				F				F				F			
...																								
M	F				F				F				F				F				F			
...																								
Q	F				F				F				F				F				F			
...																								
U	F				F				F				F				F				F			
...																								
Y	F				F				F				F				F				F			
...																								
AC	F				F				F				F				F				F			
...																								
AF																								

F: 10 µl 100 nM Fluorescein

### Measurement Parameters

	Monochromator	Filter
<b>Measurement mode</b>	<b>Fluorescence Top/Bottom</b>	<b>Fluorescence Top/Bottom</b>
Excitation	485 nm	485 nm
Bandwidth excitation	20 nm	20 nm
Emission	535 nm	535 nm
Bandwidth emission	20 nm	25 nm
Flashes	30	30
Gain	Optimal	Optimal
Mirror	510 Dichroic	510 Dichroic

	Monochromator	Filter
<b>Measurement mode</b>	<b>Fluorescence Top/Bottom</b>	<b>Fluorescence Top/Bottom</b>
Z-position	Calculate from A1	Calculate from A1
Plate definition file	GRE1536fb	GRE1536fb

### Evaluation:

Calculate the Uniformity as follows:

$$\text{Uniformity (CV\%)} = \frac{SD_F * 100}{\text{mean}_F}$$

SD <sub>F</sub>	Standard deviation of wells filled with Fluorescein
mean <sub>F</sub>	Mean of wells filled with Fluorescein

### 12.15.8 Detection Limit TRF 96-Well Plate

The detection limit is the lowest quantity of a substance that can be distinguished from the blank within a stated confidence limit.

Before pipetting the plate, prepare the instrument for measurement and start the measurement immediately after pipetting.

#### Material:

- Europium, 1 nM (HVD Life Sciences)
- Enhancement Solution = Blank (HVD Life Sciences)
- Greiner 96-well plate, flat bottom, white
- Pipettes + tips

#### Procedure:

Pipette 200 µl of 1 nM Europium solution or the blank solution (Enhancement Solution) into the appropriate wells according to the plate layout. Dilute the Europium solution 10 times by using the Enhancement Solution when testing the filter system (0.1 nM Europium solution).

#### Plate Layout:

	1	2	3	4	5	6	7	8	9	10	11	12
A	Eu	B	B	B	B	B						
B	Eu	B	B	B	B	B						
C	Eu	B	B	B	B	B						
D	Eu	B	B	B	B	B						
E	Eu	B	B	B	B	B						
F	Eu	B	B	B	B	B						
G	Eu	B	B	B	B	B						
H	Eu	B	B	B	B	B						

Eu: 200 µl 1 nM Europium (Monochromator) / 0.1 nM Europium (Filter)  
 B: 200 µl Blank (Enhancement Solution)

## Measurement Parameters:

	Monochromator	Filter
<b>Measurement mode</b>	<b>Time Resolved Fluorescence</b>	<b>Time Resolved Fluorescence</b>
Excitation	340 nm	340 nm
Bandwidth excitation	Standard Module: 20 nm Enhanced Module: 30 nm	35 nm
Emission	617 nm	612 nm
Bandwidth emission	20 nm	10 nm
Flashes	30	30
Gain	Optimal	Optimal
Mirror	510 Dichroic	510 Dichroic
Z-position	Calculate from A1	Calculate from A1
Integration time	400 µs	400 µs
Lag time	100 µs	100 µs
Plate definition file	GRE96fw	GRE96fw

## Evaluation:

Calculate the detection limit (DL) as follows:

$$DL(fM) = \frac{(3 * SD_B * 10^6)}{(\text{mean}_F - \text{mean}_B)}$$

SDB	Standard deviation of wells filled with Blank (Enhancement Solution)
10 <sup>6</sup>	Concentration of Europium in fM (change to 10 <sup>5</sup> in case of 0.1 nM Europium)
meanF	Mean of wells filled with Europium
meanB	Mean of wells filled with Blank (Enhancement Solution)

## 12.15.9 Detection Limit TRF 384-Well Plate

The detection limit is the lowest quantity of a substance that can be distinguished from the blank within a stated confidence limit.

Before pipetting the plate, prepare the instrument for measurement and start the measurement immediately after pipetting.

### Material:

- Europium, 1 nM (HVD Life Sciences)
- Enhancement Solution = Blank (HVD Life Sciences)
- Greiner 384-well plate, flat bottom, white
- Pipettes + tips

### Procedure:

Pipette 100 µl of 1 nM Europium solution or the blank solution (Enhancement Solution) into the appropriate wells according to the plate layout. Dilute the Europium solution 10 times by using the Enhancement Solution when testing the filter system (0.1 nM Europium solution).



**Plate Layout:**

	1	2	3	4	5	6	7	8	9	10	...	24
A	Eu	B	B	B	B	B						
B	Eu	B	B	B	B	B						
C	Eu	B	B	B	B	B						
D	Eu	B	B	B	B	B						
E	Eu	B	B	B	B	B						
F	Eu	B	B	B	B	B						
...												
P												

Eu: 100 µl 1 nM Europium (Monochromator) / 0.1 nM Europium (Filter)  
 B: 100 µl Blank (Enhancement Solution)

**Measurement Parameters:**

	Monochromator	Filter
<b>Measurement mode</b>	<b>Time Resolved Fluorescence</b>	<b>Time Resolved Fluorescence</b>
Excitation	340 nm	340 nm
Bandwidth excitation	Standard Module: 20 nm Enhanced Module: 30 nm	35 nm
Emission	617 nm	612 nm
Bandwidth emission	20 nm	10 nm
Flashes	30	30
Gain	Optimal	Optimal
Mirror	510 Dichroic	510 Dichroic
Z-position	Calculate from A1	Calculate from A1
Integration time	400 µs	400 µs
Lag time	100 µs	100 µs
Plate definition file	GRE384fw	GRE384fw

### Evaluation:

Calculate the detection limit (DL) as follows:

$$DL(\text{fM}) = \frac{(3 * SD_B * 10^6)}{(\text{mean}_F - \text{mean}_B)}$$

SD <sub>B</sub>	Standard deviation of wells filled with Blank (Enhancement Solution)
10 <sup>6</sup>	Concentration of Europium in fM (change to 10 <sup>5</sup> in case of 0.1 nM Europium)
mean <sub>F</sub>	Mean of wells filled with Europium
mean <sub>B</sub>	Mean of wells filled with Blank (Enhancement Solution)

### 12.15.10 Detection Limit TRF 1536-Well Plate

The detection limit is the lowest quantity of a substance that can be distinguished from the blank within a stated confidence limit.

Before pipetting the plate, prepare the instrument for measurement and start the measurement immediately after pipetting.

#### Material:

- Europium, 1 nM (HVD Life Sciences)
- Enhancement Solution = Blank (HVD Life Sciences)
- Greiner 1536-well plate, flat bottom, white
- Pipettes + tips

#### Procedure:

Pipette 10 µl of 1 nM Europium solution or the blank solution (Enhancement Solution) into the appropriate wells according to the plate layout. Dilute the Europium solution 10 times by using the Enhancement Solution when testing the filter system (0.1 nM Europium solution).

#### Plate Layout:

	1	2	3	4	5	6	7	8	9	10	11	12	13	14	15	16	17	18	19	20	21	22	...	48	
A	Eu	B	B	B	B	B	B	B	B	B	B	B	B	B	B	B	B								
B	Eu	B	B	B	B	B	B	B	B	B	B	B	B	B	B	B	B								
C	Eu	B	B	B	B	B	B	B	B	B	B	B	B	B	B	B	B								
D																									
E																									
F																									
G																									
H																									
I																									
J																									
K																									
L																									
M																									
N																									
...																									
AF																									

Eu: 10 µl 1 nM Europium (Monochromator) / 0.1 nM Europium (Filter)  
 B: 10 µl Blank (Enhancement Solution)

### Measurement Parameters:

	Monochromator	Filter
<b>Measurement mode</b>	<b>Time Resolved Fluorescence</b>	<b>Time Resolved Fluorescence</b>
Excitation	340 nm	340 nm
Bandwidth excitation	Standard Module: 20 nm Enhanced Module: 30 nm	35 nm
Emission	617 nm	612 nm
Bandwidth emission	20 nm	10 nm
Flashes	30	30
Gain	Optimal	Optimal
Mirror	510 Dichroic	510 Dichroic
Z-position	Calculate from A1	Calculate from A1
Integration time	400 µs	400 µs
Lag time	100 µs	100 µs
Plate definition file	GRE1536fw	GRE1536fw

### Evaluation:

Calculate the detection limit (DL) as follows:

$$DL(\text{fM}) = \frac{(3 * SD_B * 10^6)}{(\text{mean}_F - \text{mean}_B)}$$

SD <sub>B</sub>	Standard deviation of wells filled with Blank (Enhancement Solution)
10 <sup>6</sup>	Concentration of Europium in fM (change to 10 <sup>5</sup> in case of 0.1 nM Europium)
mean <sub>F</sub>	Mean of wells filled with Europium
mean <sub>B</sub>	Mean of wells filled with Blank (Enhancement Solution)

### 12.15.11 Fluorescence Polarization Precision 96-Well Plate

This procedure is for filter-based devices only. The fluorescence polarization precision corresponds to the standard deviation of the mP (milli-polarization) values of the wells filled with fluorescein.

Before pipetting the plate, prepare the instrument for measurement and start the measurement immediately after pipetting.

#### Material:

- Fluorescein, 1 nM in 10 mM NaOH (Fluorescein sodium salt, Sigma)
- 10 mM NaOH = Blank (NaOH pellets)
- Greiner 96-well plate, flat bottom, black
- Pipettes + tips

#### Procedure:

Pipette 200 µl of 1 nM Fluorescein solution or the blank solution (10 mM NaOH) into the appropriate wells according to the plate layout.

### Plate Layout:

	1	2	3	4	5	6	7	8	9	10	11	12
A	F	B	F	B	F	B	F	B	F	B	F	B
B	F	B	F	B	F	B	F	B	F	B	F	B
C	F	B	F	B	F	B	F	B	F	B	F	B
D	F	B	F	B	F	B	F	B	F	B	F	B
E	F	B	F	B	F	B	F	B	F	B	F	B
F	F	B	F	B	F	B	F	B	F	B	F	B
G	F	B	F	B	F	B	F	B	F	B	F	B
H	F	B	F	B	F	B	F	B	F	B	F	B

F: 200 µl 1 nM Fluorescein  
 B: 200 µl Blank (10 mM NaOH)

### Measurement Parameters

	Filter
Measurement mode	Fluorescence Polarization
Excitation	485 nm
Bandwidth excitation	20 nm
Emission	535 nm
Bandwidth emission	25 nm
Flashes	30
Gain	Optimal
Mirror	510 Dichroic
Z-position	Calculate from A1
Settle time	300 ms
G-factor	Calculate
Reference G-factor from/to	A1-H1
Reference Blank G-factor from/to	A2-H2
Measurement blank	Remaining wells filled with Blank
Plate definition file	GRE96fb

### Evaluation:

Calculate the precision:

$$\text{Precision (mP)} = 1 * SD_F$$

SD<sub>F</sub>

Standard deviation of mP values of wells filled with Fluorescein

## 12.15.12 Fluorescence Polarization Precision 384-Well Plate

This procedure is for filter-based devices only. The fluorescence polarization precision corresponds to the standard deviation of the mP (milli-polarization) values of the wells filled with fluorescein.

Before pipetting the plate, prepare the instrument for measurement and start the measurement immediately after pipetting.

### Material:

- Fluorescein, 1 nM in 10 mM NaOH (Fluorescein sodium salt, Sigma)
- 10 mM NaOH = Blank (NaOH pellets)
- Greiner 384-well plate, flat bottom, black
- Pipettes + tips

### Procedure:

Pipette 100  $\mu$ l of 1 nM Fluorescein solution or the blank solution (10 mM NaOH) into the appropriate wells according to the plate layout.

### Plate Layout:

	1	2	3	4	5	6	7	8	9	10	11	12	13	14	15	16	17	18	19	20	21	22	23	24
A	F		B		F		B		F		B		F		B		F		B		F		B	
B																								
C	F		B		F		B		F		B		F		B		F		B		F		B	
D																								
E	F		B		F		B		F		B		F		B		F		B		F		B	
F																								
G	F		B		F		B		F		B		F		B		F		B		F		B	
H																								
I	F		B		F		B		F		B		F		B		F		B		F		B	
J																								
K	F		B		F		B		F		B		F		B		F		B		F		B	
L																								
M	F		B		F		B		F		B		F		B		F		B		F		B	
N																								
O	F		B		F		B		F		B		F		B		F		B		F		B	
P																								

F: 100  $\mu$ l 1 nM Fluorescein

B: 100  $\mu$ l Blank (10 mM NaOH)

### Measurement Parameters:

	Filter
Measurement mode	Fluorescence Polarization
Excitation	485 nm
Bandwidth excitation	20 nm
Emission	535 nm
Bandwidth emission	25 nm
Flashes	30
Gain	Optimal
Mirror	510 Dichroic
Z-position	Calculate from A1
G-factor	Calculate
Reference G-factor from/to	A1, C1, E1, G1, I1, K1, M1, O1;
Reference Blank G-factor from/to	A3, C3, E3, G3, I3, K3, M3, O3;
Measurement blank	Remaining wells filled with Blank
Plate definition file	GRE384fb

### Evaluation:

Calculate the precision:

$$\text{Precision (mP)} = 1 * SD_F$$

SD <sub>F</sub>	Standard deviation of mP values of wells filled with Fluorescein
-----------------	--

### 12.15.13 Fluorescence Polarization Precision 1536-Well Plate

This procedure is for filter-based devices only. The fluorescence polarization precision corresponds to the standard deviation of the mP (milli-polarization) values of the wells filled with fluorescein.

Before pipetting the plate, prepare the instrument for measurement and start the measurement immediately after pipetting.

#### Material:

- Fluorescein, 1 nM in 10 mM NaOH (Fluorescein sodium salt, Sigma)
- 10 mM NaOH = Blank (NaOH pellets)
- Greiner 1536-well plate, flat bottom, black
- Pipettes + tips

#### Procedure:

Pipette 10 µl of 1 nM Fluorescein solution or the blank solution (10 mM NaOH) into the appropriate wells according to the plate layout.

#### Plate Layout:

	1	...	5	...	9	...	13	...	17	...	21	...	25	...	29	...	33	...	37	...	41	...	45	...
A	F		B		F		B		F		B		F		B		F		B		F		B	
...																								
E	F		B		F		B		F		B		F		B		F		B		F		B	
...																								
I	F		B		F		B		F		B		F		B		F		B		F		B	
...																								
M	F		B		F		B		F		B		F		B		F		B		F		B	
...																								
Q	F		B		F		B		F		B		F		B		F		B		F		B	
...																								
U	F		B		F		B		F		B		F		B		F		B		F		B	
...																								
Y	F		B		F		B		F		B		F		B		F		B		F		B	
...																								
AC	F		B		F		B		F		B		F		B		F		B		F		B	
...																								
AF																								

F: 10 µl 1 nM Fluorescein

B: 10 µl Blank (10 mM NaOH)

### Measurement Parameters:

	Filter
Measurement mode	Fluorescence Polarization
Excitation	485 nm
Bandwidth excitation	20 nm
Emission	535 nm
Bandwidth emission	25 nm
Flashes	30
Gain	Optimal
Mirror	510 Dichroic
Z-position	Calculate from A1
G-factor	Calculate
Reference G-factor from/to	A1;
Reference Blank G-factor from/to	A5;
Measurement blank	Remaining wells filled with Blank
Plate definition file	GRE1536fb

### Evaluation:

Calculate the precision:

$$\text{Precision (mP)} = 1 * SD_F$$

SD <sub>F</sub>	Standard deviation of mP values of wells filled with Fluorescein
-----------------	--



## 13 Cell Module

Tecan's cell module is based upon the bright-field illumination technique which is a commonly used tool for visualization of cells. Bright-field cellular visualization requires a difference in contrast between cells and their surrounding medium. This contrast is caused by the different levels of light absorption of cells and their media. Counting of cells with low or no contrast can be improved by using various staining procedures.

### 13.1 Measurement Techniques

#### 13.1.1 Cell Counting/Cell Viability

Tecan provides two fully-automated apps for counting cells and determining cell viability in single-use cell chips. Both apps are optimized to perform a routine quality check of cell cultures on a daily basis.

#### 13.1.2 Cell Confluence

Confluence indicates the size of surface covered by adherent cells. Cell confluence is displayed in percentage of the measured area. Confluence measurements can be performed in cell culture plates from 6- to 96-well format.

### 13.2 Bright-field Imaging

The cell module consists of an illumination module and a camera module. Samples are illuminated from the top and image acquisition is done from the bottom.

#### 13.2.1 Optics

The illumination module consists of an LED (light emitting diode), an aperture wheel, and a lens system. An LED serves as the light source [1]. The light beam is shaped by apertures of the aperture wheel and the lens system [2] guides the bundled light to the sample.

The camera module consists of an objective, a camera and a laser diode. The light is collected by an objective and reflected to the camera [3] by a mirror [4]. The laser diode [5] is used for autofocusing.

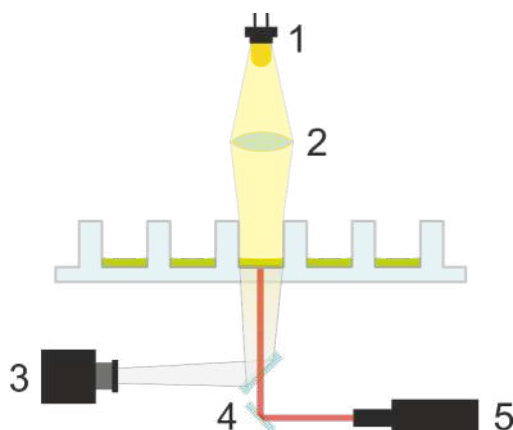

Figure 62: Cell counting optics  
LED [1], lens system [2], camera [3], mirror [4], laser diode [5]

The cell module uses a laser diode for auto-focusing. A SPARK instrument equipped with a cell module is a LASER CLASS 1 product. The instrument complies with FDA radiation performance standards, 21 CFR 1040.10, except for deviations pursuant to Laser Notice No. 50, dated June 24, 2007.

The following labels are attached to the rear of the instrument:



Complies with 21 CFR 1040.10  
except for deviations pursuant to  
Laser Notice No. 50,  
dated June 24, 2007

### 13.2.2 Detection

Basically, the counting and confluence procedure involves focusing, light exposure timing and image acquisition. An automatic laser-based focusing system enables precise autofocusing.

## 13.3 Measurements Equipment

### 13.3.1 Cell Chips

Tecan provides appropriate single-use cell chips consisting of two sample chambers each (see picture below). The filling volume for one sample chamber is 10  $\mu$ l and can be filled using an appropriate standard pipette. For optimal performance, avoid the formation of air bubbles in the sample chamber during the filling procedure.

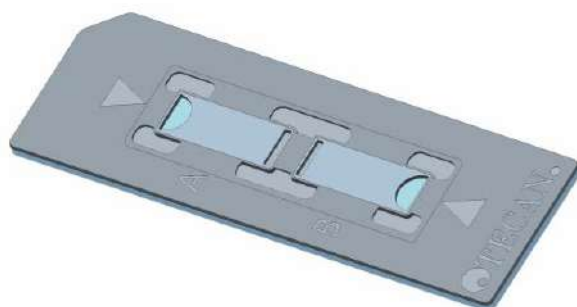

Figure 63: Cell chip



**CAUTION:** Proper performance can only be guaranteed if Tecan's cell chips are used for cell counting and cell viability analysis. Avoid the formation of air bubbles when filling the sample chambers of the cell chip.



**CAUTION:** Before using the cell chips control their date of expiry. Optimal performance is not guaranteed if expiry date is exceeded.

### 13.3.2 Adapter for Cell Chips

Tecan's cell chip adapter is designed to hold up to four cell chips. The cell chips have cropped corners to prevent incorrect insertion and avoid wrong data acquisition. The slides must be inserted correctly for the adapter to close properly. The lid is automatically secured by a magnetic mechanism. The denotation (e.g. A1, A2) of the sample positions on the adapter corresponds to the those presented in the software. Before starting measurements, make sure that the cell chip adapter is inserted correctly. The opening must be in front and chamber A1 must be on the upper left side.

The adapter can be cleaned by using 70 % ethanol.



Figure 64: Cell chip adapter



**CAUTION:** Before starting measurements, make sure that the cell chip adapter is inserted correctly. The opening must be in front and chamber A1 must be on the upper left side.

### 13.3.3 Maintenance and Cleaning of the Cell Chip Adapter

The cell chip adapter can be cleaned by applying the following procedure:

1. Wear protective gloves, protective glasses and protective clothing.
2. Empty the cell chip adapter and carefully remove the springs installed on the inside of the adapter lid (see Figure 64: Cell chip adapter).
3. Carefully wipe all outside surfaces of the adapter and the springs with a lint-free paper towel soaked with 70 % ethanol.
4. Allow to dry.
5. Reinstall springs before using the adapter.



**CAUTION:** Don't use the cell chip adapter without springs! Measurement errors may result.

## 13.4 Defining Cell Counting & Confluence Measurements

The SparkControl software provides two separate strips for measuring:

- Cell Counting
- Cell Confluence

The availability of the strips depends on the configuration of the instrument connected.

### 13.4.1 Cell Counting Strip

This strip is used for cell counting measurements in the Tecan cell chip adapter.

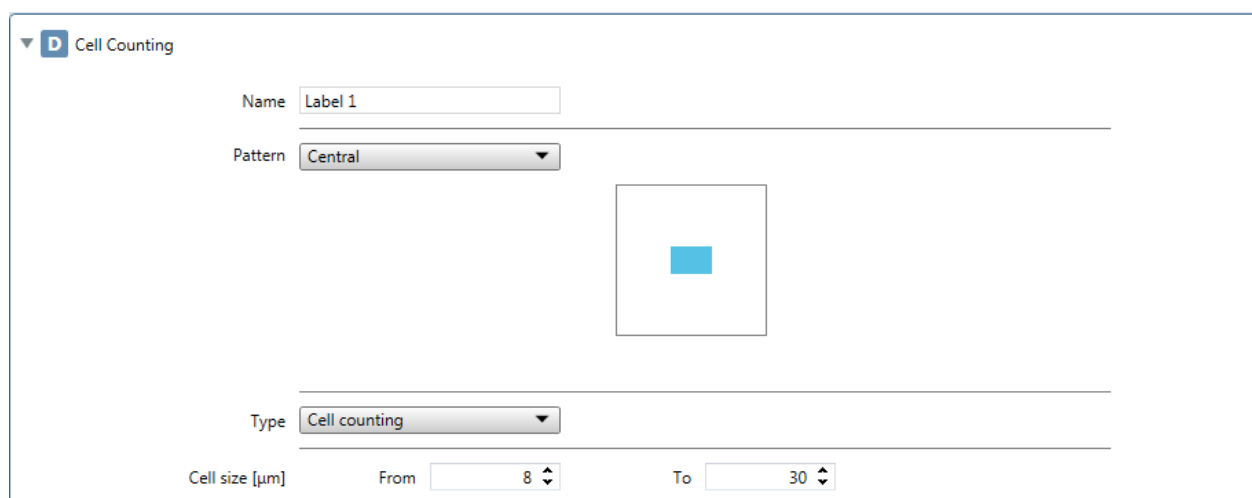

Figure 65: Cell Counting strip

The **Cell Counting** strip includes the following elements:

<b>Name</b>	Define a label name.
<b>Type</b>	Select <b>Cell counting</b> or <b>Cell viability</b>
<b>Pattern</b>	Select <b>Center</b> to acquire an image in the center of a chamber. Select <b>Whole well</b> to acquire images within the whole chamber area. Select <b>User defined</b> and define positions within a chamber.
<b>Cell size [µm]</b>	Define the cell size of the counted cells.

## 13.4.2 Cell Confluence Strip

This strip is used for cell confluence measurements.

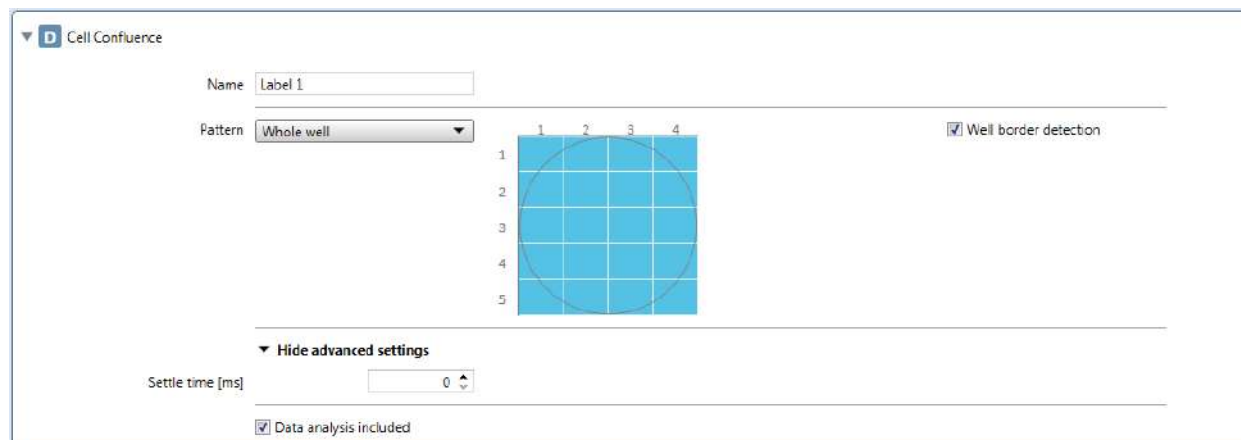

Figure 66: Cell Confluence strip

The **Cell Confluence** strip includes the following elements:

<b>Name</b>	Define a label name.
<b>Pattern</b>	Select <b>Center</b> to acquire an image in the center of a well. Select <b>Whole well</b> to acquire images within the whole well. To detect the well border, perform measurements with <b>Well border detection</b> selected. Select <b>User defined</b> and define positions within a well without intersections with the well border. It is possible to define only the area within the well without the well border intersection.
<b>Settle time [ms]</b>	Define a time delay between a plate movement and the start of signal integration. Enter a value within the valid instrument range.
<b>Data analysis included</b>	If selected (default settings), the acquired images are analysed and the results available for the user.
<b>Show advanced settings</b>	Click this expand button to access the following parameters: <b>Settle time</b> and <b>Data analysis included</b> .

## 13.4.3 Measurement Mode

Cell counting measurements can be defined and performed plate-wise only as

- Single-label endpoint measurements
- Multi-label endpoint measurements

Cell confluence measurements can be defined and performed as

- Single-label endpoint and kinetic measurements
- Multi-label endpoint and kinetic measurements

All measurements can be carried out plate-wise and well-wise.

## 13.5 Cell Counting Application

Tecan provides two ready-to-use cell counting apps for

- Cell counting
- Cell viability

When using these apps, the calculation of the cell concentration, cell size, and viability values are performed automatically.

## 13.6 Optimizing Cell Counting Measurements

### 13.6.1 Increase Number of Images

In general, cell counting and cell viability is performed in very small volumes. Cell concentrations below  $1 \times 10^5$  cells/ml result in a low number of counted objects per image and often an irregular distribution of the cells. To improve counting rates and therefore absolute numbers of cells/ml, more than one image per sample can be taken and analyzed using the cell counting and cell viability apps. Choose between 4 and 8 images/sample.



**CAUTION:** Be aware that measurements with more than one image per sample may take more time. Make sure that the sample chambers do not dry out during the measurement procedure!

## 13.7 Optimizing Cell Confluence Measurements

### 13.7.1 Use the Well Border Detection

Confluence detection requires exact plate transport movements and positioning. To compensate for plate dimension variances activate the Well Border Detection function in the software. This option allows for accurate confluence analysis of adherent cells up to the well border. Without Well Border Detection function contrast changes in the field of the well border will be included into data analysis resulting in false confluence values.



**CAUTION:** Be aware that measurements including Well Border Detection take more time.

## 13.8 Cell Module Specifications



**NOTE:** All specifications are subject to change without prior notification.

### 13.8.1 General Specifications

Illumination	LED
Image	Bright-field
Objective	4 x
Optical resolution	> 3 $\mu$ m
Area/image	2.2 mm <sup>2</sup>

### 13.8.2 Specifications Cell Counting/Viability

Disposable	Cell chips (Tecan brand)
Cell chips	2 Sample chambers per cell chip
Adapter for cell chips	4 Cell chips per adapter
Multiple images per sample	1, 4, 8
Cell size	4-90 $\mu$ m
Cell concentration	1x10 <sup>4</sup> -1x10 <sup>7</sup> cells/ml
Reproducibility	< 10% (1 Sigma), HeLa and CHO cell lines
Accuracy	$\pm$ 10%, at 1x10 <sup>6</sup> cells/ml, HeLa and CHO cell lines

### 13.8.3 Measurement Time

Plate-in and plate-out movements as well as initialization steps are not included in the measurement time.

Measurement Technique	Measurement Time
Cell counting/viability check	< 30 seconds/sample
Confluence, 96-well, whole well imaging	< 45 minutes

## 13.9 Quality Control of Cell Counting

### 13.9.1 Periodic Quality Control Tests

Depending on usage and application we recommend a periodic evaluation of the instrument on site at Tecan.

The tests described in the following chapter does not replace a full evaluation by the manufacturer or authorized dealers. But the tests may be performed periodically by the user to check significant aspects of the instrument performance.

The results are strongly influenced by errors in pipetting and the setting of the parameters in the instrument. Therefore please follow the instructions carefully. The user should determine the appropriate intervals for this testing based on how frequently the instrument is operated.



**CAUTION:** Before starting measurements, make sure that the Tecan Adapter for Cell Chips is inserted correctly. The position of chamber A1 has to be on the upper left side.



**WARNING:** The following instructions explain how to perform the Quality Control to check the specifications of the instrument. If the results of these control tests do not conform to the specifications of the instrument given in this manual, please contact your local service center for further advice.



## 13.9.2 Cell Counting Accuracy

Accuracy is the ability of a system to give responses close to a true value. The accuracy is calculated as percentage deviation from the true value.

### Material:

- Cell suspension, approx.  $1 \times 10^6$  cells/ml
- Tecan Cell Chip
- Tecan Adapter for Cell Chips
- Cell counting chamber for manual counting (e.g. Neubauer chamber)
- Pipette and tips (10  $\mu$ l)

### Procedure:

Adjust the cell suspension to a concentration of approximately  $1 \times 10^6$  cells/ml. Perform manual counting of cell suspension with, for example, a Neubauer chamber. Pipette 10  $\mu$ l of cell suspension into the counting chambers (chamber A and B) of a Tecan Cell Chip and load the cell chip into the adapter (position 1). Start the Cell counting application.

### Measurement Parameters:

Measurement	Cell counting app
Position	A1, B1 (define as duplicates)
Cell size	Depends on cell line
Images	4

### Evaluation:

Calculate difference between cell concentration (cells/ml) obtained from manual counting and automated counting and calculate the accuracy as follows:

$$\text{Accuracy (\%)} = \frac{\text{concentration}_{\text{manual}} - \text{concentration}_{\text{automated}}}{(\text{concentration}_{\text{manual}}/100)}$$

Accuracy data were collected by using HeLa and CHO cell lines. Cell lines with varying characteristics may not result in the same accuracy data.



## 14 Injectors

The injector module consists of one or two syringes contained in external units with lightproof covers. There are two standard syringe volumes, 500  $\mu\text{l}$  and 1000  $\mu\text{l}$ . The injector needles are designed to inject liquid into any well of a 1 to 384-well microplate that complies with SBS standards (with the exception of small volume 384-well plates).

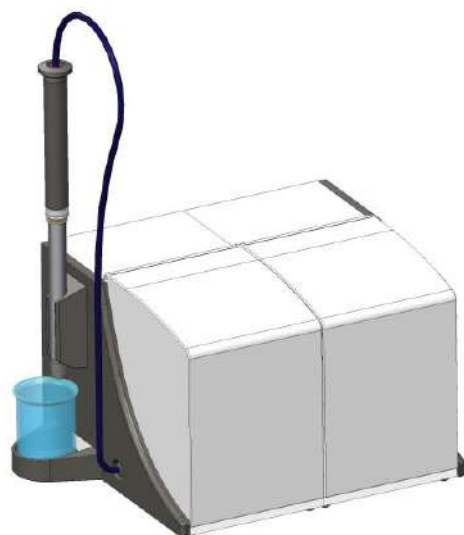

Figure 67: Injector module consisting of two injector boxes



**CAUTION:** Switch off the instrument before plugging in or unplugging the injector module.

## 14.1 Injector Carrier

The injector carrier can be easily removed (by the customer) from the instrument for actions such as injector priming, rinsing or optimizing injection speed.

When using the injector during a measurement procedure, the injector carrier must be inserted correctly into the instrument. Remove the injector dummy and insert the injector carrier into the injector port. Press the injector carrier gently into the port to lock it in place.

The instrument is equipped with an injector sensor that checks the position of the injector carrier. If the injector is inserted into the instrument incorrectly, the sensor will not recognize the inserted injector carrier and injection will be disabled; however, actions such as rinsing and priming will remain enabled.

Performing rinse or prime procedures with an incorrectly inserted injector carrier can damage the instrument. Therefore, always make sure that the injector carrier is in the service position for rinsing and priming (see figure below).

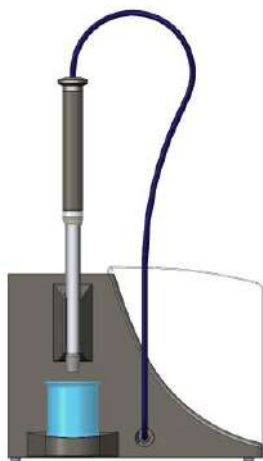

Figure 68: Injector carrier in service position



**CAUTION:** Never touch the syringes during operation.



**CAUTION:** The injector carrier must be in the service position for rinsing and priming. Do not perform rinse or prime procedures if the injector is inserted in the instrument. Performing rinse or prime procedures with an incorrectly inserted injector carrier can damage the instrument.



**CAUTION:** The injector carrier must be inserted correctly into the injector port, otherwise the injector will not be detected and prime and rinse functions will remain enabled. Performing rinse or prime procedures with an incorrectly inserted injector carrier can damage the instrument.

The injection speed can be adjusted via the software. The optimal injection speed is dependent on the assay characteristics, such as the plate format and the viscosity and measuring behavior of the liquids.

The removable injector carrier makes it possible to optimize this process outside of the instrument where a visual inspection can be easily performed.

### 14.1.1 Injector Dummy

All instruments possessing injector ports (instruments with injectors or instruments prepared to be upgraded for injectors) are delivered with injector dummies. The injector dummy replaces the injector if the injector itself is not in use. In such cases, the injector dummy ensures that the desired atmosphere in the instrument remains stable (temperature, gas concentration).

Always reinsert the injector dummy into the injector port after the injector carrier has been removed. Press the injector dummy gently into the port to lock it in place and close the lid. The injector dummy activates the injector sensor only if it is positioned correctly in the injector port.



**CAUTION:** Make sure that the injector dummy is inserted in the injector port every time the injector is not in use.



**CAUTION:** Be aware that the injector dummy also activates the injector sensor if correctly inserted into the injector port. Injection steps can be performed with the injector dummy inserted, however the results will be unusable.

### 14.1.2 Storage Bottles and Bottle Holders

One injector box can accommodate a storage bottle up to 125 ml volume. The standard bottle set for each injector box consist of one 125 ml and one 15 ml bottle. Each injector box includes a bottle holder designed for different sizes and volumes. The bottles and tubes containing the fluids that are to be injected can be attached securely to the holder using flexible PVC clasps. The tubes from the injector syringe can be inserted into a carbon needle that reaches down to the bottom of the flask to ensure the optimal aspiration of even small volumes of fluid (see Figure 70: Bottle holders).

If not in use the carbon needle carrying the tubes can be easily stored inside the injector box. To avoid any liquid drops in the injector box, the storage position of the needle is equipped with a liquid collection container (1 ml).

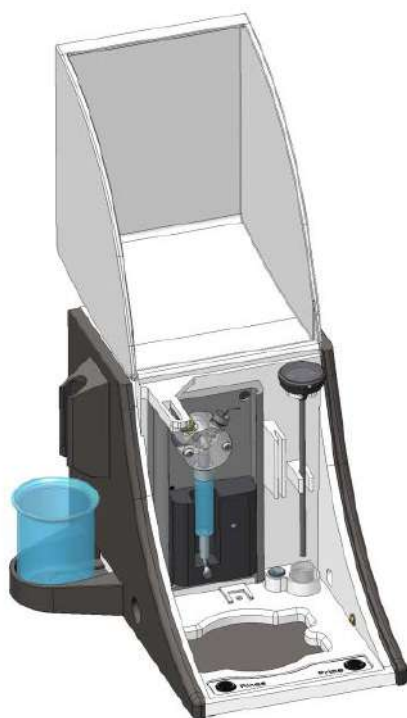

Figure 69: Injector box with carbon needle and storage tub



Figure 70: Bottle holders

## 14.2 Priming and Rinsing



**CAUTION:** The injector carrier must be in the service position for rinsing und priming. Prime and rinse must not be performed when the injector carrier is in the instrument.

The initial filling step of the injector system (priming) as well as the cleaning step of the injector system (rinsing) must take place outside of the instrument. For these procedures the injector carrier is removed from instrument and put into the service position of the injector module. For priming and rinsing steps of the injector system, a default setting for injection speed and volume dispensed is provided. If required the priming parameters can be adjusted in the Injector Control window of the software.

The prime volume depends on the tubing length. Two types of injector tubing are available: 'short' = 100 cm (39.37 in.) and 'long' = 200 cm (78.74 in.).

The minimal priming volume is 1000 µl for an injector with short tubing and 1500 µl for an injector with long tubing.



**CAUTION:** Prime volumes that are too small may result in incomplete filling of the system, and therefore may negatively affect assay performance.



**CAUTION:** Do not touch the injector needles! They can become easily bent or misaligned, which can cause injection problems or damage the instrument.

### 14.2.1 Priming

Before the injection system can be used, an initial filling step (priming) is needed to remove all air and to completely fill the system with liquid.

It is recommended to perform a rinsing step before priming.

Priming can be performed by using the software or by using the hardware button 'prime' on the injector box.

To perform the priming procedure:

1. Fill the storage bottles with the necessary reagents and insert the feeding tube(s). Make sure, that the tube(s) reaches the bottom of the bottle.
2. Remove the injector from the injector carrier port of the instrument and insert it into the service position of the injector module.
3. Put an empty container under the injector.

- Adjust parameters via the Injector/Prime window in the Dashboard or the Method Editor.

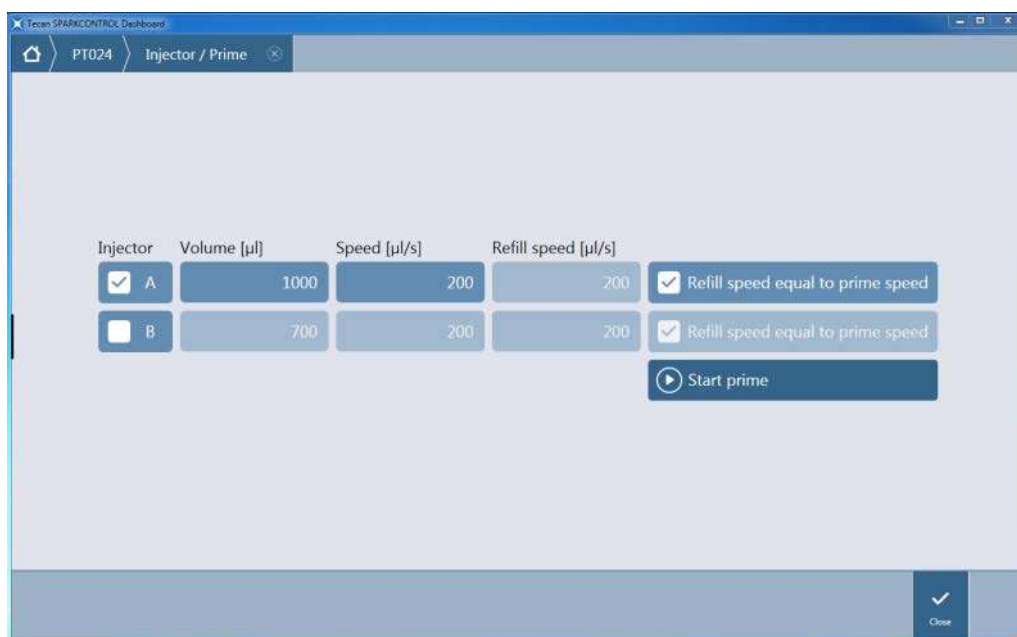

Figure 71: Priming parameters

- Visually inspect the liquid jet, the syringes for air bubbles and the tube(s) for leaks and kinks. Any bubbles should be removed after priming to ensure good injection performance.
- Select the required injector(s).
- Define the prime volume.
- Define the prime speed (values depend on selected syringe size).
- Define the refill speed (values depend on selected syringe size) or select **Refill speed equal to prime speed**.
- Start prime by clicking the **Start prime** button.
- Select **Close** to exit the Injector/Prime window.



**NOTE:** The selected settings for priming can be saved to the hardware buttons on the injector box by choosing the option Save as default. This function is only available via the Method Editor. Press the Prime button on the injector box to start the priming procedure.

After a successful priming procedure, reinsert the injector carrier into the instrument and close the lid of the injector module completely before starting a measurement. The injectors are now ready to use.

## 14.2.2 Reagent Backflush

Prior to the cleaning of the injector system, reagent backflushing allows the remaining reagent in the liquid system (injector needles, syringes, valves and tubing) to be pumped back into the storage bottles. This procedure is a cost effective solution for minimizing reagent consumption. The dead volume of the injection system is approximately 100 µl.



To perform a reagent backflush procedure:

1. Remove the injector from the carrier port and insert it into the service position of the injector box.



**WARNING:** Hold the injector carrier only by the handle provided for this purpose.

2. Insert the feeding tubing into the appropriate storage bottle.
3. Adjust parameters via the Injector/Backflush window in the Dashboard or the Method Editor.

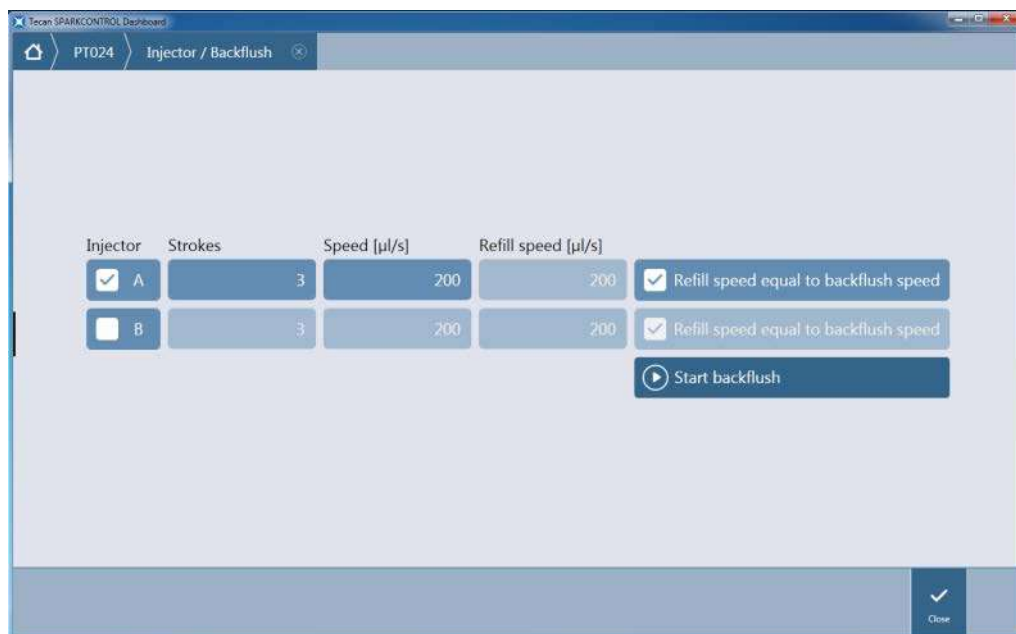

Figure 72: Backflush parameters



**CAUTION:** The injector must be in the service position for the Backflush action. Do not perform Backflush when the injector is in the instrument.

4. Select the required injector(s). Only primed injectors are available for 'backflush'.
5. Define the number of piston strokes.
6. Define the backflush speed (values depend on selected syringe size).
7. Define the refill speed (values depend on selected syringe size) or select **Refill speed equal to backflush speed**.
8. Start the reagent backflush procedure by clicking **Start backflush**.
9. Click **Close** to exit the Injector/Backflush window.

## Rinse

Before the instrument is switched off, it is recommended to perform a rinse procedure to clean the injector system. Rinsing can be started via the software or by using the hardware button 'Rinse' on the injector box.

To perform a typical rinse procedure:

1. Remove injector carrier and bring it into the 'service position'.
2. Optionally, perform a backflush procedure to feed unused reagent back into the storage bottle.

3. Fill the storage bottles with the appropriate wash reagents (distilled or deionized water, 70 % ethanol, ...) and insert feeding tubes of the injector system.
4. Put an empty container under the injector.
5. Adjust parameters via the Injector/Rinse window in the Dashboard or the Method Editor.

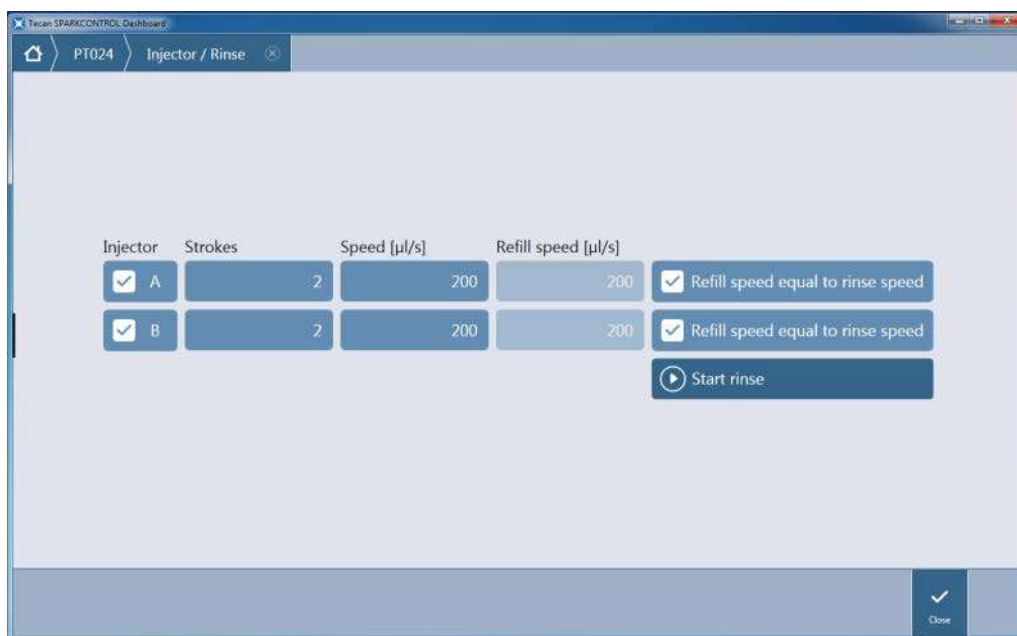

Figure 73: Rinse parameters

6. Select the required injector(s).
7. Define the number of piston strokes (1-60).
8. Define the rinse speed (depend on the syringe size).
9. Define the refill speed (depend on the syringe size) or select **Refill speed equal to rinse speed** check box.
10. Click **Start rinse** to start the rinse procedure. After the rinse procedure the syringe will remain filled, first step in the priming procedure is to empty the syringe.
11. Select **Close** to exit the Injector/Rinse window.



**NOTE:** The selected settings for rinsing can be saved to the hardware buttons on the injector box by choosing the option Save as default. This function is only available via the Method Editor. Press the Rinse button on the injector box to start the rinsing procedure.



**CAUTION:** The injector carrier must be in the service position for the Rinse action. Do not perform Rinse when the injector is in the instrument.



**CAUTION:** Be sure to run a final rinse procedure with distilled water.



**CAUTION:** Take good care of the injectors! If they are damaged, the accuracy of dispensing may be affected. This can result in damage to the instrument.

## 14.3 Injector Cleaning and Maintenance

The required maintenance may vary with your application. The following procedures are recommended for optimal performance and maximum life of the injector system.



**CAUTION:** To avoid reagent mixing and cross-contamination, rinse the whole injector system thoroughly between different applications requiring the injector(s).

### Daily Maintenance:

If not otherwise stated by the manufacturer of the kit used, the following tasks must be performed daily:

- Inspect the syringes(s) and tubing for leaks.
- Flush the whole system thoroughly with distilled or deionized water after each use and when the syringe is not in use. Failure to do so can result in crystallization of reagents. These crystals can damage the syringe seal and valve plug, which can result in leakage.



**CAUTION:** Do not allow the syringes(s) to run dry for more than a few cycles.

### Weekly/Periodical Maintenance:

The injector system (tubing, syringes, inject needles) must be cleaned weekly to remove precipitates such as salts and eliminate bacterial growth.

Follow these steps to clean the syringe/injector system with 70 % EtOH (ethanol):

1. Depending on the user's application thoroughly flush the system with buffer or distilled water before rinsing with 70 % EtOH.
2. Rinse the syringe with 70 % EtOH with syringes fully lowered for 30 minutes.
3. After the 30-minute period, cycle all the fluid from the syringe and tubing into a waste container.
4. Rinse the syringe/injector system with 70 % EtOH.
5. Rinse the syringe/injector system with distilled or deionized water. Leave the fluid pathway filled for storage.
6. Clean the end of the injector needles carefully with a cotton swab soaked in 70 % ethanol or isopropanol.



**WARNING:** Risk of fire and explosion!

Ethanol is flammable and when improperly handled can lead to explosions. Proper laboratory safety precautions must be observed.

### 14.3.1 Syringe Replacement



**CAUTION:** Syringes must only be replaced by a service technician, otherwise the performance of the instrument cannot be guaranteed.

## 14.4 Injector: Reagent Compatibility

The injector system consists of the following materials:

- PTFE, TFE, FEP: Tubing, valve plug, seal
- PEEK: Needle head, coupler tubing/injector
- KelF: Valve body
- Parylene coating: Injector needles

Please refer to the following list for reagent compatibility. Rating 'A' indicates a good compatibility with the injector system. Chemicals with the rating 'D' must not be used with the injector system. They will severely damage the injector system.

'A' Rated Chemicals	'D' Rated Chemicals
Acetic Acid < 60%	Acetonitrile
Dimethyl Formamide	Butyl Amine
Ethanol	Chloroform
Methanol (Methyl Alcohol)	Carbon Tetrachloride (dry)
Water, Deionized	Diethyl Ether
Water, Distilled	Ethanolamine
Water, Fresh	Ethylene Diamine
Potassium Hydroxide (Caustic Potash)	Furfural
Potassium Hypochlorite (aqueous)	Hexane
Sodium Hydroxide (< 60%, aqueous)	Hydrofluoric Acid
Sodium Hypochlorite	Monoethanolamine
	Sulfuric Acid (diluted or concentrated)
	Tetrahydrofuran



**CAUTION:** Use only 'A' rated reagents with the injector system. 'D' rated reagents must not be used with the injector system.

The information listed in this table has been created by Tecan Austria according to available material compatibility information and provides only a general guideline for the selection of compatible reagents.



**WARNING:** Variations in chemical behavior during handling due to factors such as temperature, pressure and concentration can cause equipment to fail, even though it passed an initial test. Serious injury may result. Use suitable guards and/or personal protection when handling chemicals.

## 14.5 Performing Measurements with Injectors

The injectors can be used alone or in combination with the following detection modes: Fluorescence Intensity top and bottom, Time Resolved Fluorescence, Fluorescence Polarization, Absorbance, Luminescence as well as Multicolor Luminescence. However, as the measurement position is not the same as the injection position, a short time delay (approx. < 0.5 s) between injection and reading occurs.

### 14.5.1 Injector Strip

This strip is used to perform injections.

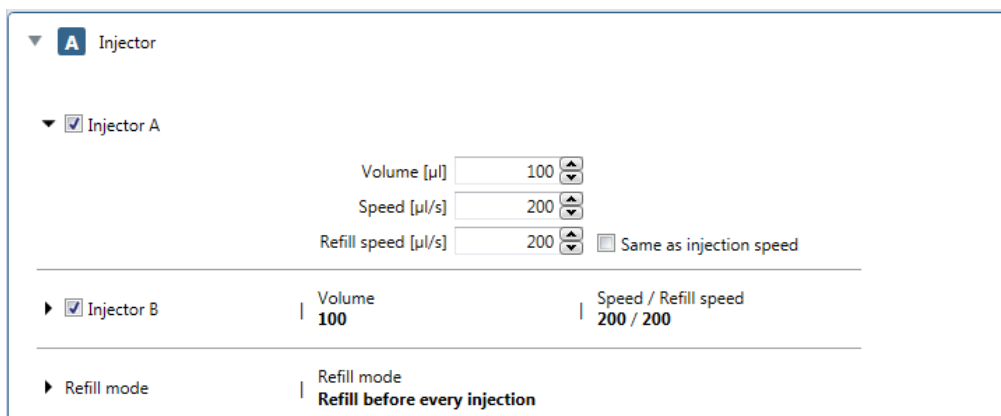

Figure 74: Injector strip

The **Injector** strip includes the following elements:

<b>Injector A Injector B</b>	Select injector A, B or both. The selection depends on the instrument configuration.
<b>Volume</b>	Define the volume to inject into a single well.
<b>Speed</b>	Define the speed of liquid flow during the injection.
<b>Refill speed</b>	Define the speed for liquid refill during the method run. <b>Same as injection speed:</b> Select the check box if the refill speed will be the same as the injection speed.
<b>Refill mode</b>	Select one of the following options: <b>Standard:</b> Injection occurs as long as the syringe contains enough liquid. As soon as the liquid in the syringe is used up, the syringe is refilled with the defined refill volume. <b>Refill before every injection:</b> Refilling of the syringe occurs before each injection step.

### 14.5.2 Injector Strip in Measurement Flow

Injection can be performed plate-wise or well-wise. The plate-wise injection means that the liquid is first injected into all selected wells of the plate, and the whole plate is measured thereafter.

For the well-wise injection, the injection strip must be inserted below a Well strip. In that case, the liquid is injected into the first well, and then this well is measured as defined, before the liquid is injected into the second well and so on.

### 14.5.3 Z-Drive Injector Port

The injector port is equipped with a Z-drive to optimize injection performance for every plate format and height. The Z-optimization is available for measurements in absorbance, luminescence and fluorescence mode and adjusted automatically by the software.



**CAUTION:** Make sure that the selected plate definition file corresponds to the actual plate being used.

### 14.5.4 Optimizing Measurements with Injection

The measurements with an injection step might be optimized by waiting and/or shaking after the injection step in order to homogenize the liquid mixture in the well before starting the next workflow.

For the corresponding strips (Wait and Shake) please refer to chapter 8.6.3 Action.

## 14.6 Heater and Magnetic Stirrer

The injector module can additionally be equipped with a heater and magnetic stirrer option. The heater is designed to keep the injection solution at the desired temperature. The stirring function keeps the injection solution in motion in order to avoid the accumulation of precipitates or debris on the bottom of the solution container. Concurrent to the heating and stirring functions, the injection solution is also protected from light during the entire experiment by the injector cover. The heater and stirrer functions are independently regulated with control knobs positioned on the module itself without the use of the SparkControl software.



Figure 75: Heater and magnetic stirrer module

The heater and magnetic stirrer option is available for both the one-syringe and the two syringe injector option. The basic heater and stirrer module consists of control knobs for temperature and stirring speed regulation. For the two syringe injector option, the basic heater and magnetic stirrer module is expanded by an additional module. The temperature and stirring speed of the expansion module is simultaneously regulated by the basic module.

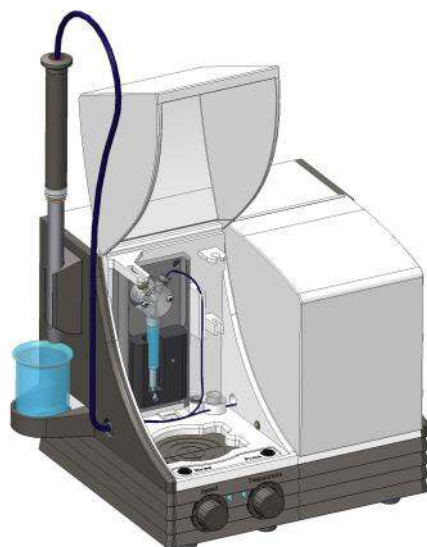

Figure 76: Injector module with two syringes and heater and magnetic stirrer option

### 14.6.1 Installing the Heater/Stirrer

To install the Heater & Stirrer module it is necessary to remove the bottom plate(s) of the injector module (see figure below). The appropriate tool to loosen the screws is delivered with the instrument. When finished, simply place the injector on top of the Heater & Stirrer module. Plug-in the power cable of the Heater & Stirrer and the module is ready to use.

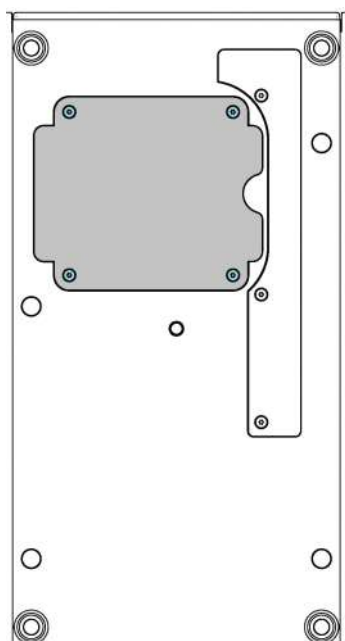

Figure 77: Bottom of the injector box.

## 14.6.2 Temperature Regulation

Temperature regulation is possible between 20 °C and 42 °C. If the temperature regulation is switched on, the status lamp is lit.

- A constant green light indicates that the target temperature is achieved.
- A constant yellow light indicates that the target temperature is higher than the actual temperature.
- A yellow blinking light indicates that the target temperature is lower than the actual temperature.
- A red or red blinking light indicates that an error occurred. (Contact your local Tecan service representative).



**NOTE:** The selected temperature equates the temperature of the surface of the heating plate. The temperature of the injection solution in the container has to be controlled explicitly by the user.



**CAUTION:** If heating is activated be aware that the basic as well as the expansion module are equally tempered!

## 14.6.3 Setting the Stirring Speed

The stirring speed can be set from 50 and 1000 rpm (revolutions per minute). When stirring is switched on, the status lamp is lit.

- A constant green light indicates that the motor is running.
- A red or red blinking light indicates that an error occurred. (Contact your local Tecan service representative).

## 14.6.4 Laboratory Flask and Magnetic Stir Bar

The heating plate is designed to accommodate a laboratory flask of up to 100 ml volume. The standard set for each heater and magnetic stirrer module consists of one 100 ml laboratory flask and an appropriate magnetic stir bar.

# 14.7 Injector Specifications



**NOTE:** All specifications are subject to change without prior notification.

## 14.7.1 Technical Specifications for the Injector

Parameters	Characteristics
Plate types	1- to 384-well plates
Injector syringe volumes	500 µl, 1000 µl



## 14.7.2 Performance Specifications for the Injector

Inject Volume	Accuracy	Precision
10 µl	≤ 5 %	≤ 5 %
100 µl	≤ 1 %	≤ 1 %
450 µl	≤ 0.5 %	≤ 0.5 %

## 14.7.3 Specifications for the Heater / Stirrer

Parameters	Characteristics
Power supply	24 V, max. 60 Watt, external plug-in
Temperature regulation	20-42 °C
Stirring speed regulation	50-1000 rpm

# 14.8 Quality Control of the Injector Module

## 14.8.1 Periodic Quality Control Tests

Depending on usage and application, we recommend a periodic evaluation of the instrument on Tecan site.

The tests described in the following chapters do not replace a full evaluation by the manufacturer or authorized dealers. But the tests may be performed periodically by the user to check significant aspects of the instrument performance.

The results are strongly influenced by errors in pipetting and the setting of the parameters in the instrument. Therefore, please follow the instructions carefully. The user should determine the appropriate intervals for this testing based on how frequently the instrument is operated.



**CAUTION:** Before starting measurements, make sure that the microplate is inserted correctly; well A1 has to be on the upper left side.



**WARNING:** The following instructions explain how to perform the Quality Control to check the specifications of the instrument. If the results of these control tests do not conform to the specifications of the instrument given in this manual, please contact your local service center for further advice.

## 14.8.2 Injector Accuracy

Accuracy is the ability of a system to give responses close to a true value. The accuracy is calculated as percentage deviation from the true value.

### Material:

- Distilled water
- Greiner 96-well plate, flat bottom, transparent
- Scales with accuracy specification of 1 mg

**Procedure:**

Prime the injector with distilled water. Weigh the empty plate and note. Inject 20 µl into 20 wells of a Greiner 96-well plate (flat bottom, transparent) plate and immediately weigh the plate again (take care of evaporation effects). Perform procedure at room temperature (25 °C).

**Injection Parameters:**

Injector	Select Injector A or B
Speed	200 µl/s
Refill speed	Same as injection speed
Refill mode	Standard
Refill volume	Default
Plate definition file	GRE96ft
Part of plate	D2-E10

**Evaluation:**

The weight of 400 µl distilled water (20 x 20 µl) at 25 °C is 398.8 mg (mass density of water is 0.997 mg/µl). Calculate the Accuracy (%) as follows:

$$\text{Accuracy (\%)} = \frac{398.8 - \text{measured}}{(398.8/100)}$$

# 15 Environmental Control

The heating, gas and humidity control of Tecan's multimode reader, SPARK, provides an optimal system for the regulation of environmental conditions during a measurement run. Stable environmental conditions are demanded by many assays to ensure optimal performance. Especially when performing live-cell experiments – a constant temperature, pH-value and humidity are required to maintain cell health and to minimize cellular response to environmental changes.

## 15.1 Heating Module

The heating module enables temperature control within a range from 4 °C above ambient temperature to 42 °C. Heating of the measurement chamber will take some time. Please check the temperature control display. If not incubated externally, the microplate should be left for equilibration before the measurement is started.



**NOTE:** To keep the temperature constant and provide uniformity across the plate, the plate must be placed in incubation position while shaking or waiting. When the heating function is used during shaking, the temperature may vary slightly.

The temperature control in the software can be activated manually or during the execution of a method.

### 15.1.1 Manual Temperature Control

The temperature control can be switched on manually via the **Temperature Control** window in the Dashboard or the Method Editor:

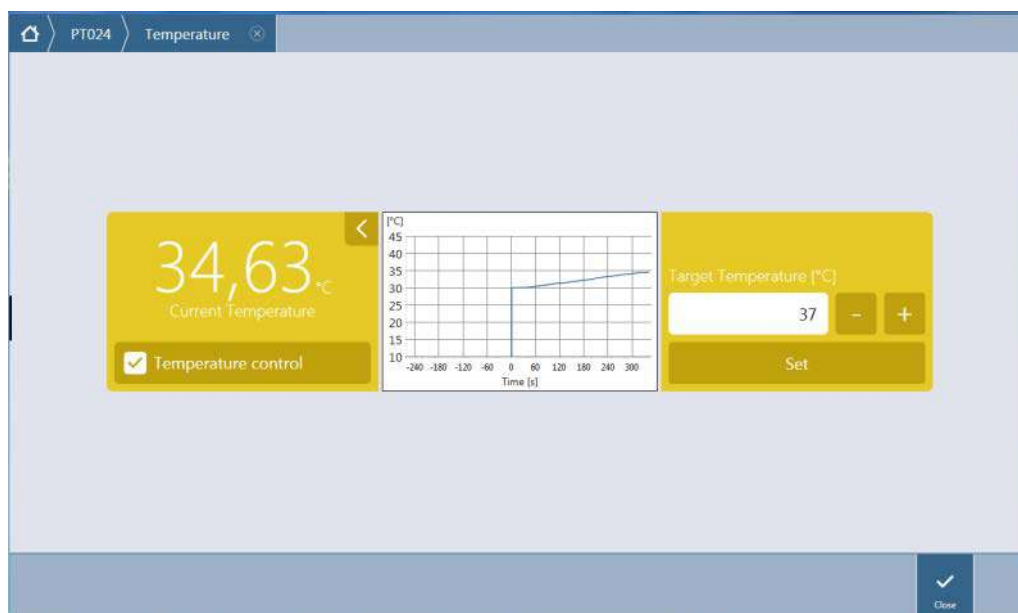

Figure 78: Temperature Control window

Select **Temperature control**. Enter the **Target Temperature** and click **Set** to start heating. View the current temperature inside the instrument by selecting the expand button at the top right of the Temperature Control tile. Clear the **Temperature** control check box to stop heating.



**CAUTION:** When defining values with decimal places always use the decimal symbol as defined in the culture settings of the PC's operating system.



**NOTE:** When starting a method with temperature control, the method settings will always overrule the manual settings if their definitions do not match.

## 15.1.2 Temperature Control via Method



**NOTE:** The heating of the instrument starts when starting the method. If **Wait for temperature** is selected, the measurement will not start until the current instrument temperature is within the specified range. For pre-heating of the instrument refer to chapter 15.1.1 Manual Temperature Control.

### Temperature Strip

This strip is used for temperature control.

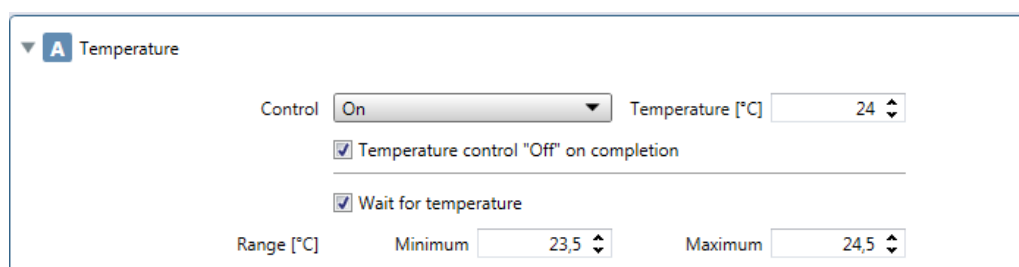

Figure 79: Temperature strip

The **Temperature** strip includes the following elements:

<b>Control</b>	Select On to enter a target temperature value.
<b>Wait for temperature</b>	Select Wait for temperature to define the Minimum and/or Maximum temperature values.
<b>Temperature control 'Off' on completion</b>	Select this option to turn off the temperature control after the measurement execution.



**CAUTION:** When defining values with decimal places always use the decimal symbol as defined in the culture settings of the PC's operating system.

## 15.2 Cooling Module (Te-Cool)

The cooling module enables temperature control in a range from 18 °C up to ambient temperature.

Preparing the instrument for cooling and the cooling of the measurement chamber itself will take some time. Please follow these instructions and check the temperature control display. If not incubated externally, the microplate should be left for equilibration before the measurement is started.

The cooling system consists of two main components: the internal cooling module and the external water cooling device. The two components form a closed circulation system.

The water cooling device is an external unit and cools the water that is used to temperate the air in the cooling module. The cooled water is pumped into the cooling module to cool the air and the heated water runs back to the cooling device to be cooled again.

The cooling module is mounted on the bottom of the SPARK multimode reader. It cools the air and blows the air into the measurement chamber of the reader. The warm air flows back to the cooling module to be cooled again.

Tecan recommends and supports the following water cooling device exclusively: **Thermoelectric Re-circulating Liquid Chiller MRC 150/300 (Laird Technologies GmbH, Germany)**. Tecan assumes no responsibility for any other product or water cooling solution. Prior to operating the Spark reader in combination with the cooling module and the water cooling device, read and follow the instructions provided by the manufacturer of the water cooling device (Laird Technologies, Operational Manual).



**WARNING:** Tecan assumes no responsibility for any other water cooling system than the one recommended in this document.



**WARNING:** Carefully read and follow the instructions given in the operating manual of the water cooling device as well.



**CAUTION:** To ensure optimal operation of the cooling module, an annual maintenance procedure must be performed by a Tecan service technician.

### 15.2.1 Connecting the Cooling module



**CAUTION:** If the liquid cooling device is used after it has been placed in storage or transported, it should be left to stand for at least 3 hours, to allow for temperature adjustment.

Before activating the cooling control option, ensure that the designated site meets the following requirements. Operate the cooling in a well-tempered and clean environment, the location must be even. Do not expose or locate the instrument near direct sunlight or heat sources. Leave sufficient distance behind the instrument for access to the rear panel.



**NOTE:** The ambient temperature sensor is located on the inside of the rear panel of the instrument and may be influenced by nearby heat sources.

The water cooling device has an air-cooled refrigeration system. The water cooling device must be positioned so that the air flow is not restricted. Supply and return flow connections must be easily accessible and all tubes must be installed without sharp bends. A minimum clearance of 0.3 meters on all vented sides is necessary for adequate ventilation.



**CAUTION:** Leave enough space between water cooling device and adjacent objects, 0.3 meters on all vented sides. Inadequate ventilation will cause a reduction in cooling capacity and compressor failure.

## 15.2.2 Cooling Circuit Connection and Filling

### Coolant

Only distilled water-propylene-glycol mixture may be used as a coolant. A propylene-glycol concentrate is obtainable from Tecan. This concentrate (0.25L concentrate) must be diluted with 0.75L distilled water prior to use to obtain 1L of a 25% working solution. Never use any other coolant or tap water to avoid instrument damages caused by pollution and corrosion!



**CAUTION:** Only use the recommended fluids with the cooling module otherwise the instrument or the water cooling device could become damaged (limescales, impermeability of tubing).



**CAUTION:** Never operate the water cooling device without cooling fluid in the reservoir!

### Connection Procedure



**CAUTION:** Use only cooling hoses with no signs of damage.

The following information details the connection procedure:

- Spark reader and water cooling device: Make sure that the main power cables are unplugged and the main power switch is in the OFF position.
- Connect the coolant OUTLET of liquid supply of the liquid cooling device to the instrument's SUPPLY port on the back of the cooling module. Use the provided tube. (See figure below and Figure 81).
- Connect the coolant INLET of liquid return of the liquid cooling device to the instrument's RETURN port on the back of the cooling module. Use the provided tube.
- Connect the Cooling module to the instrument's cooling port, use the provided CAN cable. (See figure below and Figure 83).
- Connect the condensate tube from the CONDENSATE OUTLET on the rear panel of the instrument (cooling module). Place a condensate collector at the end of the tube. A condensate collector is not delivered with the instrument. (See figure below and Figure 82).
- Open the coolant reservoir of the water cooling device by removing the cap. (See figure below).
- Fill the coolant container with about 0.25/0.45 litres of coolant.
- Close the coolant reservoir of the water cooling device by replacing the cap. (See figure below).

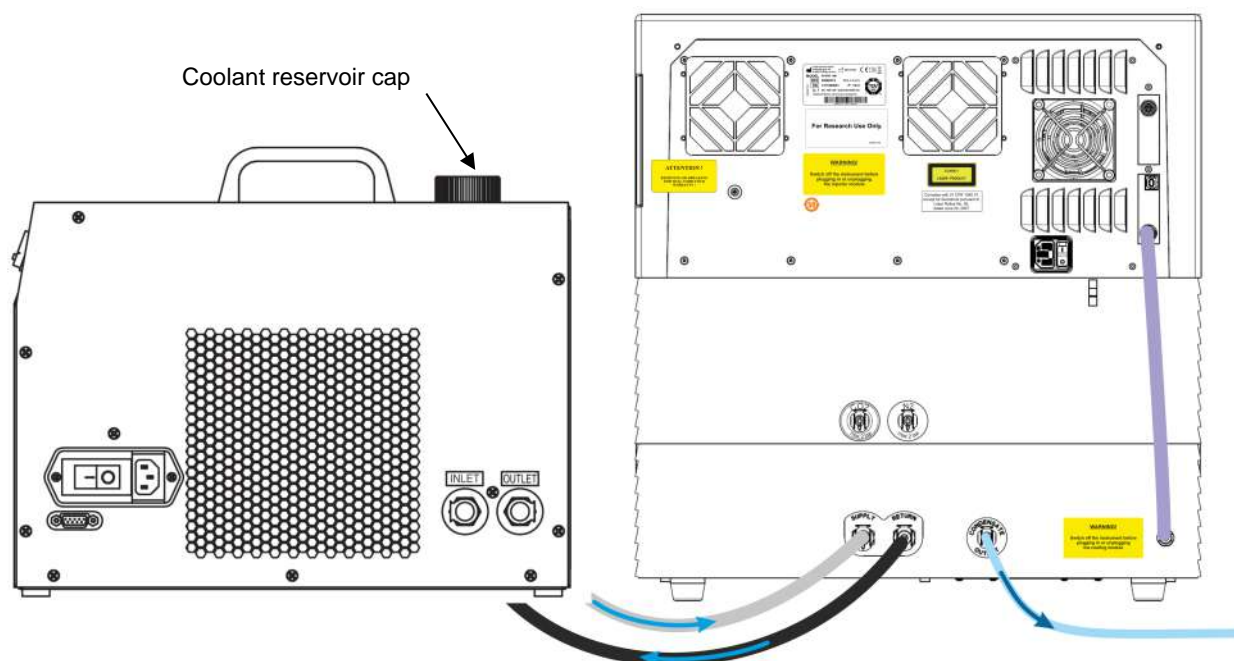
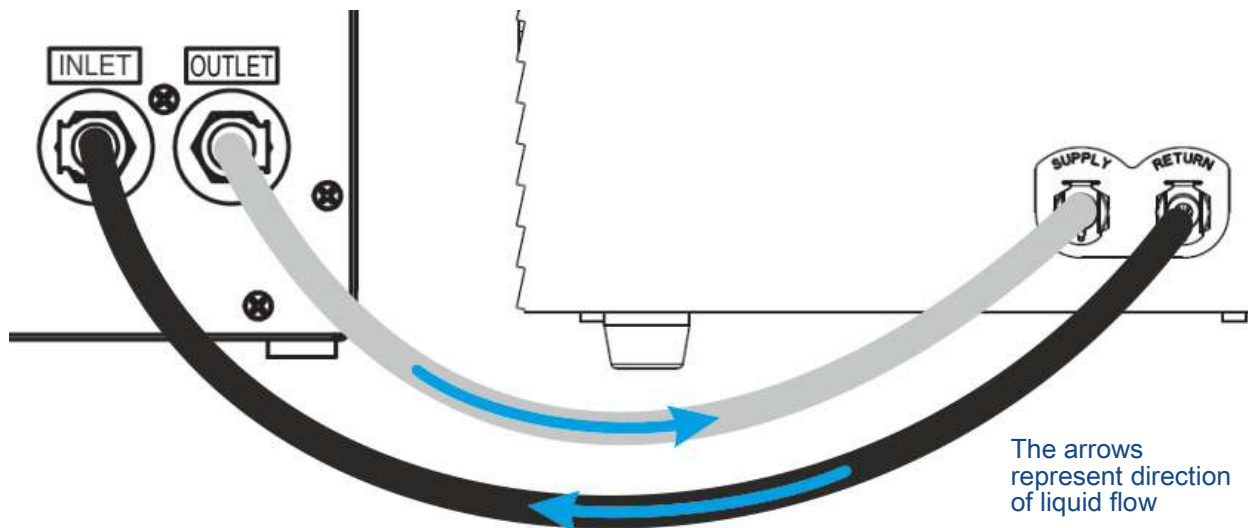

Figure 80: Spark with cooling module connected to the liquid cooling device



The arrows represent direction of liquid flow

Figure 81: Cooling module/liquid cooling device connections



To condensate collector

Figure 82: Condensate outlet

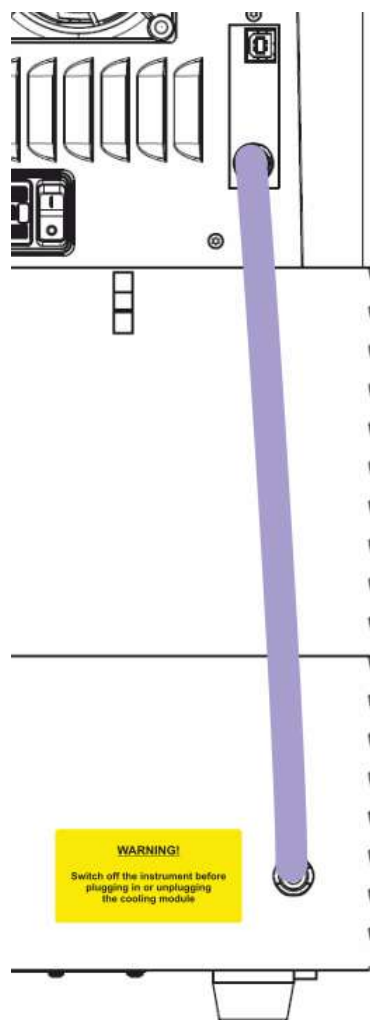

**WARNING!**  
Switch off the instrument before plugging in or unplugging the cooling module

Figure 83: CAN cable



### 15.2.3 Starting the Water Cooling Device for the First Time

1. Remove the cap of the coolant reservoir and fill the reservoir 2/3 full with fluid.
2. Connect the main power cable of the water cooling device to an appropriate AC power source.
3. Switch on the unit and let it run for about 10 minutes in order to fill and vent the cooling circuit. Continuously check the filling level during this procedure. If required add coolant.
5. Check the compliance with the operational parameters (See the Operating Manual of the water cooling device).
6. Set digital controller to 12°C (see the Operating Manual of the water cooling device).
7. Replace the cap on the coolant reservoir.
8. The unit is now ready for operation.



**NOTE:** For daily Start-up, switch on the unit about one minute prior to usage.



**CAUTION:** Place the water cooling device as close as possible to the instrument being cooled. Tubing should be straight and without bends.

### 15.2.4 Operating the Cooling module

Switch on the main power switch of the water cooling device and set target temperature to 12°C. To set temperature refer to Operating Manual, Laird Technologies, Thermoelectric Re-circulating Liquid Chiller MRC 150/300.

Wait for water equilibration before starting a measurement by using the cooling function of the SPARK Control Software. Depending on target temperature settings and ambient conditions the tempering of the measurement chamber will take 30 to 90 minutes.

Two condensation prevention stoppers are delivered with the instrument (see figure below). They fit into the slots on the left and the right side of the cooling module. They should not be installed by default. If installed the cooling module will heat up and target cooling temperature may not be achieved. They must be installed if the cooling function operates at full capacity (large difference between ambient temperature and target temperature) to prevent condensation. Otherwise an accumulation of water might be observed.

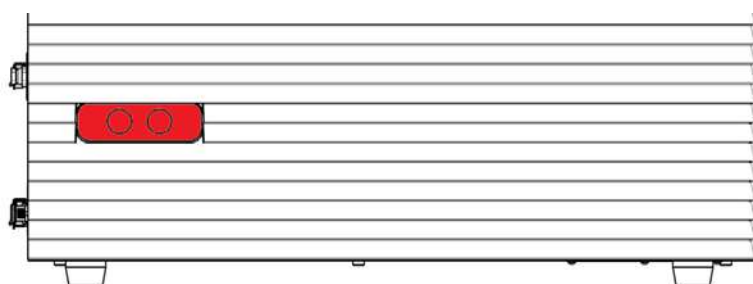

Figure 84: Condensation prevention stoppers (both sides of the instrument)



**NOTE:** The condensation prevention stoppers must only be installed by the user if a large difference between ambient temperature and target temperature is expected.

## 15.2.5 Cooling Control Software Settings



**NOTE:** Always switch on the cooling device when working with temperature control.

For the software settings please refer to 15.1 Heating Module

### Ambient Cooling Mode

The ambient cooling mode is designed to easily set the room temperature as target temperature for the instrument. It can be activated via the **Temperature Control** window in the Dashboard or the Method Editor:

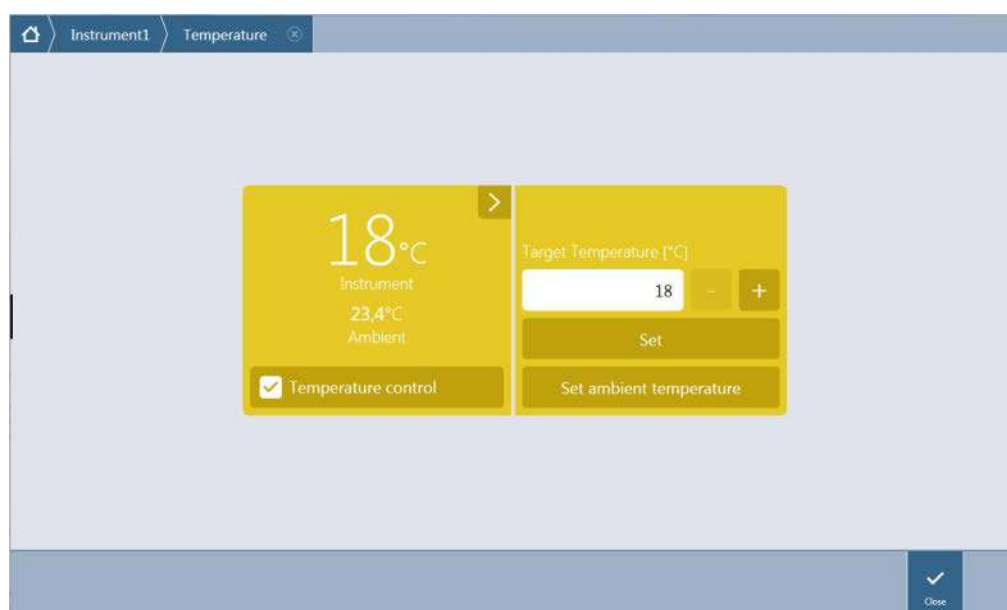

Figure 85: Temperature Control window for instruments with the cooling module

Select **Temperature control** and click **Set ambient temperature**. The current ambient temperature will be set automatically as the target temperature. View the current temperature inside the instrument by selecting the expand button at the top right of the Temperature Control tile. Clear the **Temperature control** check box to stop cooling.



**NOTE:** Always switch on the cooling device when working with temperature control.

## 15.2.6 Alarm Function/Troubleshooting

For water cooling device alarm functions and for troubleshooting refer to the Operating Manual, Thermoelectric Re-circulating Liquid Chiller MRC 150/300 (Laird Technologies GmbH).

For further technical support and services contact your local Tecan Customer Support organization.

## 15.2.7 Maintenance

For water cooling device maintenance refer to the Operating Manual, Thermoelectric Re-circulating Liquid Chiller MRC 150/300 (Laird Technologies GmbH).

For daily maintenance inspect the tubes for kinks and leaks and check that all tubes are connected properly. Check if the liquid chiller is filled up with cooling fluid.

## 15.3 Gas Control

The gas control module offers a comprehensive solution for a variety of cell-based applications for the SPARK multimode reader. Two integrated gas inlets allow the control of CO<sub>2</sub> and O<sub>2</sub> to help maintain stable culture conditions and improve cell growth. Carbon dioxide concentration is regulated by an inflow of CO<sub>2</sub> gas, whereas oxygen reduction is achieved by supplying N<sub>2</sub> gas.

The gas control module is suitable for in vitro studies of eukaryotic cell lines or extends the usage of the instrument for microplate investigations using anaerobe or facultative anaerobic bacteria.

The gas control module is available in two configurations:

CO <sub>2</sub> configuration:	CO <sub>2</sub> concentration can be regulated inside the measurement chamber
CO <sub>2</sub> and O <sub>2</sub> configuration:	CO <sub>2</sub> and/or O <sub>2</sub> concentrations can be regulated inside the measurement chamber.

### 15.3.1 Gas Safety

Adhere to the following guidelines:

- Always follow basic safety precautions when using the gas control module to reduce the risk of injury, fire, or electrical shock.
- Read and understand all information in this chapter. Failure to read, understand, and follow the instructions in this chapter may result in damage to the instrument or gas control module, injury to operating personnel or poor instrument performance.
- Observe all WARNING and CAUTION statements in this chapter. Ensure that this safety information is accessible for every employee working with the gas control module.
- Furthermore, it is assumed that instrument operators, due to their vocational experience, are familiar with the necessary safety precautions for handling gas and biohazardous substances.
- Precautions must be taken when working with potentially infectious material. Make sure to treat biohazardous material according to applicable safety standards and regulations as well as good laboratory practice guidelines.
- Wear protective glasses when using compressed gases outside of the instrument when the instrument is open.



**WARNING:** The gas control option is designed for CO<sub>2</sub> (carbon dioxide) and N<sub>2</sub> (nitrogen) supply only. The gas control option must only be used by trained personnel. Never use a flammable or cryogenic gas supply!



**WARNING:** Adequate ventilation must be provided for the room in which CO<sub>2</sub> and N<sub>2</sub> are used.



**WARNING:** Follow the security measures for working with compressed gas (transportation, storage, handling and use)!

The CO<sub>2</sub> and N<sub>2</sub> gas cylinders must be securely fastened upright to a large, stationary object at all times.

Always protect the gas cylinder from falling! A compressed gas cylinder which falls and is damaged can easily become a lethal projectile!

### 15.3.2 Gas Connection

Before activating the gas control option, ensure that the designated site meets the following requirements. Operate the gas control module in a well-ventilated, temperature and humidity controlled (air-conditioned) environment.

**Temperature:** 15 °C (59 °F) – 35 °C (86 °F)

Do not expose or locate the instrument near direct sunlight or heat sources.

Maintain a low-dust environment. Keep liquids and vapors away from the instrument.

Leave sufficient distance behind the instrument for access to the rear panel. Make sure that all gas tubes are accessible and in no way obstructed.



**WARNING:** Follow appropriate gas handling precautions and safety regulations when setting up the CO<sub>2</sub> and/or N<sub>2</sub> supply. Read all label information and material safety data sheets (MSDS) from the manufacturer or supplier.



**WARNING:** Always use a regulator approved for the specific gas with high- and low-pressure gauges.

The following information details the gas connection procedure:

Connect the pressure regulator's outlet of the CO<sub>2</sub> gas cylinder or laboratory gas handling system to the instrument's inlet port ('CO<sub>2</sub>') on the back. Use the provided tube with quick connector and attach the tube to the regulator of the cylinder with a plastic clamp, as depicted in the figure below.

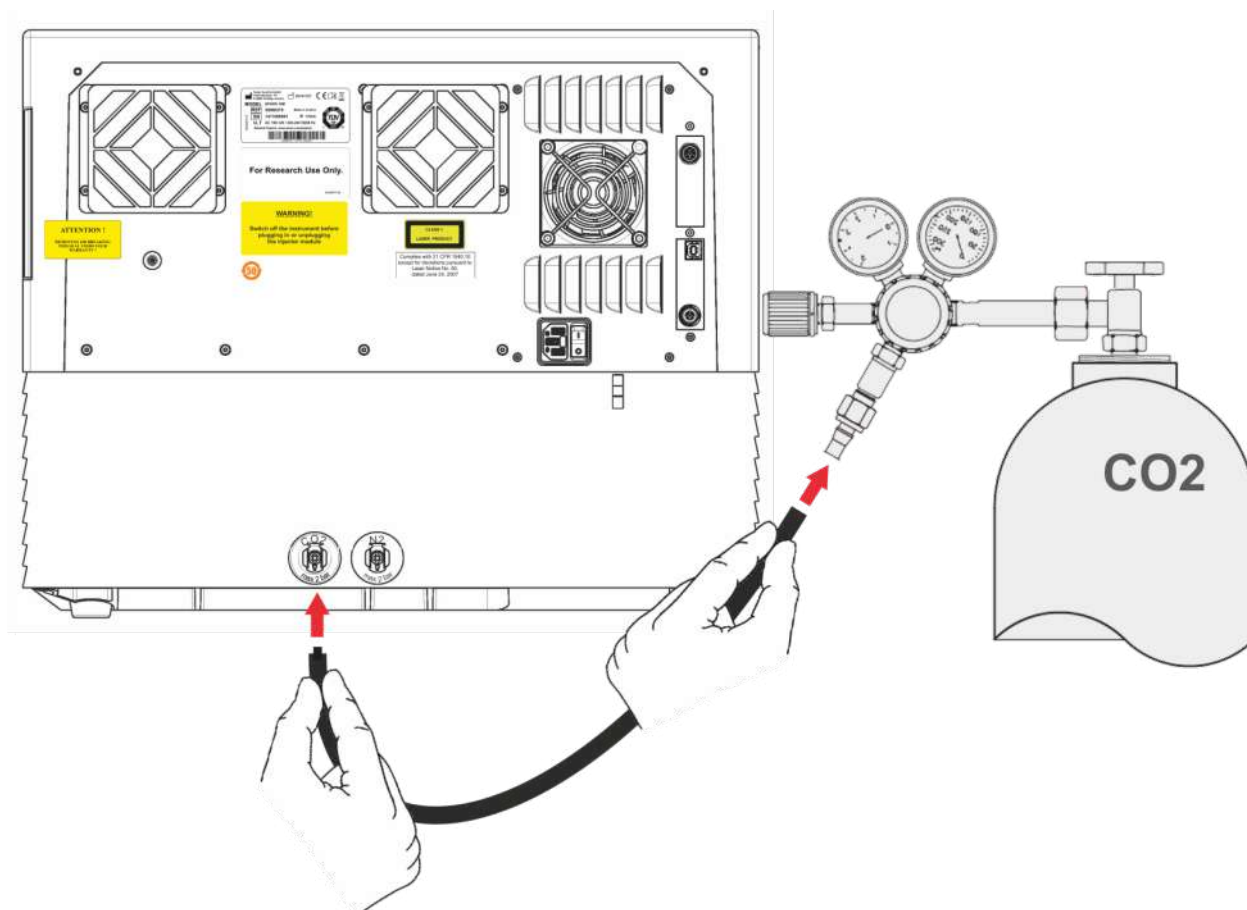

Start the SparkControl software and enter the sea level height of your location (refer to chapter 8.12.2 Instrument).



**NOTE:** Before starting work with the gas module, the sea level height of your location must be entered via the SparkControl software.

If the GCM is configured for 'CO<sub>2</sub> and O<sub>2</sub>', nitrogen gas can be used to regulate the amount of oxygen, in addition to CO<sub>2</sub> regulation. Connect the pressure regulator's outlet of the N<sub>2</sub> gas cylinder or central gas supply to the instrument's inlet port ('N<sub>2</sub>') on the back. Use the provided tube with quick connector and attach the tube to the regulator of the cylinder with a plastic clamp, as depicted in the figure below.

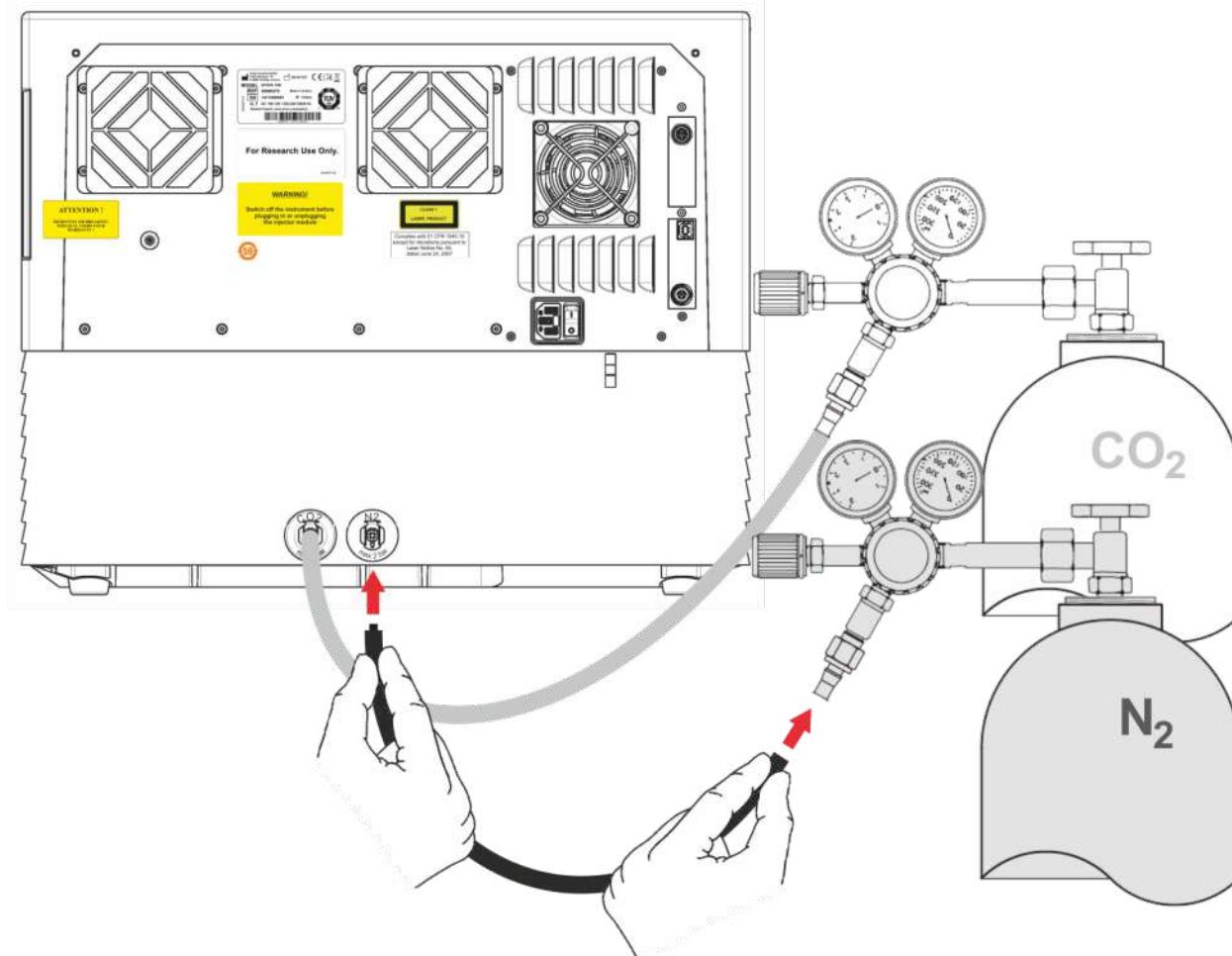

### 15.3.3 CO<sub>2</sub> and N<sub>2</sub> Gas Cylinders (Not Supplied)

To control the gas concentration, gas cylinder(s) or a laboratory gas handling system with pressure reduction valves are required.

Gases: Carbon Dioxide (CO<sub>2</sub>) to regulate CO<sub>2</sub> concentration; Nitrogen (N<sub>2</sub>) for the reduction of O<sub>2</sub> concentration (e.g. 50 Liter cylinder).

The pressure reduction valve must have two gauges – one for the pressure in the bottle (high pressure gauge) and one for the reduced pressure of max 2 bar (max 29 psi; low pressure gauge). Take care that the display for regulating the pressure has a range of 5 bar (72.5 psi) or maximum 15 bar (217.5 psi) to allow regulation from 1 – 2 bar. Make sure that the pressure reduction valve is designed for use with biological applications (ask manufacturer).

The connection from gas cylinder to pressure reduction valve is different for each country. Check with a gas cylinder company in your country for the proper connection! Check that the connection piece of pressure reduction valve matches the inner diameter of the gas tube to the instrument (The inner diameter of this tube is approx. 6 mm). The tube on the connector to the pressure reduction valve must be secured with a plastic clip; a pair of pliers will be necessary to perform this task.

Make sure that there are no bends or kinks in the tubing.

If necessary, convert bar into psi:  $\text{bar} \times 14.5 = \text{psi}$  (pounds per square inch), e.g. 2 bar = 29.0 psi.

To protect the gas cylinder from falling, a cylinder stand or table mount (with a securing chain or strap), or gas cylinder cradle can be bought from a gas cylinder company or ordered from a laboratory catalog.



**WARNING:** Before opening the main valve, ensure that the regulator and the shut-off valves are closed.



**WARNING:** Make sure that the gas (CO<sub>2</sub> and N<sub>2</sub>) to the instrument does not exceed a maximum pressure of 2 bar.



**WARNING:** Keep the injector port closed during gas supply. Insert the injector dummy if the injector is not in use.



**WARNING:** Before running a method with gas supply check gas tubes and connectors for leaks and ensure that tubes and connectors are fixed properly.

### 15.3.4 Gas Control Software Settings

The gas control can be activated manually or within a method execution.



**NOTE:** When starting a method with gas control, the method settings will always overrule the manual settings, if their definitions do not match.



**NOTE:** Before starting work with the gas module, the sea level height of your location must be entered via the Instrument settings (refer to chapter 8.12.2 Instrument).

### 15.3.5 Manual Gas Control

The gas control can be switched on manually via the **Gas** Control window in the Dashboard or the Method Editor.

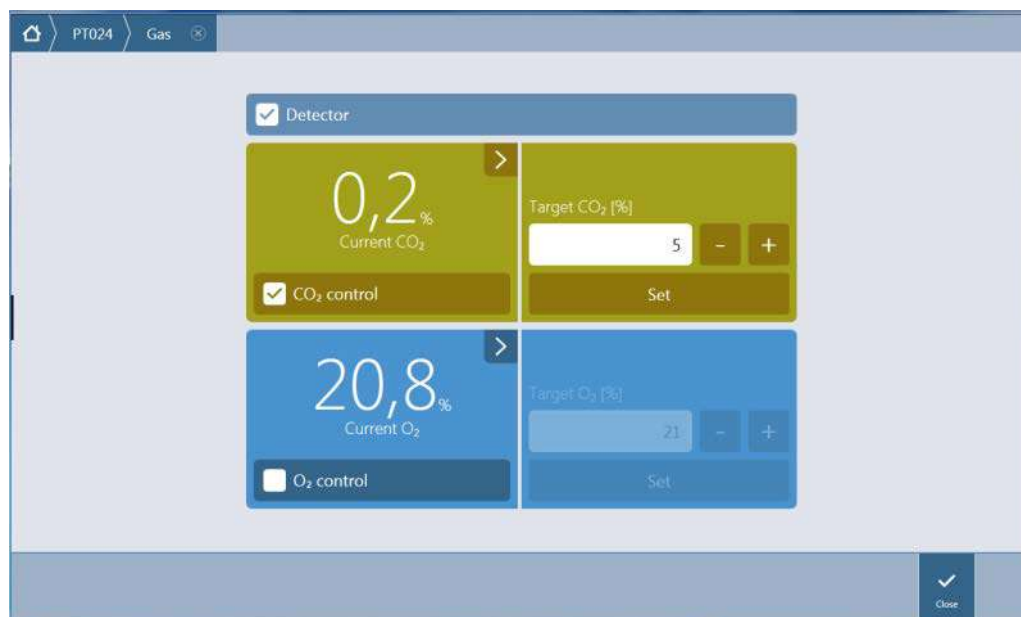

Figure 86: Gas Control window

Select **Detector** to switch on the gas detector(s). Select CO<sub>2</sub> control or/and O<sub>2</sub> control. Enter the target gas concentration and click **Set** to start gas regulation. View the current gas concentration inside the instrument by selecting the expand button top right in the control tile(s). Clear the gas control check box(es) to stop gas regulation. Clear the **Detector** check box to switch off the gas detectors.



**CAUTION:** When defining values with decimal places always use the decimal symbol as defined in the culture settings of the PC's operating system.



**NOTE:** Switching on the gas detector(s) might take a few minutes.

### 15.3.6 Gas Control via Method



**NOTE:** Gas regulation starts when the method starts. If **Wait for gas** is selected, the measurement will not start until the current gas concentration is within the specified range. For information about adjusting the gas settings prior to performing measurements, refer to chapter 15.3.5 Manual Gas Control.



**NOTE:** Turning on the gas detector(s) might take a few minutes. We recommend turning on the detector(s) before starting a measurement with gas control.



## Gas Strip

This strip is used for gas control.

Figure 87: Gas strip

The **Gas** strip includes the following elements:

<b>Control</b>	Select <b>On</b> to start the gas control
<b>Gas module</b>	Select one of the following options: <b>CO<sub>2</sub></b> , <b>O<sub>2</sub></b> , <b>CO<sub>2</sub> and O<sub>2</sub></b> and <b>O<sub>2</sub>, Monitoring</b> . Use the last one to monitor the CO <sub>2</sub> and/or O <sub>2</sub> concentration without turning on the internal gas regulation.
<b>Wait for gas</b>	Select it this option to define the <b>Minimum</b> and/or <b>Maximum</b> gas concentration values.
<b>Gas control 'Off' on completion</b>	Select this option to turn off the gas control after the measurement execution.
<b>Gas detector 'Off' on completion</b>	Select this option to turn off the gas detector after the measurement execution.



**CAUTION:** When defining values with decimal places always use the decimal symbol as defined in the culture settings of the PC's operating system.



**WARNING:** Ensure that a sufficient supply of CO<sub>2</sub> or N<sub>2</sub> is provided during incubation. Running out of gas or failure of gas supply may negatively affect or harm your cell application.



**WARNING:** Make sure to apply a suitable gas-permeable adhesive foil, tape, or cover to the microplate. Sealing the plate facilitates the gas exchange (ventilation) of cultures while simultaneously acting as a barrier to reduce evaporation during gas supply.



**NOTE:** Always include appropriate positive and/or negative controls in your assay to reflect effects on cell viability during incubation.



**WARNING:** Treat bio-hazardous material according to applicable safety standards and regulations.

### 15.3.7 Acoustic Alarm

If the target concentration is not reached within 20 minutes after the initial activation of a gas mode or when it deviates for more than 10 minutes during operation, i.e. with a deviation ( $> \pm 20\%$ ), an acoustic alarm will sound. This will help you to recognize, for example, when the gas supply has run out (tank is empty). A message appears specifying which gas is affected and to check the corresponding gas cylinder. Click **OK** to stop the acoustic alarm and continue the method.



Figure 88: Stopping the gas alarm

If power is lost, the gas valves will close automatically.

## 15.4 Humidity Control

Evaporation is most pronounced when carrying out long-term studies (3 days or more). Especially when performing live-cell experiments over long periods of time significant evaporation effects may occur, affecting the outer wells of the microplate and the corner wells in particular. When the water evaporates the concentrations of substances in the medium will increase, which can influence cell growth and performance, causing heterogeneous or biased results.

The humidity cassette passively stabilizes the humidity and reduces evaporation for lengthy incubations. The humidity cassette is combinable with all plate formats from 1 to 384 wells complying with the SBS standard. It also allows for simultaneous incubation, signal detection in all measurement modes. Gas exchange (ventilation), signal detection as well as injection steps are supported in combination with the lid lifting option. Shaking in combination with the Humidity cassette is restricted to orbital and double orbital mode.



**NOTE:** The humidity cassette is always combined with the lid lifting option.

### 15.4.1 Humidity Cassette

The humidity cassette consists of water reservoirs and a lid with magnetic foil to facilitate lid lifting. The lid is closed to prevent evaporation. To allow gas exchange, the lid lifting option (ventilation) must first be selected in the software.



Figure 89: Humidity cassette

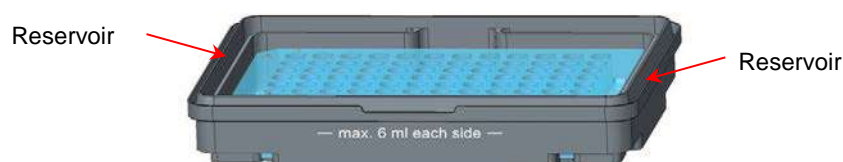

Figure 90: Basic part of the humidity cassette which holds the microplate and contains the water reservoirs

Two different cassette types, a large one and a small one, are offered to shelter different types of microplates.

**Small cassette:** Usable for 96- and 384-well plates without plate lid. The maximum height is 16 mm. By using the lid lifting option in the software, all detection modes can be combined with the low humidity cassette. Maximum filling level of 4 ml in each reservoir.

**Large cassette:** Usable for 6- to 384-well plates with or without plate lid with a maximum height of 23 mm (including lid). By using the lid lifting option in the software, all detection modes except luminescence can be combined with the high humidity cassette. Maximum filling level of 6 ml in each reservoir.



**WARNING:** Select the correct humidity cassette type (small or large) in the software to avoid instrument damages.

## 15.4.2 Handling Procedure

1. Fill each reservoir with 3-4 ml distilled water in case of the small cassette and with 6 ml water in case of the large cassette type by using a pipette.
2. Insert the microplate (with or without lid) containing samples to be investigated into the basic part of the humidity cassette. Check that the orientation is correct, the cassette is labeled accordingly.
3. Place the lid on the cassette to properly close the humidity cassette, match A1 position of the microplate with the A1 position of the cassette lid.
4. Put the humidity cassette on the plate carrier. Take care of correct orientation the position of well A1 has to be on the upper left side.



Figure 91: Microplate on the plate carrier with the A1 well in the upper left-hand corner

5. Start method.



**CAUTION:** Before starting measurements by using the humidity cassette, make sure that the microplate position and the cassette position A1 is inserted correctly. The position of well A1 has to be on the upper left side.



**WARNING:** Do not fill more water into the reservoirs than recommended to avoid spill over.



**WARNING:** Before the humidity cassette is placed on the plate transport ensure that the cassette lid closes properly.

6. After the end of the run and the plate carrier has been moved out, the humidity cassette containing the sample microplate can be easily removed from the plate carrier. Remove the lid of the cassette and put the lower part of the cassette containing the microplate on the unloading tool to easily remove the plate from the cassette.

The humidity cassette can be cleaned by using 70 % ethanol or sterilized at maximum 125°C.

The unloading tool is located in the original packaging of the humidity cassette underneath the lower part of the humidity cassette. It has been cut from the material of the packaging, but not removed. Remove the foam piece by pushing it out.



Figure 92: Unloading tool (Part of packaging)

### 15.4.3 Software Settings

The humidity cassette can be selected within the Plate strip (refer to chapter 8.6.1 Plate).



**NOTE:** A humidity cassette is used in combination with the lid lifter. Please make sure to attach a magnetic pad to the cassette lid before use.



**NOTE:** The option Removable Lid cannot be used with the Humidity cassette. If a plate cover is used, select the option Lid in the software.

#### Ventilation

The ventilation settings, i.e. the duration and interval time, can be defined within the **Shake** and **Wait** strips.

#### Shaking

Shaking in combination with the humidity cassette is restricted to orbital and double orbital mode to avoid liquid spilling.

## 15.5 Environmental Control Specifications



**NOTE:** All specifications are subject to change without prior notification.

### 15.5.1 Heating

Parameters	Characteristics
Heating range	+4 °C above ambient up to +42 °C
Heating range with active gas control	+5 °C above ambient up to +42 °C
Heating uniformity	< 0.5 °C between 30 °C and 37°C at incubation position
Environmental operating conditions	+15 °C to +35 °C

### 15.5.2 Cooling

Parameters	Characteristics
Cooling range	+18 °C up to 42 °C
Cooling uniformity over a 96-well plate	< 1.0°C at a plate temperature between 18 °C and 37 °C
Environmental operating conditions	+18 °C to +30 °C

### 15.5.3 Gas Control

Parameters	Characteristics
CO <sub>2</sub> concentration range	0.04 % to 10 % volume
CO <sub>2</sub> concentration accuracy	< 1 %
O <sub>2</sub> concentration range	0.1 % to 21 % volume (imprecise regulation below 0.5 % and below 0.8 % with active cooling)
O <sub>2</sub> concentration accuracy	< 0.5 %



**NOTE:** Sensitivity of the CO<sub>2</sub> sensor below 0.1 % is imprecise.

### 15.5.4 Humidity Control

Parameters	Characteristics
96-well plate with lid, 4 days incubation at +37 °C with 5 % CO <sub>2</sub>	Evaporation < 10 % (excluding the outside wells; first and last column, first and last row)
Operating condition	+18 °C to +42 °C

## 16 NanoQuant App

The NanoQuant Plate is intended to quantify nucleic acids and proteins in a small volume of 2 µl by using absorbance as detection mode. Up to 16 samples can be measured at a time.

Tecan provides two ready-to-use apps for the routine analysis of nucleic acids: the NanoQuant Quantitation App, which is used for the quantitation of nucleic acids at 260 nm and to enable quick access to the information about the concentration and purity of applied samples. The Labeling Efficiency App additionally provides information on the concentration of the marker(s) used in the labeling procedure.



Figure 93: The NanoQuant Plate

### 16.1 Nucleic Acid Quantitation App

Measuring the inherent absorbance of nucleic acid samples at 260 nm forms the basis for this app. The concentration levels of the samples are calculated from the values obtained. To determine the purity of the nucleic acid, additional measurements at 280 nm and 230 nm are performed followed by an absorbance scan in the range of 200 to 1000 nm. The measurement at 280 nm is performed to check for the presence of proteins in the sample. The corresponding absorbance value is used for the calculation of the index of purity, which is a ratio between the measured values at 260 and 280 nm. The measurement at 230 nm is performed to check the sample for contamination by carbohydrates, salts or organic solvents. In this case, a ratio of the measured signals at 260 and 230 nm is calculated and used as an indicator for the purity of the sample.



**NOTE:** Pure DNA samples show a 260/280 ratio between 1.8 and 1.9, while pure RNA samples have a ratio of about 2.0. Lower ratio values may indicate the presence of proteins or other contaminants. If this is the case, an additional purification step is recommended.



**NOTE:** Pure nucleic acids show a 260/230 ratio in the range of 2.0 – 2.2. If this ratio is appreciably lower than expected, it may indicate the presence of, for example, salts or organic solvents. If this is the case, an additional purification step is recommended.

### 16.1.1 Applying Samples

The fastest way to apply samples onto the NanoQuant Plate is by using an 8 channel pipette. The precise and consistent application of the samples is ensured by the use of optimal tips for the pipette.

If help with the application of the samples is needed, the pipetting aid is recommended. The pipetting aid has to be placed onto the quartz lenses with the indentation downward. After applying the samples onto the quartz lenses, the pipetting aid has to be removed carefully without touching the sample drops. Close the lid carefully and put the plate onto the plate carrier.

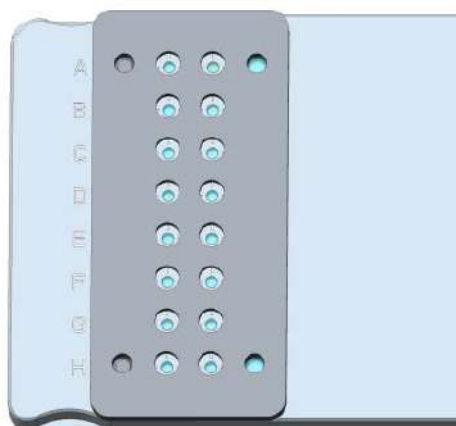

Figure 94: The NanoQuant pipetting aid

Optionally, a single pipette can be used for the application of samples to the NanoQuant Plate. To increase precision and to avoid cross contamination with other samples, it is highly recommended to use a new tip for every sample. Work in a timely manner – otherwise samples may quickly evaporate leading to false results.

### 16.1.2 Starting the Nucleic Acid Quantitation App

The Nucleic Acid Quantitation application can be started via:

- The Dashboard by selecting the corresponding application tile or
- The Method Editor by selecting the application from a drop-down list placed top right (-> Select app).

#### Blanking

Before quantifying the nucleic acids, a blanking measurement must be performed.

Perform blanking as follows:

1. Start the Nucleic Acid Quantitation application tile.
2. Select the wells to be used for blanking (by default all wells are selected).
3. Select Sample in the action bar to select the sample types if another sample other than ds DNA is measured (by default “ds DNA” is selected, see figure below)

The following selections are possible:

- ds DNA
- ss DNA
- RNA
- or select **Edit Sample** in the action bar



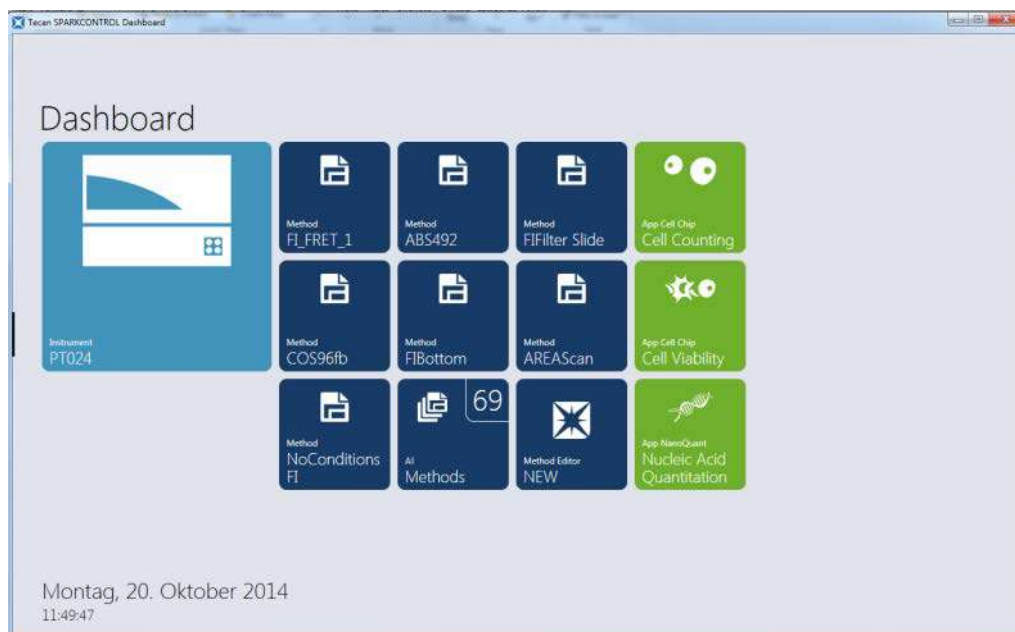

Figure 95: Start the app via Dashboard

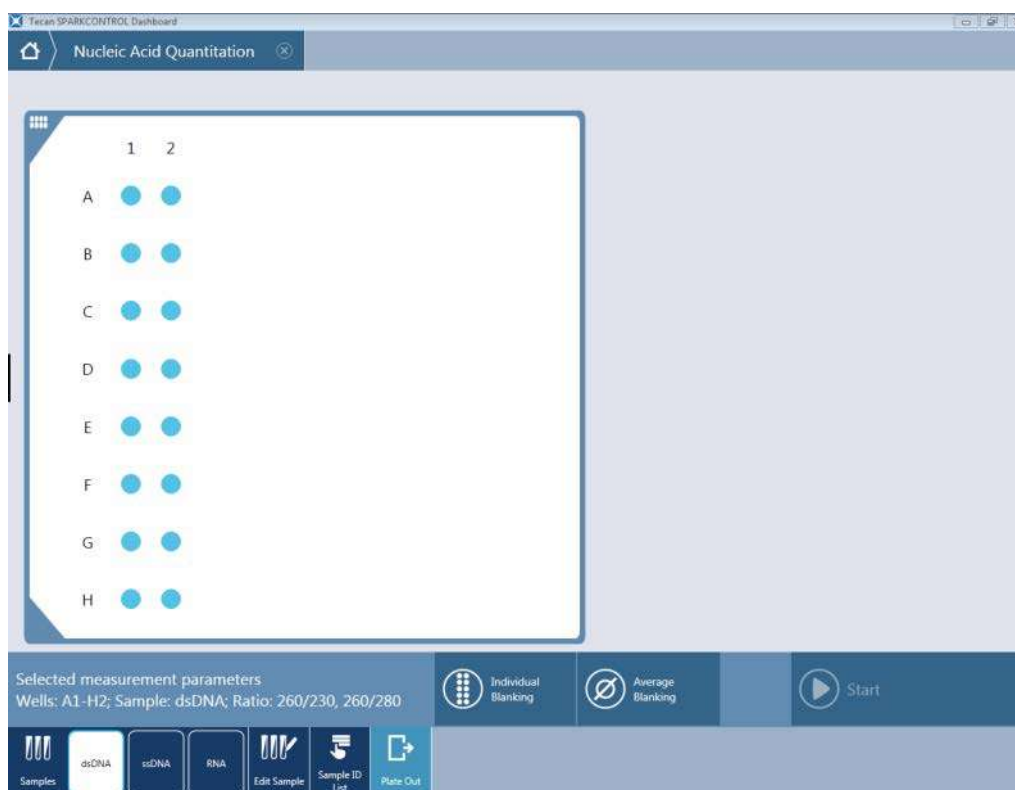

Figure 96: Start Blanking window

1. Load the blanks onto the selected positions for blanking and close the lid of the NanoQuant Plate carefully.
2. Select **Individual Blanking** to start the individual blanking procedure or **Average Blanking** to start the average blanking procedure.



**NOTE:** Individual blanking requires blanking for all wells that are to be used for subsequent measurements. The blank correction of the samples is performed by using the single blanking value of the corresponding well on the NanoQuant Plate. For individual blanking, the selection of at least one well is required.



**NOTE:** Average blanking: The selection of at least two wells is required, independent of the number of wells used for the subsequent sample measurement. The measured blank values are averaged and the calculated average value is then used for correcting the sample measurement values.

3. After selecting Individual Blanking or Average Blanking, the plate transport moves out and the user is requested to insert the NanoQuant Plate with the respective blanking samples.
4. Start the blank measurement by selecting **OK**. The incoming values/wells are shown in the information header of the Measurement Status window.
5. After blanking, the blanking results are displayed in a list (see figure below). Enlarge the list by double-tapping.

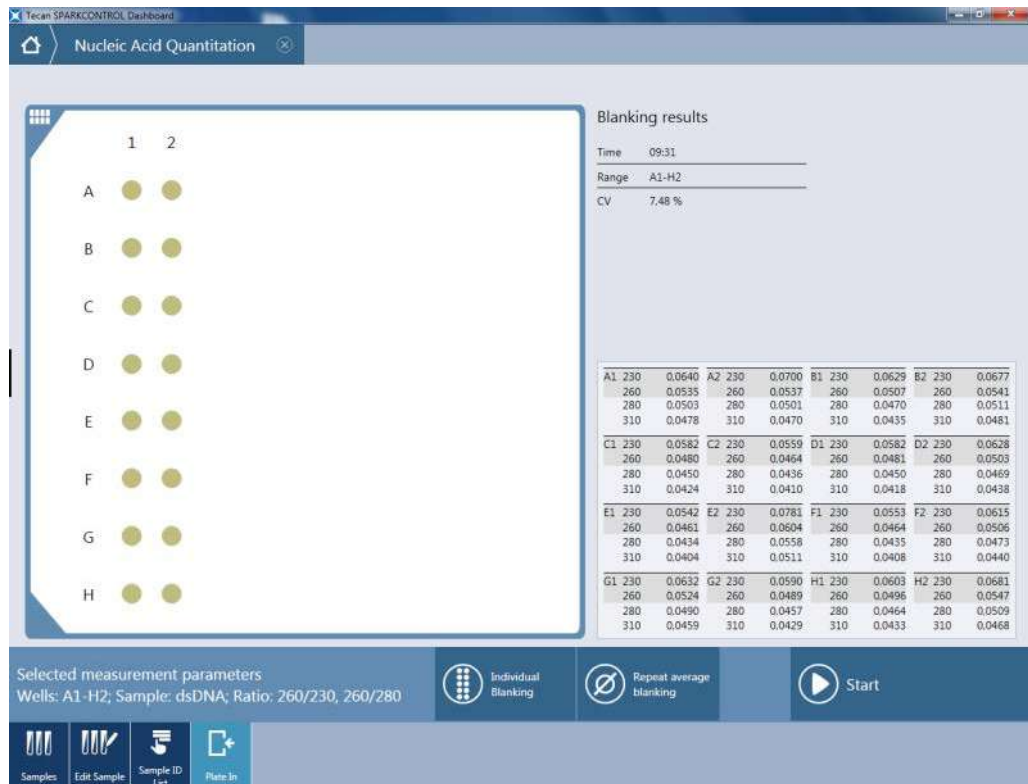

Figure 97: Start Measurement window with blanking results



**NOTE:** The blanking results will be stored with respect to the blanking parameters, wavelength settings and sample type. If one of these parameters is changed, the blanking procedure has to be repeated.

### 16.1.3 Validation Criteria for Blanking Results



**NOTE:** Individual blanking requires no validation criteria.



**NOTE:** Average blanking: A blanking result is valid if the CV (coefficient of variation) of the raw OD values at 260 nm is below a threshold of 10 %. If this criterion is not fulfilled the blanking procedure has to be repeated and the measurement of the samples is prevented. The wells displaying values exceeding the allowed CV-threshold are highlighted.

### 16.1.4 Repeat Blanking



**NOTE:** Repeat the blanking in case of an incorrect blanking measurement or when using new blanking samples.

To repeat individual or average blanking, select the corresponding action button. If necessary, reselect wells that will be used for blanking.



**CAUTION:** If blanking is repeated the current blanking results will be discarded.



**CAUTION:** Opening and closing the NanoQuant application does not lead to loss of the blanking results. By disconnecting the instrument or restarting the software the existing blanking results are discarded.

### 16.1.5 Start Measurement

1. Remove any remaining blanking buffer from the sample positions by wiping the quartz spots with a piece of lint free paper and apply 2 µl of your samples.
2. After individual blanking has been performed, as default the same area used for blanking is selected for measurement. It is possible to reduce the number of wells for the sample measurement, but the number of wells cannot be increased.
3. After average blanking has been performed, the blanking selection is automatically inverted, unless the whole plate was selected. In this case, the whole plate remains selected as default. It is possible to reduce the number of wells or increase the number of wells for the sample measurement beyond the blanking range (max. 16 wells).
4. Insert the plate into the plate carrier.
5. Select **Start**. The measurement is started and the incoming values can be retrieved from the information header of the Measurement Progress window.
6. After the measurement the results are displayed and the plate is moved out automatically (see figure below).
7. To perform a new measurement without closing the app, select **Next Plate**. Click **OK** to close the window. The software returns to the Start Measurement window and a new measurement can be started.

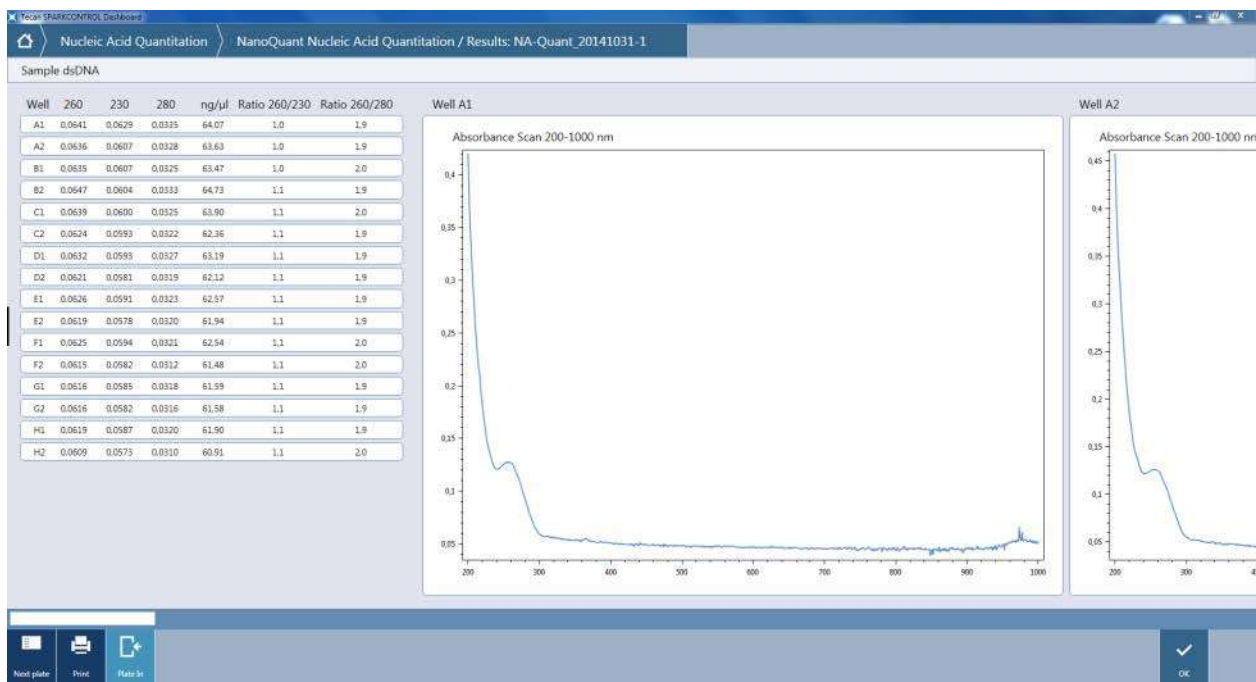

Figure 98: Result window

## Measurement Results

The result window includes the following results:

- Sample type (information header)
- Well position
- Well-specific OD correction values at 260, 280 and 230 nm
- Nucleic acid concentration in ng/μl
- Ratio 260/230 nm
- Ratio 260/280 nm
- Sample ID (if sample IDs are defined)
- Absorbance Scan values from 200 – 1000 nm (in 1nm steps). Use the slider to obtain all of the absorbance scans being measured (see figure below).

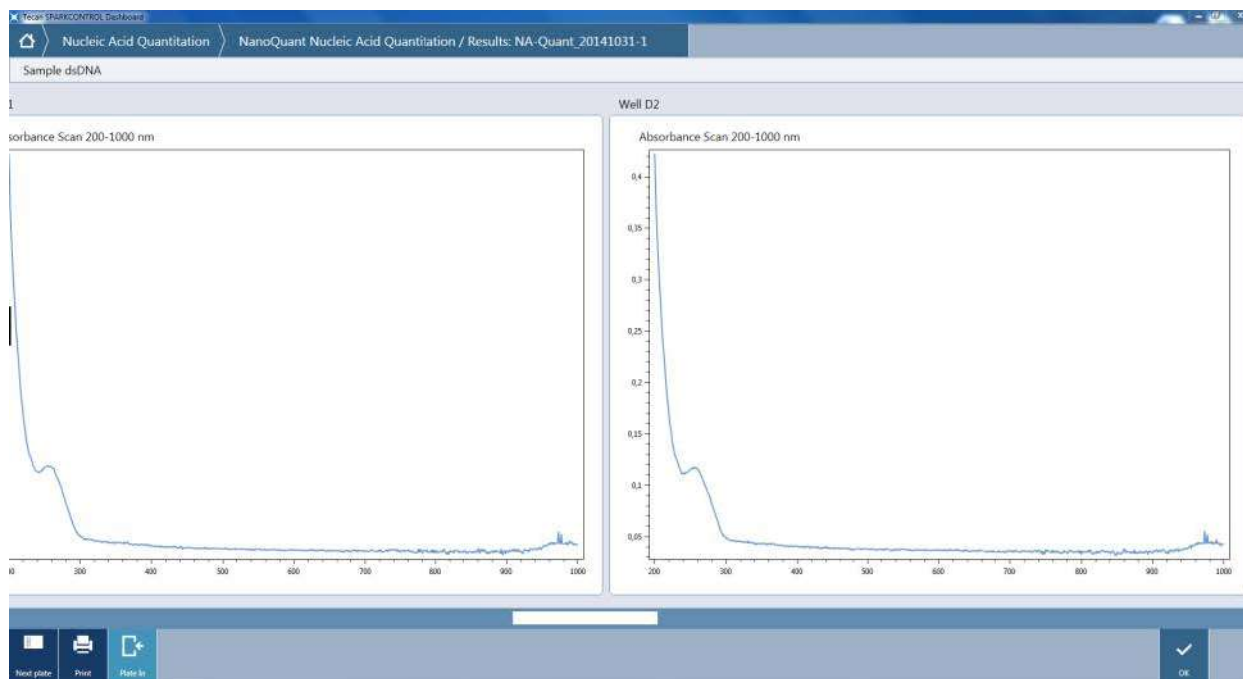

Figure 99: Absorbance scans in the Result window

The final report can be printed in form of a pdf file by selecting Print in the action bar.



**NOTE:** All result data is automatically exported to Microsoft Excel.

## Edit Sample

To define or edit a user defined sample select Edit Sample in the action bar.

It is possible to edit user defined samples only. To define a new sample the name, the extinction coefficient and the ratio wavelength (the wavelength at 280 and/or 230 nm is available for ratio measurements) must be assigned (see figure below).

To add a new sample, select the + button. To delete a sample, select the trashcan button.

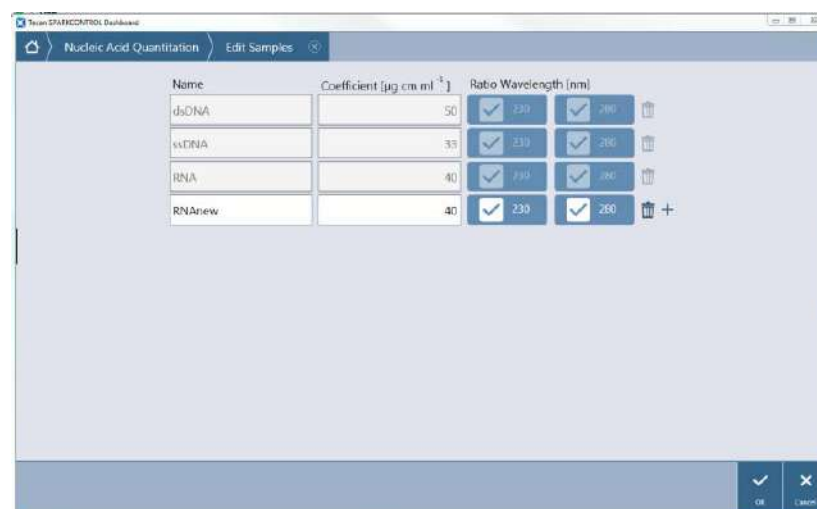

Figure 100: Edit/Add sample

## Sample ID List

With the sample ID list it is possible to assign an ID to each sample on the NQ Plate. To add a sample ID list, select **Sample ID List** in the action bar. Define the sample ID (15 characters at maximum). A sort function allows for ordering of the samples (e.g. A1, A2,... or A1, B1,... ; see figure below). To accept the entries select **OK**, to discard the changes, click **Cancel**.

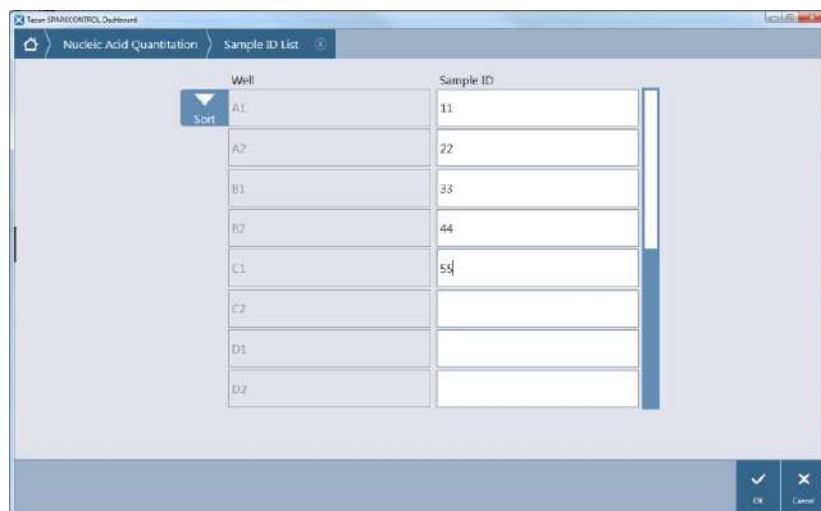

Figure 101: Define a sample ID list

## 16.2 Labeling Efficiency App

The Labeling Efficiency app is designed for working with nucleic acids labeled with fluorescent markers. It provides not only the information about the quantity and the purity of measured samples but also their labeling efficiency by measuring absorbance at the wavelength of the corresponding marker(s). The labeling efficiency measurement can be performed with one or two markers that can be easily selected out of the list of different markers (e.g. Cy3, Cy5, Alexa 555, Alexa 647, etc) included in the app.

The basic set-up and functionality of the Labeling Efficiency App is similar to the Nucleic Acid Quantitation App, please refer to chapter 16.1 Nucleic Acid Quantitation App. In addition please consider the following content specific for the Labeling Efficiency app only.

### Select marker(s)

Select **Markers** in the action bar of the starting window and define a maximum of two markers used for the measurement. The selected marker(s) are provided with a check mark.

### Edit marker

To define or edit a user defined marker select Edit Marker in the action bar.

It is possible to edit user defined markers only. To define a new marker the name, the wavelength (nm), the extinction coefficient and the correction factor for 230, 260 and 280 nm must be assigned.

To add a new marker, select the + button. To delete a sample, select the trashcan button.

## Measurement Results

The result window includes the following results:

- Sample type (information header)
- Well position
- Well-specific OD correction values at 260, 280 and 230 nm
- Nucleic acid concentration in ng/μl
- Marker (dye) concentration in pmol/μl
- Ratio 260/230 nm
- Ratio 260/280 nm
- Sample ID (if sample IDs are defined)
- Absorbance Scan values from 200 – 1000 nm (in 1nm steps). Use the slider to obtain all of the absorbance scans being measured (Figure 99: Absorbance scans in the Result window).

## 16.3 Calculations

### 16.3.1 Calculation of Nucleic Acid Concentration

The calculation of nucleic acid concentration is based on the Lambert-Beer law:

$$A = \epsilon \cdot d \cdot c$$

A Absorbance

$\epsilon$  Molarity Extinction Coefficient [ $\mu\text{g}/1 \text{ cm} \cdot 1 \text{ ml}$ ]

d Distance (path length in cm)

c Concentration [ $\mu\text{g}/\text{ml}$ ]

To correct the OD values due to dirt on the outer surfaces of the quartz lenses, an additional measurement at a reference wavelength is performed automatically with each measurement. A reference wavelength of 310 nm is used.

### 16.3.2 Blanks

#### Correction of Average Blanking value

The average absorbance value at 310 nm measured over all blank wells is subtracted from the average absorbance value at 230 nm, 260 nm and 280 nm. The relative variation of the wells used for average blanking at 260 nm must be below 10 % in order to be able to start a measurement.

$$\text{E.g. } \text{Abs}_{\text{blank average 260 nm}} = \text{Abs}_{\text{260 average}} - \text{Abs}_{\text{310 average}} [\text{OD}]$$

#### Correction of Individual Blanking value

The well-specific absorbance value at 310 nm is subtracted from the corresponding absorbance value at 230 nm, 260 nm and 280 nm. Individual blanking information is stored for each well used and blank-correction of the samples is done with the corresponding single blanking values instead of one average blank. Every well that is to be used for sample measurement needs to be blanked beforehand.

$$\text{E.g. } \text{Abs}_{\text{blank A1}} = \text{Abs}_{\text{260 A1}} - \text{Abs}_{\text{310 A1}} [\text{OD}]$$

### 16.3.3 Samples

Calculations based on Average Blanking: Each well used for sample measurement is blanked with the average blanking value.

$$\text{Abs}_{A1} = (\text{Abs}_{260 A1} - \text{Abs}_{310 A1}) - \text{Abs}_{\text{blank average}} [\text{OD}]$$

$$\text{Abs}_{A2} = (\text{Abs}_{260 A2} - \text{Abs}_{310 A2}) - \text{Abs}_{\text{blank average}} [\text{OD}]$$

Calculations based on Individual Blanking: Each well used for sample measurement is blanked individually with the corresponding blanking value.

$$\text{Abs}_{A1} = (\text{Abs}_{260 A1} - \text{Abs}_{310 A1}) - \text{Abs}_{\text{blank } A1} [\text{OD}]$$

$$\text{Abs}_{A2} = (\text{Abs}_{260 A2} - \text{Abs}_{310 A2}) - \text{Abs}_{\text{blank } A1} [\text{OD}]$$

The absorbance values at 230 nm and/or 280 nm are also corrected by the corresponding absorbance values at 310 nm. The corrected absorbance values are used for the 260/230 and 260/280 ratio calculations.

### 16.3.4 Labeled Samples

The calculation of the concentration of the marker is based on the Lambert-Beer law:

$$A = \epsilon \cdot d \cdot c$$

A Absorbance

$\epsilon$  Extinction Coefficient for the wavelength of the marker [L mol<sup>-1</sup> cm<sup>-1</sup>]

d Distance (path length in cm)

c Concentration [pmol/ $\mu$ l]



## 16.4 NanoQuant Maintenance

In achieving optimal measurement results, the cleaning of the NanoQuant Plate is one of the most essential parts of the entire measurement procedure. There are two procedures for cleaning the NanoQuant Plate:

### 16.4.1 Cleaning Procedure with Ultrasonic Bath

1. Fill an ultrasonic bath with water and place a suitable beaker filled with distilled water into the ultrasonic bath.
2. Switch on the ultrasonic and immerse the lid of the NanoQuant Plate into the beaker, with bobbing movements for about 20 seconds. Take care not to immerse the hinge of the plate.
3. Repeat the procedure with the bottom part of the NanoQuant Plate.
4. Remove any surplus water from the NanoQuant Plate with dry and oil-free compressed air.

### 16.4.2 Cleaning Procedure with Kimwipe

1. Moisten a laboratory Kimwipe with 70 % ethanol and clean the inner and outer surfaces of the NanoQuant Plate.
2. Moisten a piece of cotton or Kimwipe with distilled water and clean both sides of each quartz lens on the NanoQuant Plate.
3. Wipe off any excess liquid with a dry Kimwipe.

After cleaning, store the plate in a dirt-free and lint-free place. No lint, nor any kind of dirt or streaks, should be on the quartz lenses. Any contamination can lead to false measurements. When measuring many different samples one after the other, the quartz wells can be cleaned with a (wet) Kimwipe. The cleaning and maintenance procedures are important in order to prolong the NanoQuant Plate's lifespan and to reduce the need for servicing. It is recommended to store the cleaned NanoQuant Plate in the original storage box.



**CAUTION:** Lint, dirt or fingerprints on the quartz lenses may alter the OD values significantly! Avoid getting dirt on the spacers as this can lead to a change in the length of the light path of the NanoQuant Plate and thus alter the OD values. Apply samples only onto clean quartz lenses!



# 17 Cell Counting in Cell Chips

Cell based assays are an important tool in basic research of academic and life science laboratories as well as in the pharmaceutical industry. The quality check and the counting of cells before cell seeding are common steps for all cell-based applications. This includes identification of live and dead cells that can be easily performed by staining the cells with Trypan blue. Only the dead cells or the cells with a damaged cell membrane will be stained blue and a viable cell will have a clear cytoplasm. Therefore, it is possible to count the cells and determine the viability of a cell culture in one step.

Two ready-to-use apps are available:

- Cell viability: Cell counting and viability checks are performed simultaneously in one measurement. To check the viability Trypan blue has to be added to the cell suspension sample in the rate of 1:1. This dilution step is automatically considered when calculating results.
- Cell counting: Cell counting is performed only, no additive to the cell solution is necessary.



**CAUTION:** Take care that the Trypan blue solution is homogenous, avoid any dye particles because they influence data analysis.

## 17.1 Sample Preparation

1. Unpack the cell chip immediately before use. The cell chips are sterile and individually packaged.
2. The cell chip consists of two sample chambers with a filling volume of 10  $\mu\text{l}$  each. Fill each chamber with a cell sample by using standard pipettes and tips. Avoid liquid drops on the cell chip, air bubbles and scratches in order to guarantee optimal performance.
3. For cell viability checks, Trypan blue has to be added to the cell suspension sample in the ratio of 1:1. This dilution step is automatically taken into account when calculating results.

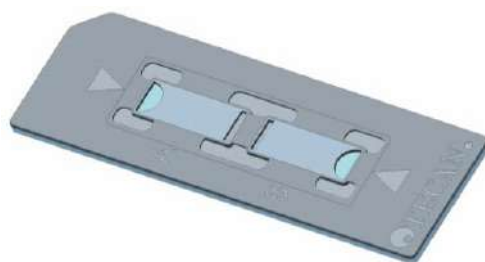

Figure 102: Cell chip



**CAUTION:** Cell chips are disposable and are single-use only. Do not use after the “Use by” date found on the bottom of the packaging.



**CAUTION:** Always wear gloves when handling the cell chip. Avoid any contamination or scratches to guarantee optimal performance.

4. Load up to four cell chips onto the adapter. The cropped corner of the cell chip prevents incorrect orientation.

5. Close the adapter lid. The lid is fixed by a magnetic mechanism. Before closing the adapter lid, visually check that the springs are installed on the inside of the lid to fix the cell chips (see figure below).



Figure 103: Cell chip adapter with springs (dark gray)



**CAUTION:** Don't use the cell chip adapter without springs! Measurement errors may result.

6. Place the cell chip adapter onto the plate carrier of the instrument with the opening in front and the sample position A1 on the upper left side.



**CAUTION:** Before starting measurements, make sure that the adapter for cell chips is inserted correctly with the opening in front and well A1 on the upper left side.

For the cleaning procedure of the adapter and the handling of springs, please refer to chapter 13.3.3 Maintenance and Cleaning of the Cell Chip Adapter.

## 17.2 Cell Viability

### 17.2.1 Starting the Cell Viability App

The Cell Viability App can be started via:

- The **Dashboard** by selecting the corresponding application tile or
- The **Method Editor** by selecting the application from a drop-down list placed top right (-> Select app).

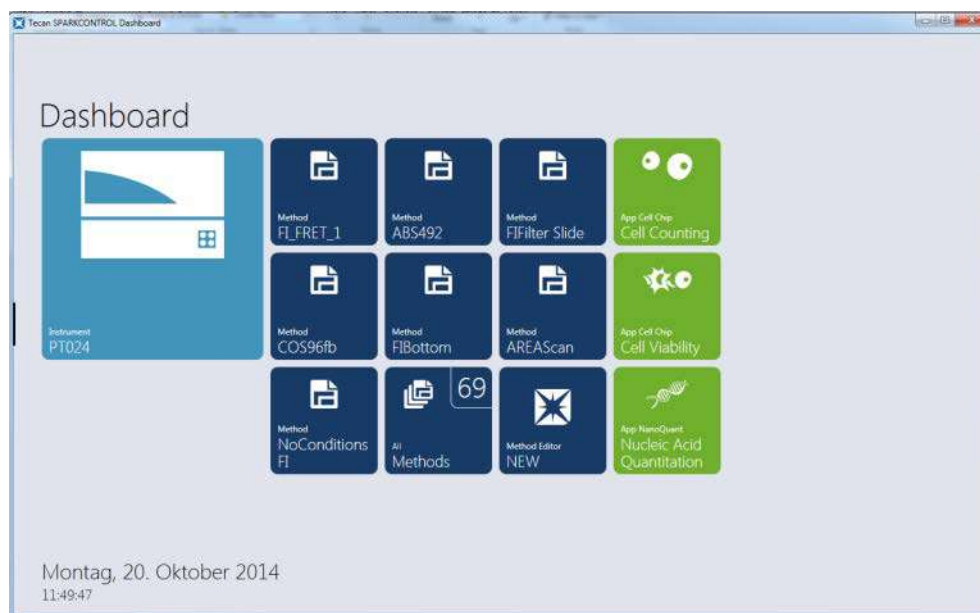

Figure 104: Start the app via Dashboard

### 17.2.2 Sample Selection

1. Select the **Cell Viability** application tile and the start window appears (Figure 105: Cell Viability start window).
2. Select the wells/sample chambers to be used for measurement.
3. Select **Cell size** in the action bar to change the cell size (by default 8-30  $\mu\text{m}$  is selected). Sizes within 4-90  $\mu\text{m}$  can be defined.



**NOTE:** Smaller cell size ranges speed up the image analysis time.

4. Select **Images** in the action bar if more than one image per sample should be taken (by default one image per sample is selected). Alternatively 4 or 8 images per sample can be taken and analyzed.



**NOTE:** At low cell concentrations (smaller  $5 \times 10^5$  cells/ml) and therefore small number of counted cells per taken image, it is recommended to take more than one image to compensate for irregular cell distribution, resulting in more accurate counting data.

5. Mark samples as duplicates by selecting the corresponding cell chip number action button – a symbol appears below the chambers to show that the cell chip contains duplicates (see picture

below). Note that duplicates can be defined within one cell chip only, e.g. the two chambers 1A and 1B can be duplicates, but chambers 1A and 2A cannot be duplicates. Marking samples as duplicates will result in the calculation of the corresponding average values for all analyzed parameters.

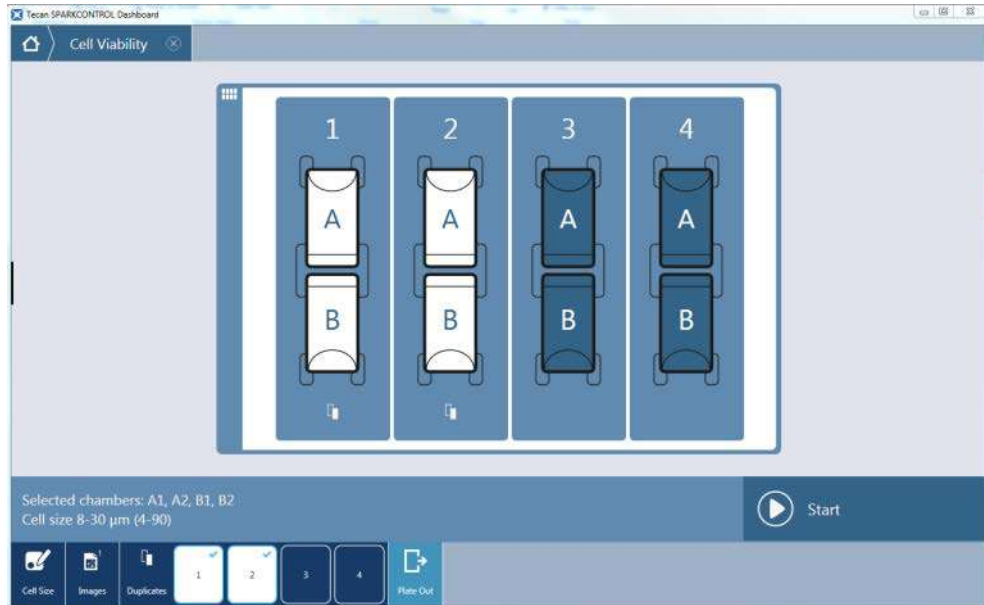

Figure 105: Cell Viability start window

6. Start the cell viability measurement by selecting **Start**. The incoming images and data are displayed as soon as they are available (Figure 106: Measurement progress window).

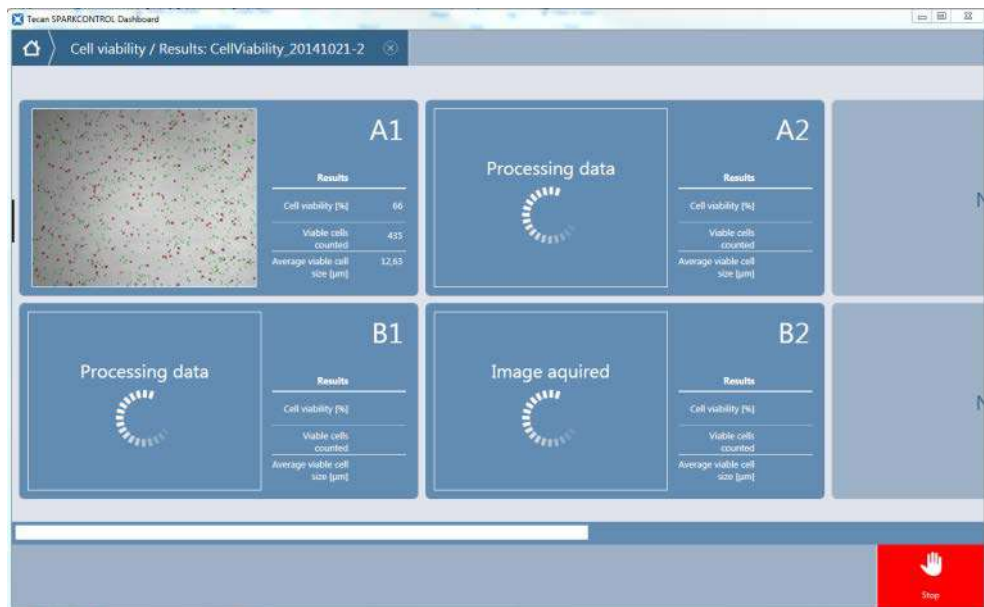

Figure 106: Measurement progress window

### 17.2.3 Measurement Results

1. Images and data are displayed in the result window (see figure below). Live cells are displayed in green whereas dead cells are shown in red. A summary of the corresponding data (cell concentration, counted cells and the average cell size) is displayed to the right of to the image.

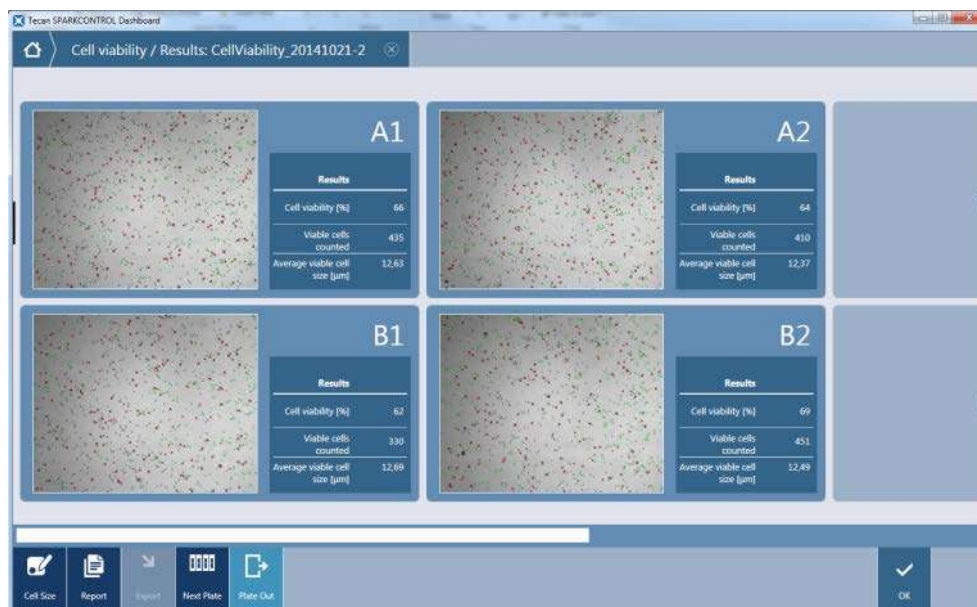

Figure 107: Cell Viability result window

2. Select Cell Size in the action bar to choose a new cell size range and recalculation of data based on the already taken images is performed. After recalculation the new data is presented in the result window.

- Select Report in the action bar to view the report. The report includes all calculated data for each measured sample, the images as well as the histograms of all samples. If duplicates are defined the average data is shown too. The report is automatically saved after the measurement to the default folder (C:\Users\Public\Documents\Tecan\SparkControl\PDFReport). Click Print to send the report to the default printer (pdf-format, see figure below).

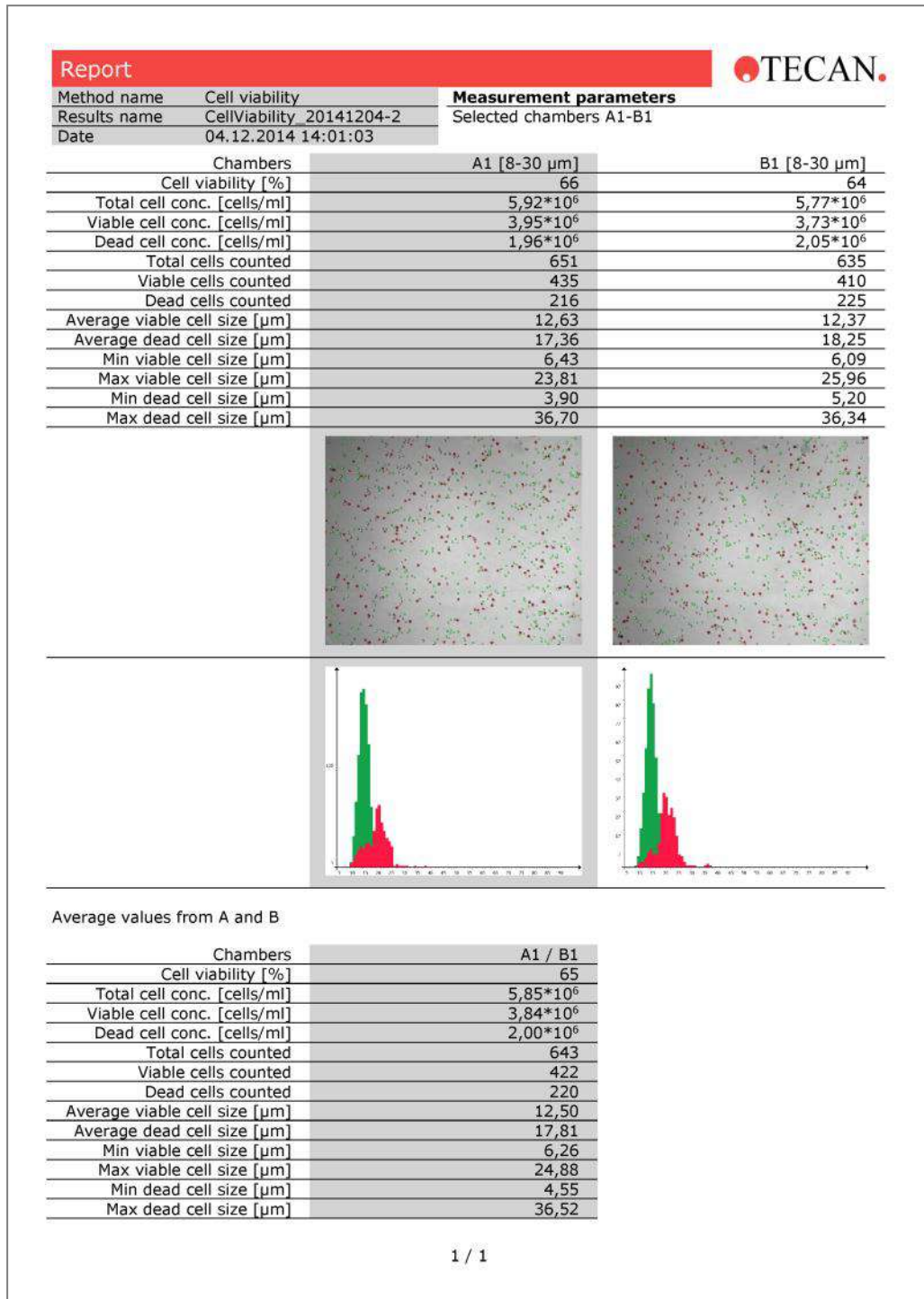

Figure 108: PDF report



4. After a measurement an Excel file with all data is generated and saved according to the export path (C:\Users\Public\Documents\Tecan\SparkControl\Export\xlsx as default). In addition, all the images can be found under C:\Users\Public\Documents\Tecan\SparkControl\Images (default path) or the path defined by the user. For the report, go to C:\Users\Public\Documents\Tecan\SparkControl\PDFReport.
5. If a recalculation of data is performed after the measurement, new data is not exported automatically. Select the **Export** button to trigger the export of the data including the images and the report.



**CAUTION:** Recalculated data is not saved automatically. Select Export in the action bar after the recalculation procedure to avoid data loss.

6. To perform a new measurement without closing the app select the action button **Next Plate** before leaving the window by selecting **OK**. In that case, the software returns to the start window and a new measurement can be started.
7. For a full-screen view of the image only, double-click the desired image. For a detailed view of image and data, click the **Results**. The view is enlarged and all available result data is displayed.

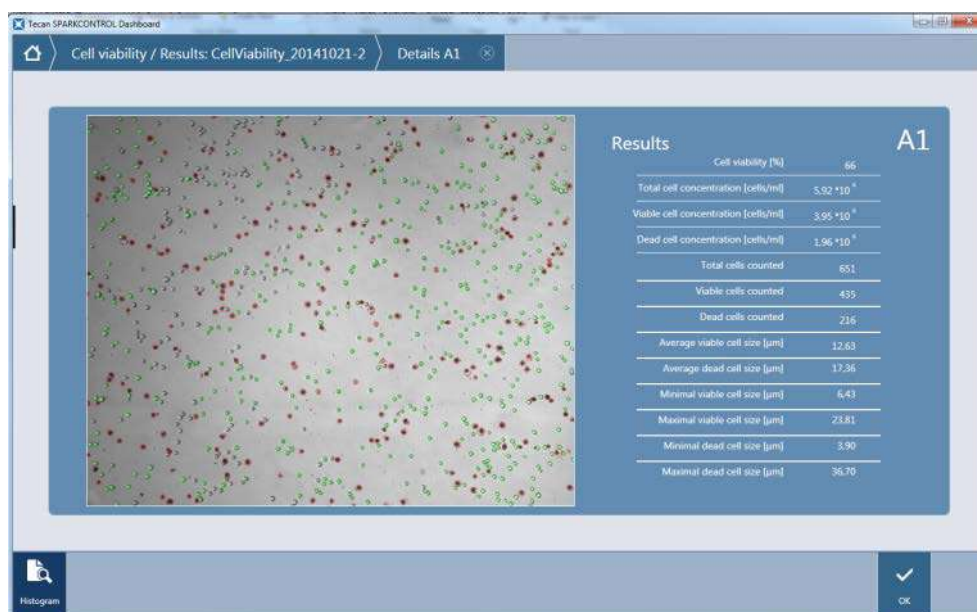

Figure 109: Detailed result window

## 17.2.4 Cell Histogram

By selecting **Histogram** in the action bar the correlated histogram is displayed. The cell size is plotted against the number of cells. Live cells are presented by the green bars and dead cells by the red bars.

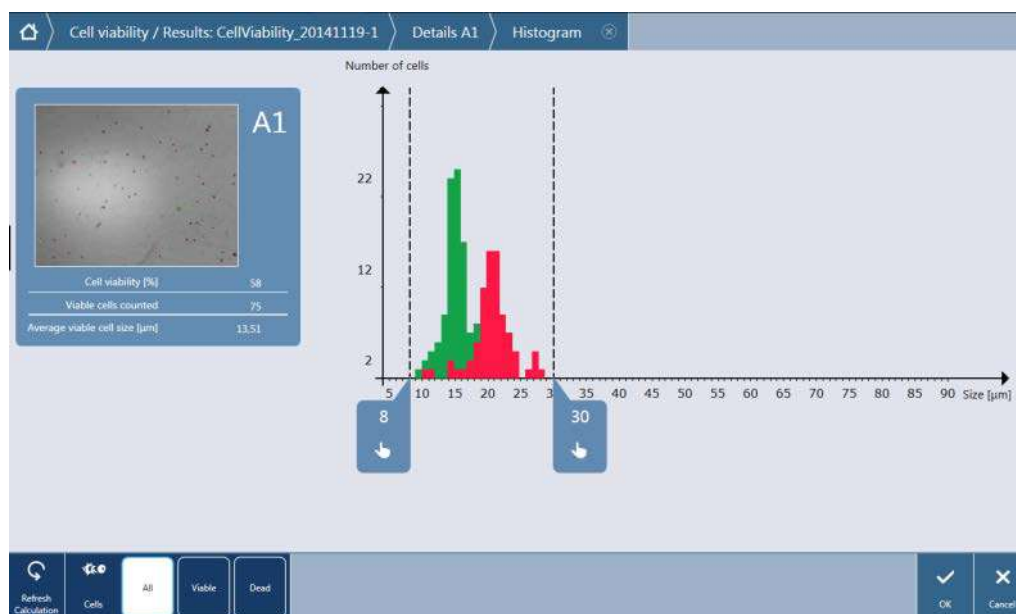

Figure 110: Histogram

Modify the histogram view by selecting one of the following action buttons: **All**, **Viable** or **Dead**.

Move the sliders to change the cell size and select **Refresh Calculation** in the action bar. Displayed data as well as histogram will be refreshed accordingly.

## 17.2.5 Duplicates

Data calculation is performed for each sample separately. In the detailed result view of a sample with an existing duplicate (e.g. for slide one: A1 or B1) beside the single data the average data of the duplicates is shown too.

## 17.3 Cell Counting App

The Cell Counting App is designed for counting cells without further classification into viable and dead cells. In an image, all the counted cells are highlighted in blue. The Cell Counting App contains the same functional graphical elements as the Cell Viability App (please refer to chapter 17.2 Cell Viability).

# 18 Cuvette App

The Cuvette App is designed for routine absorbance or absorbance scan endpoint measurements performed in a cuvette within a cuvette port. Each measurement starts with the measuring of a blank value that can be used for the automatic blank correction of the measured samples.

## 18.1 Prepare Instrument and Blanking

1. Select the **Cuvette** application. Within the **Absorbance** window (default selection) define the measurement wavelength and the number of flashes used for the measurement (see figure below) For absorbance scan, select the **Absorbance Scan** action button and define the measurement wavelength range.



Figure 111: Selecting detection mode

2. Select **Blanking**. A user intervention window for emptying the cuvette port is displayed.
3. Empty the cuvette port and select **OK**.



**NOTE:** The Prepare Instrument measurement has to be performed everytime a measurement with new measurement parameters is started. Please make sure that the cuvette port is empty.

4. Insert a cuvette for blanking and confirm the corresponding user intervention by selecting **OK**. The blanking measurement is performed and the blanking result is part of the Result window (Figure 112: Result window during a measurement).

## 18.2 Measurement

1. After blanking, remove the cuvette for blanking from the cuvette port and insert a cuvette with sample. De-select **Apply blanking** if the automated blank correction should not be performed automatically.
2. Start the measurement by selecting **Start**. The measured result is displayed within the Result window (Figure 112: Result window during a measurement). To measure a new sample remove the previous cuvette from the cuvette port, insert the new one and continue with **Start**. The new measured result is added to the Result window.

Blanking results		Cuvette	Measured	Blank	Blanked data
Time	12:28	1	1,2643	0,0575	1,2068
Value	0,0575	2	1,5653	0,0575	1,5078
		3	1,7968	0,0575	1,7394

Selected measurement parameters  
Measurement wavelength: 492 nm

04.30.2015 12:28

Repeat Blanking Start

Edit Parameters Print View

Figure 112: Result window during a measurement

3. Select **View** to change between the list and the graphic view of the measured results.
4. If needed, repeat blanking during the current measurement session via **Repeat blanking**. The old blanking value is discarded and the new blanking value is valid for all the following measurement. For each repetition, a new result sheet is generated indicated by the tabs placed on the right side of the Result window (Figure 113: Result window with multiple result sheets). Each tab is provided with the date and time of the respective blanking readout.

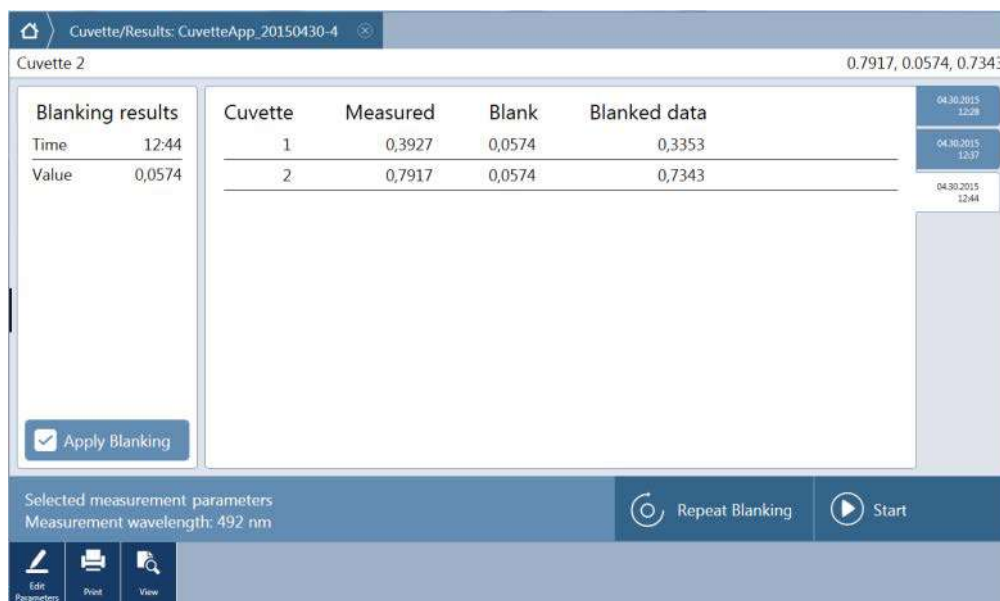

Figure 113: Result window with multiple result sheets

5. After a measurement an Excel file with all data is generated and saved under C:\Users\Public\Documents\Tecan\SparkControl\Export\xlsx (default path) or the path defined by the user.
6. The final report can be printed as a pdf file. Select Print to send the report to the default printer.
7. To edit the measurement parameters select **Edit Parameters**. The software returns to the Cuvette App starting screen, a new measurement session can be started.



**NOTE:** The selection Edit Parameters will close the current measurement session. The Prepare Instrument measurement has to be repeated.



# 19 Troubleshooting

## 19.1 SparkControl Errors and Warnings

If an error cannot be resolved or reoccurs regularly, contact your local Tecan service representative.

Error	Description	Possible solution / workaround
<b>Device related errors</b>		
Initialization error for motor 'motor'	Actuator failure while initializing	Report to Tecan. Switch off/on device and retry.
Steploss error for motor 'motor'	Actuator failure; checked after measurement	Report to Tecan (results not trustworthy). Switch off/on device and retry.
Motor 'motor' not initialized	Actuator failure; checked before measurement	Report to Tecan. Switch off/on device and retry.
Movement position 'position' not found	Logical position not found; configuration error	Report to Tecan
Movement for motor 'motor' timed out!	Actuator failure	Report to Tecan
Error reading temperature sensor	Temperature sensor failure	Report to Tecan
Command 'command' is not valid	Error in computer - device communication protocol	Report to Tecan
Parameter 'parameter' is missing	Error in computer - device communication protocol	Report to Tecan
Module 'module' with number 'number' had an error 'add. text'	Device error (module)	Report to Tecan
Submodule 'module' had an error 'add. text'	Device error (sub-module)	Report to Tecan
CAN Receive timeout from Module 'module'	Device error (Timeout on CAN bus)	Report to Tecan
CAN communication error	Device error (CAN bus)	Report to Tecan
SPI timeout	Device error (SPI)	Report to Tecan
I2C timeout	Device error (I2C)	Report to Tecan
SCI timeout, Submodule 'sub-module'	Device error (SCI)	Report to Tecan
Injector timeout	Timeout while communication to injector module	Report to Tecan. Switch off device. Check injector cabling. Switch on device and retry.

Error	Description	Possible solution / workaround
Injector communication error	Communication error device - injector module	Report to Tecan. Switch off device. Check injector cabling. Switch on device and retry.
Answer 'answer' from internal Command 'command' wrong 'add. text'	Device error	Report to Tecan
Buffer 'buffer' is out of memory 'add. text'	Device error	Report to Tecan
Buffer 'buffer' is out of memory 'add. text'	Device error	Report to Tecan
Sending the data over USB failed ('number' retries)	Device error while sending data over USB channel to computer	Report to Tecan. Switch off device. Check USB cabling. Switch on device and retry. If error is related to heavy USB traffic or heavy load on computer it may be helpful to close other applications.

#### Communication related errors (computer to device)

Not able to connect to the communication service	Unable to connect to service	Switch off/on device. Restart services by clicking the tray icon "SPARKCONTROL Agent" with right mouse button (context menu) and selecting "Restart Services"
Lost connection to Instrument Server. Terminate application	Device connection lost	Close application (Dashboard or Method Editor). Switch off/on device. Restart services by clicking the tray icon "SPARKCONTROL Agent" with right mouse button (context menu) and selecting "Restart Services"
No instrument found	Device not present	Switch on device
Instrument not free	Device blocked by other process	Be sure that no other program uses the device. Eventually restart computer.
Instrument could not be acquired	Device blocked by other process	Be sure that no other program uses the device. Eventually restart computer.
Instrument is busy	Device busy	Wait until device becomes free.
Error occurred: 'command'	Device reports an error on 'command'	Report to Tecan
Unexpected message received: 'response'	Unexpected response from device received	Report to Tecan
Unexpected response format: 'response'	Unexpected response format detected	Report to Tecan



Error	Description	Possible solution / workaround
Checksum mismatch in received command	Checksum of response message from device not correct	Report to Tecan
No configuration found	Device not configured correctly	Report to Tecan
<b>Measurement related errors</b>		
Instrument has no lid lifter defined	Device not configured correctly	Report to Tecan
Optimal Gain could not be found	Unable to find optimal gain	Use manual gain
Strongest well signal could not be found	Unable to find optimal gain	Use manual gain
Signal too low. Gain could not be calculated	Unable to find optimal gain	Use manual gain
Unable to find optimal Z-position after n retries	Unable to find optimal Z-position	Use manual Z-Position
No reference blank selected	No reference blank well for FP measurement given	Select reference blank well
Blank well 'Id' is not selected in the Plate strip	No reference blank well for FP measurement given	Select reference blank well
No reference well selected	No reference well for FP measurement given	Select reference well
Signal well 'Id' is not selected in the Plate strip	Signal well for FP measurement not given	Select signal well
Signal of reference well too low, choose another one	Signal of reference well too low	Use another well
Invalid G-Factor, signal of reference well is too low.	Unable to determine G-factor	Choose another well
Dark counts too high	Dark counts too high	Report to Tecan
Dark value too high: Darkvalue='value', Limit='limit'	Dark counts too high	Report to Tecan
Lid Check error	Lid check error	Device gets too much light (from direct sun light or from sample)
The lid check had an error! Value='value', Limit='limit'	Lid check error	Device gets too much light (from direct sun light or from sample)
Low 'add. Text' signal error	Lamp low error (or too low signal)	Report to Tecan. Switch off/on device and retry.
'Add. Text' signal overflow error	Overflow error	Too much signal; could be a device error. Or: too much signal from sample (reduce gain)
Cancel of method failed	Unable to stop measurement	Try again
Pause of method failed.	Unable to pause a measurement (kinetic)	Retry; Report to Tecan.

Error	Description	Possible solution / workaround
Method can't be started because method 'method' is still pending on instrument 'device'.	Unable to start a method because another one is still pending	Wait until device is free
Method can't be started because instrument 'device' is in use.	Unable to start a method because device is in use	Wait until device is free
Error occurred executing method 'method'	Unspecific error occurred while executing a method	Retry; Report to Tecan.
Lid already taken	Lid already taken by lid-lifter	Move plate-out and in again
Autofocus Error: No peak found!	Application/Device error	Check the plate/Report to Tecan

### General errors

Database doesn't exists!	Cannot open database	Re-install program
WCF call failed after 'n' retries	Unspecific error occurred while sending a message from Dashboard or Method Editor to server	Close application (Dashboard or Method Editor). Switch off/on device. Restart services by clicking the tray icon "SPARKCONTROL Agent" with right mouse button (context menu) and selecting "Restart Services"
Not able to find given printer	Unable to find printer	Check printer settings
There is not enough memory available for image processing	Memory allocation error while image processing	Close other applications. Equip computer with more memory
Memory allocation failed	Memory allocation error while image acquisition or image processing	Close other applications. Equip computer with more memory
Imaging Server not found	Unable to connect to imaging server	Close application (Dashboard or Method Editor). Switch off/on device. Restart services by clicking the tray icon "SPARKCONTROL Agent" with right mouse button (context menu) and selecting "Restart Services"
The PDFX directory: 'directory' doesn't exist	Directory for the plate definition files not existent (or not accessible)	Re-install program

Error	Description	Possible solution / workaround
Camera initialization failed	Unable to initialize camera module	Close application (Dashboard or Method Editor). Switch off/on device. Restart services by clicking the tray icon "SPARKCONTROL Agent" with right mouse button (context menu) and selecting "Restart Services". If problems persists, contact Tecan.
Instrument 'device' is defect.	Defective device detected	Report to Tecan
<b>Injector related errors</b>		
Injector carrier is inserted	Injector carrier inserted (but should not be)	Remove injector carrier
Injector carrier is not inserted	Injector carrier is not inserted (but should be)	Insert injector carrier
Plate is not inserted	No plate detected	Insert plate
The injection volume would be greater than the maximum capacity of the wells of the selected microplate. Injection aborted.	Fill-volume too high	Decrease volume
Injection is not possible with a plate cover.	Injection not possible	Remove plate cover (and adjust setting in Plate strip)
Injector 'injector' is not primed. Please prime the injector.	Injector not primed	Prime injector before usage
<b>Filter related errors</b>		
Filter 'filter' - Maximum characters of filter description is 'n'	Filter description too long	Reduce text
Maximum characters of filter slide description is 'n'	Filter description too long	Reduce text
Filter 'filter' - Bandwidth must be in the range of 5 - 100 nm	Bandwidth out of range	Define correct bandwidth
Filter 'filter' - Wavelength must be in the range of 230 - 900 nm	Wavelength out of range	Define correct wavelength
Defined filter was not found.	Requested filter could not be found	Equip filter slide with requested filter
Filter not found 'filter'	Requested filter could not be found	Equip filter slide with requested filter
Filter 'filter' not inserted!	Required filter not inserted	Insert correct filter

<b>Error</b>	<b>Description</b>	<b>Possible solution / workaround</b>
Defined mirror was not found.	Mirror could not be found	Report to Tecan (if user-defined filter: Equip and define with correct mirror)

# Index

<b>3</b>	
3D Scan.....	93
<b>A</b>	
Absorbance .....	127
Absorbance Scan .....	127
Absorbance System .....	127, 129
Action Bar.....	84
Action Buttons .....	84
Expandable.....	84
Actions.....	72
Area Scan.....	82
<b>B</b>	
Bandwidth.....	143
Blocking.....	143
Breadcrumbs .....	84
<b>C</b>	
Cell Chips .....	194
Check-and-Go .....	88
Cleaning and Maintenance.....	53
Comment Strip.....	75
Condition Strip.....	74
Control Bar .....	66
<b>D</b>	
Dashboard.....	83
Data Display .....	90
Detection Strips .....	72
Disinfection	
Instrument.....	54
Procedure.....	55
Safety Certificate .....	55
Disinfection Solutions .....	54
Disposal	
Instrument.....	57
Operating Material .....	56
Packaging Material.....	56
<b>E</b>	
Expand Button.....	84
<b>F</b>	
File menu.....	63
Flash Luminescence.....	101
Fluorescence .....	141
Fluorescence Bottom Module.....	146, 163
Fluorescence Intensity.....	141
Fluorescence Intensity Module.....	142
Fluorescence Intensity Scan Strip .....	161
Fluorescence Polarization .....	142
Fluorescence Polarization Module.....	163
Fluorescence Polarization Optics .....	163
Fluorescence Resonance Energy Transfer .....	141
Fluorescence Resonance Energy Transfer (FRET)	
.....	141
Fluorescence Time Resolved (TRF).....	141
Fluorescence Top Module .....	144
FRET .....	141
Full width at half maximum .....	143
FWHM .....	See Full width at half maximum
<b>G</b>	
G-Factor Calculation.....	163
Glow type Luminescence.....	101
Graph View.....	90
<b>H</b>	
Help menu .....	64
<b>I</b>	
incubation position.....	44, 72, 73, 219
Info Pane .....	78
Injection Strip.....	73
Instrument	
Decontamination/Disinfection .....	54
Dimensions .....	22
Disinfection Procedure.....	55
Disinfection Solutions .....	54
Installation .....	32
Power Requirements .....	32
Preparing for Shipping.....	38
Safety Certificate .....	55
Specifications .....	51
Switching On .....	37
Instrument Control .....	87
Instrument Menu.....	63
Integration Time.....	111
<b>K</b>	
Kinetic Loop Strip .....	75
<b>L</b>	
Lid Lifter.....	44
Light Attenuation.....	111
Liquid Spills .....	53
Luminescence .....	101
Optics .....	104
Luminescence / Flash.....	101
Luminescence / Glow type.....	101
Luminescence / Multicolor .....	101
Luminescence Filters.....	103
Luminescence Module/ Enhanced.....	103
Luminescence Module/ Standard .....	102
Luminescence Scan/ .....	102
Luminescence Specifications .....	112
<b>M</b>	
Maintenance	
Instrument.....	53
Measurement Progress .....	90
Measurement Results.....	94
Measurement Types	
Conditional	
Signal-triggered .....	80
Time-triggered .....	79
Endpoint .....	78

Kinetic .....	78	Shaking .....	44
Multi-label .....	79	Shaking Strip .....	72
Plate-wise .....	78	Shipping the Instrument .....	38
Single-label .....	79	Software	
Well-wise .....	78	Installation .....	61
Menus .....	63	Starting .....	61
Method		System Requirements .....	59
Starting .....	88, 94	Uninstall/Repair .....	61
Method File Explorer .....	94	SparkControl Settings .....	95, 100
Move Plate Strip .....	75	Specifications .....	51
Multicolor Luminescence .....	101	Spills .....	53
Multifunctionality .....	16	Start tile .....	89
Multiple Instruments .....	88	Strip / Luminescence .....	106
Multiple Reads per Well .....	81	Strip / Luminescence Scan .....	110
<b>N</b>		Strip / Multicolor Luminescence .....	108
Navigation Bar .....	84	Strips	
<b>O</b>		Hierarchy of .....	76
Onboard Control Buttons .....	18	Indenting and Outdenting of .....	77
Optimal Read .....	82	Subpack .....	33
<b>P</b>		Switching the Instrument On .....	37
Packaging Material		System Requirements .....	59
Disposal .....	56	<b>T</b>	
Returning .....	56	Tiles .....	83
Plate .....	67, 71	Time-Resolved Fluorescence Intensity Strip .....	158
Plate Carrier		Toolbar .....	65
Transport Lock .....	35	Transport Locks	
Plate Control .....	43	Removal .....	35
Plate layout .....	68	<b>U</b>	
Plate Strip .....	67, 71	Unpacking & Inspection .....	32
Plate View .....	90	User Intervention Strip .....	75
Power Requirements .....	32	User Profile .....	16
<b>Q</b>		<b>V</b>	
Quality Control		View Menu .....	63
Absorbance .....	138, 217	Voltage Range .....	32
Luminescence .....	113	<b>W</b>	
<b>R</b>		Wait Strip .....	73
Rear View .....	20	Well Strip .....	71
<b>S</b>		Workflow Pane .....	76
Safety Certificate .....	55	<b>Z</b>	
Safety Precautions .....	13	Z-Position .....	44
Scans .....	92		

# Tecan Customer Support

If you have any questions or need technical support for your Tecan product, contact your local Tecan Customer Support organization. Go to: <http://www.tecan.com/customersupport> for contact information.

Prior to contacting Tecan for product support, prepare the following information for the best possible technical support (see name plate):

- Model name of your product
- Serial number (SN) of your product
- Software and software version (if applicable)
- Description of the problem and contact person
- Date and time when the problem occurred
- Steps that you have already taken to correct the problem
- Your contact information (phone number, fax number, e-mail address, etc.)





## Declaration of Conformity

We, TECAN Austria GmbH herewith declare under our sole responsibility that the product identified as:

**Product Type:** Microplate Reader  
**Model Designation:** SPARK 10M, SPARK 20M

**Article Numbers:** 30086375, 30086376

**Address:** Tecan Austria GmbH  
Untersbergstr. 1A  
A-5082 Grödig, Austria

is in conformity with the provisions of the following European Directive(s) when installed in accordance with the installation instructions contained in the product documentation:

**2014/30/EU – EMC Directive**  
**2006/42/EC – Machinery Directive**  
**2011/65/EU – RoHS Directive**

and that the standards referenced below were taken in consideration:

EN 61010-1:2001/AC:2002	Safety requirements for electrical equipment for measurement, control, and laboratory use -- Part 1: General requirements
EN 60825-1:2007	Safety of laser products -- Part 1: Equipment classification and requirements
EN 61326-1:2013	Electrical Equipment for Measurement, Control, and Laboratory Use - EMC Requirements -- Part 1: General requirements
EN ISO 12100:2010	Safety of machinery - General principles for design - Risk assessment and risk reduction
EN 50581:2012	Technical documentation for the assessment of electrical and electronic products with respect to the restriction of hazardous substances